

VEDA MC

Operating Instructions

EtherCAT option



Table of contents

1. Hardware Description	3
2. Wiring Instructions	3
3. VF-101 inverter related parameter description	4
3.1. VF-101 setting parameters	4
3.2. VF-101 communication control group parameters	5
3.3. VF-101 Communication monitoring group parameters	6
4. Communication Instructions	7
4.1. PDO data description	7
4.2. Mailbox data SDO	7
5. Operation example	7
5.1. Controlling VF-101 inverter with Beckhoff controller	7
5.2. Use OMRON controller to control VF-101 inverter	12

1. Hardware Description

This communication card cooperates with the EtherCAT master station, which can realize the command and status acquisition of the inverter, so as to achieve the purpose of driving the inverter. The schematic diagram of its appearance is shown below.

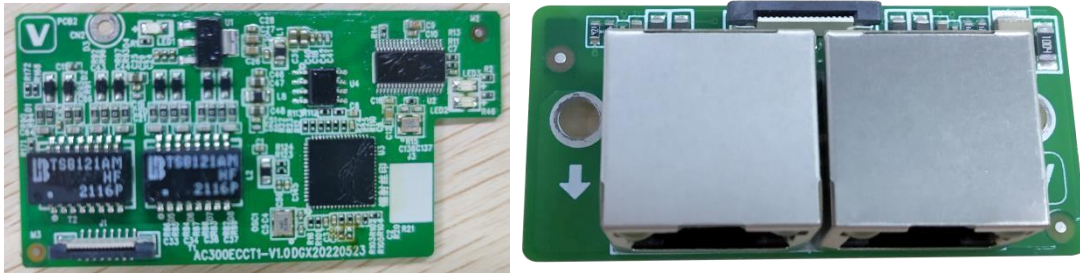

Figure 1.1 VF-101 EtherCAT communication extension card

There are multiple LEDs on this communication card to indicate the communication status of the extension card, and Table 1.1 shows the description of each LED indicator.

Table 1.1 LEDs Indicator light description

Indicator light	Function	Describe
LED1	Power Indicator	1. On means the power supply is normal; 2. Off means the power supply is abnormal;
LED2	Program running indicator	1. Blinking means normal (slower blinking when OP, faster blinking when non-OP). 2. Always on or off means the program is running abnormally;
LED3	Error indicator	1. Constant light indicates a board error; 2. Continuous slow flashing means EEPROM loading error; 3. Two consecutive flashes indicate abnormal communication with frequency inverter; 4. After flashing for 3 times, it is always off to indicate an error in reading and writing the inverter; 5. Four consecutive flashes indicate that the main station is disconnected; 6. Five consecutive flashes indicate that the communication card test byte fails;

2. Wiring Instructions

The topological structures supported by EtherCAT include bus type, star type, tree type, etc., and the device connection is very flexible. The bus type connection is a common connection, and the connection topology is as follows (VF-101 EtherCAT extension card right RJ45for input, left RJ45for output).

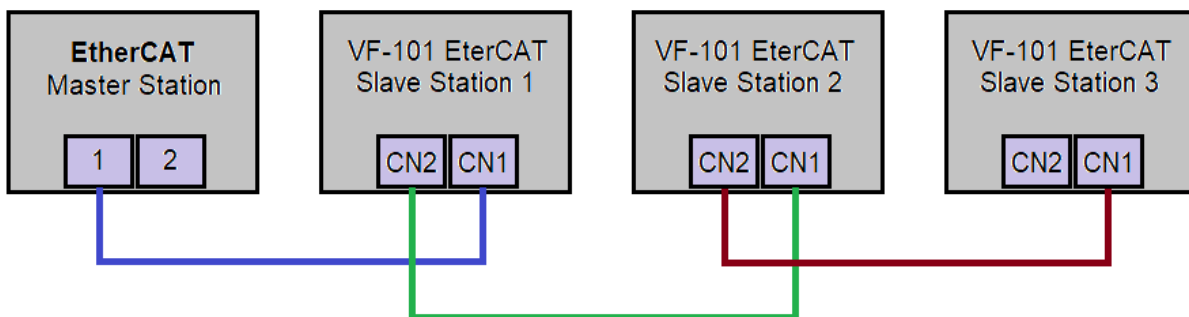

Figure 2.1 EtherCAT bus type wiring topology

3. VF-101 inverter related parameter description

3.1. VF-101 setting parameters

Table 3.1 VF-101 Function code setting

Function code t	Name	Set range	Set value	Meaning
F01.01	Run command selection	0: keyboard given 1: Terminal given 2: RS485 given 3: Optional card given 4: Terminal switching command given	3	The run command is given by the EtherCAT card
F01.02	Frequency given source channel	0: keyboard number given 1: Keyboard analog potentiometer given ... 10: optional card	10	The frequency command is given by the EtherCAT card
F01.11	Upper limit frequency source selection	Select the given source of the upper limit frequency of the inverter. 0: upper limit frequency digital given 1: reserved 2: Voltage analog VS given 3: Current/voltage analog AI given 4: Current analog quantity AS given 5: Terminal pulse PUL given 6: RS485 communication given 7: Optional Cards	-	If you want to use the EtherCAT card to limit the upper limit frequency, you need to set this to 7
F03.41	Torque command given	0: keyboard number 1: keyboard potentiometer given ... 7: Optional card	-	If the torque command is to be given by the EtherCAT card, set it to 7
F03.54	Torque control forward speed limit selection	0: Function code F03.56 setting; 1: reserved ... 7: Optional card*F03.56	-	Set to 7 if the speed needs to be limited by the EtherCAT card
F03.55	Torque control reverse speed limit selection	0: Function code F03.57 set up; 1: reserved ... 7: Optional card*F03.57	-	Set to 7 if the speed needs to be limited by the EtherCAT card
F03.56	Torque control forward rotation maximum speed	0.0~100.0%	-	Relative maximum output frequency (F01.10)
F03.57	Torque control reverse maximum speed	0.0~100.0%	-	Relative maximum output frequency (F01.10)
F12.32	Pn card and inverter disconnection processing method	0: do not detect 1: Alarm and free parking 2: warn and continue		The processing method after the EtherCAT card detects that it is disconnected from the control board (Ebus4/A.buS)
F12.41	Site alias	1-247	1	
F12.43	Master-slave communication fault action	0: do not detect 1: Alarm and free parking 2: warn and continue	-	When the master-slave communication fails, the processing method (the PLC is disconnected from the device or the PLC downloads the program or the PLC is in the stop state, reports Ebus3/A.buS)
F12.50	Extension card communication disconnection processing method (inverter processing)	Ones place: EX-A disconnection handling Tens place: EX-B disconnection processing 0: do not detect 1: Alarm and free parking 2: warn and continue	-	The communication between the EtherCAT card and the inverter is faulty, and the processing method is selected. (The inverter itself detects and processes it, and reports Ebus1/A.buS)

3.2. VF-101 Communication Control Group Parameters

Table 3.2 VF-101 Communication control group address description

Address definition	Function Description	Description of data meaning	R/W characteristics
0x3100	Communication given frequency	Unit 0.01Hz, such as 5000 corresponds to 50.00Hz	R/W
0x3101	Communication command setting	0: no command 1: Forward running 2: Reverse operation 3: Forward jog 4: reverse jog 5: Decelerate to stop 6: Free stop 7: fault reset 8: run the forbidden command 9: run the allow command	R/W
0x3104	Communication given upper limit frequency (0.01Hz)	Unit 0.01Hz	R/W
0x3105	Communication torque setting (0.1%)	Unit 0.1%	R/W
0x3106	Torque control positive maximum frequency limit (0.1%)	Unit 0.1%	R/W
0x3107	Torque control reverse maximum frequency limit (0.1%)	Unit 0.1%	R/W
0x3108	Communication given PID setting value (0.1%)	Unit 0.1%	R/W
0x3109	Communication given PID feedback value (0.1%)	Unit 0.1%	R/W
0x310A	Voltage-frequency separation voltage value setting (0.1%)	Unit 0.1%	R/W
0x310B	Tension setting	0~maximum tension	R/W
0x310C	Roll diameter setting	0~Maximum roll diameter	R/W
0x310D	Line speed setting	0~Maximum line speed	R/W
0x310E	Acceleration time 1	Set the unit through function code F01.21	R/W
0x310F	Deceleration time 1	Set the unit through function code F01.21	R/W
0x3111	Torque current component	0~4000(corresponding to 0.0%~400.0%)	R/W
0x3112	Torque filter time	0~6000(correspond0.000-6.000s)	R/W
0x3113	Tension PID feedback	0~1000(corresponding to 0.0%~100.0%)	R/W
0x3114	Communication given jog torque limit	0~4000(corresponding to 0.0%~400.0%)	R/W
0x3115	Communication given generator torque limit	0~4000(corresponding to 0.0%~400.0%)	R/W

3.3. VF-101 Communication monitoring group parameters

Table 3.3 VF-101 Communication monitoring table

Parameter code (address)	Name	Instruction	R/W
0x3102	Inverter status	Bit0 0:shutdown state, 1:Operating status	R
		Bit1 0:non-accelerated theme, 1:Accelerated state	
		Bit2 0:non-decelerating state, 1:deceleration state	
		Bit3 0:positive, 1:reverse	
		Bit4 0:no fault, 1:Inverter fault	
		Bit5 0:GPRS non-locking machine, 1:GPRS lock	
		Bit6 0:no warning, 1:Inverter warning	
		Bit7 0: no-ready, 1: ready	
		Bit8 0: Communication with the control board is not faulty 1: Communication failure with the control board	
0x3110	Reserve	-	R
0x3118	Reserve	-	R
0x3119	Reserve	-	R
0x311A	Reserve	-	R
C00.00(0x2100)	Given frequency	0.01Hz	R
C00.01 (0x2101)	Output frequency	0.01Hz	R
C00.02 (0x2102)	Output current	0.1A	R
C00.03 (0x2103)	Input voltage	0.1V	R
C00.04 (0x2104)	The output voltage	0.1V	R
C00.05 (0x2105)	Mechanical speed	1rpm	R
C00.06 (0x2106)	Given torque	0.1%	R
C00.07 (0x2107)	Output torque	0.1%	R
C00.08 (0x2108)	PID given amount	0.1%	R
C00.09 (0x2109)	PID feedback amount	0.1%	R
C00.10 (0x210A)	Output Power	0.1%	R
C00.11 (0x210B)	Bus voltage	0.1V	R
C00.12 (0x210C)	Module temperature 1	0.1°C	R
C00.13 (0x210D)	Module temperature 2	0.1°C	R
C00.14 (0x210E)	Input terminal X on state	-	R
C00.15 (0x210F)	Output terminal Y on state	-	R
C00.16 (0x2110)	Analog AI1 input value	0.001V/0.001mA	R
C00.17 (0x2111)	Analog AI2 input value	0.001V/0.001mA	R
C00.18 (0x2112)	Reserve	-	R
C00.19 (0x2113)	Pulse signal PUL input value	0.001kHz	R
C00.20 (0x2114)	Analog output AO1	0.01V/0.01mA/0.01kHz	R
C00.21 (0x2115)	Analog output AO2	0.01V/0.01mA/0.01kHz	R
C00.22 (0x2116)	counter count value	1	R
C00.23 (0x2117)	The running time of this power-on	0.1Hour	R
C00.24 (0x2118)	The cumulative running time of the machine	Hour	R
C00.25 (0x2119)	Inverter power class	0.1kW	R
C00.26 (0x211A)	Inverter rated voltage	V	R
C00.27 (0x211B)	Inverter rated current	0.1A	R
C00.28 (0x211C)	Software version	-	R
C00.29 (0x211D)	PG feedback frequency	0.01Hz	R
C00.30 (0x211E)	Timer time	seconds/minutes/hours	R
C00.31 (0x211F)	PID output value	0.01%	R
C00.32 (0x2120)	Inverter software subversion	-	R
C00.33 (0x2121)	Encoder feedback angle	0.1°	R
C00.34 (0x2122)	Z pulse cumulative error	1	R
C00.35 (0x2123)	Z pulse count	1	R
C00.36 (0x2124)	Fault warning code	0~63fault number, 64~128warning number	R
C00.37 (0x2125)	Cumulative power consumption (low)	1°	R
C00.38 (0x2126)	Cumulative power consumption (high)	10000°	R
C00.39 (0x2127)	Power factor angle	0.1°	R

4. Communication Instructions

4.1. PDO data description

PDO realizes the periodic data exchange between the master station and the slave station. The PDO mapping object can add or reduce mapping parameters through the master station (the maximum number of mapping variables for TPDO and RPDO is 10 respectively). The default mapping of PDO mainly includes the following:

Inverter control command, target frequency given.

The current status and running frequency of the inverter can be read in real time.

4.2. Mailbox data SDO

Mailbox data SDO is used to transmit non periodic data, such as the configuration of communication parameters, the configuration of inverter operation parameters, etc. Types of CoE services include:

1. Emergency
2. SDO request
3. SDO response
4. TPDO
5. RPDO
6. SDO information, etc.

5. Operation example

5.1 Controlling VF-101 inverter with Beckhoff controller

The following describes how to use the EtherCAT communication card via TwinCAT3 simple configuration.

Note: Regarding the network card, please choose to use Intel Chip 100M Ethernet card.

1. **Install TwinCAT3**
2. **Add xml file**

Copy the xml configuration file (VF101_ECCT1_TO_00010_00000_M_20221220.xml) of VF101ECCT1 to the following directory:

TwinCAT3 directory: TwinCAT\3.1\Config\Io\EtherCAT.

3. **New project**

- a. Open TwinCAT3, open the new project box through the path "File->New->Project", and click OK to create a new TwinCAT project.

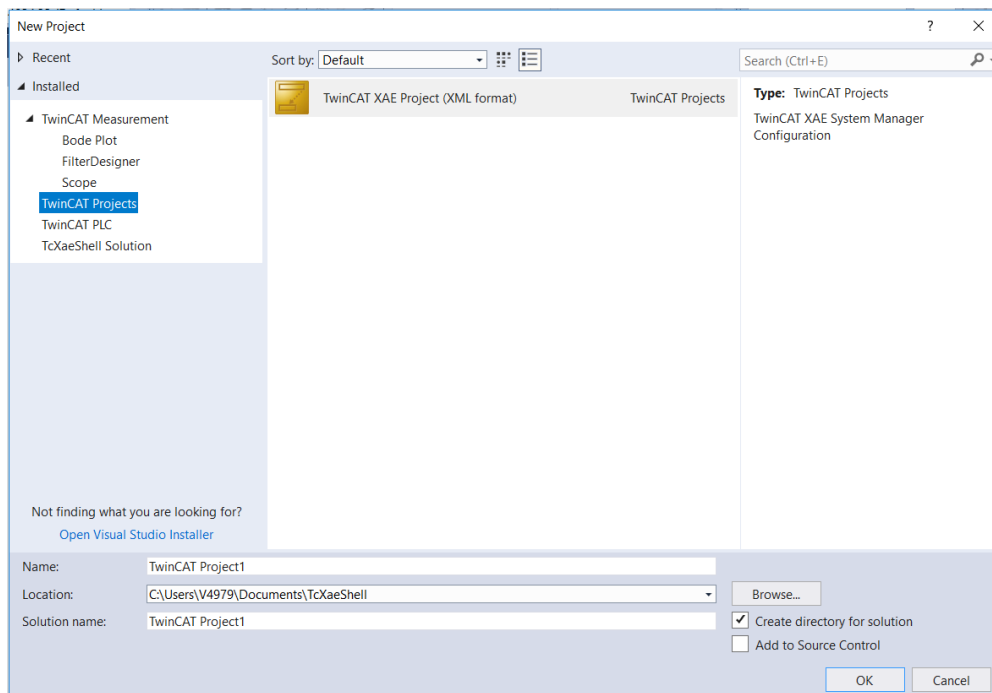

- b. Install the TwinCAT network card driver: Click the drop-down menu "Show Real Time Ethernet Compatible Devices...", the following dialog box will pop up, select the local website in the "Incompatible devices" column, click Install, after completion, it will be displayed in "Installed and ready to use devices" "The installed network card appears in the column.

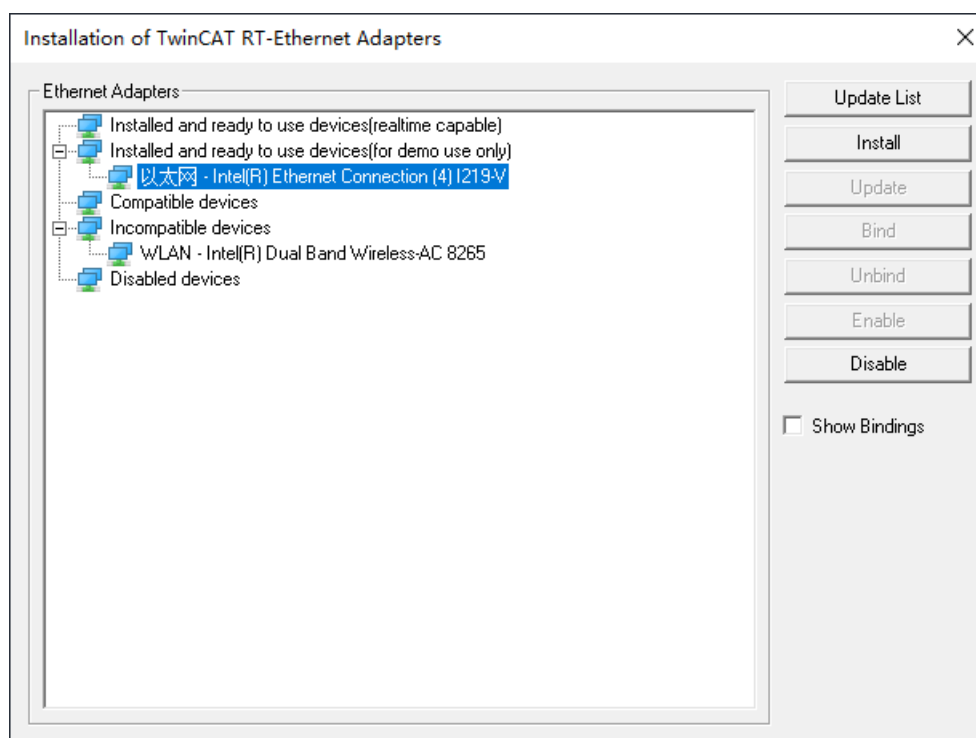
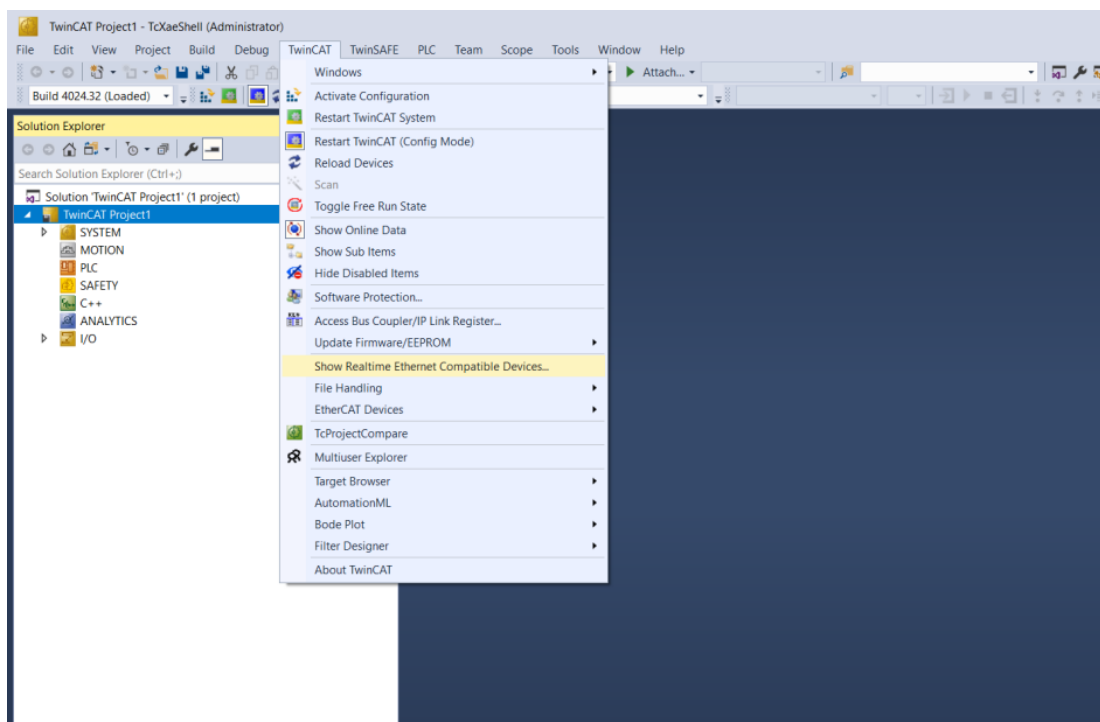

- c. Search device: Right click Devices in the I/O drop-down box on the left column, and select scan. After confirmation, wait for a moment to pop up the "Device has been found" window. Follow the figure below for a series of confirmation operations. Finally, you can judge whether the device has successfully established a connection with the master station through the state status in the Online tab

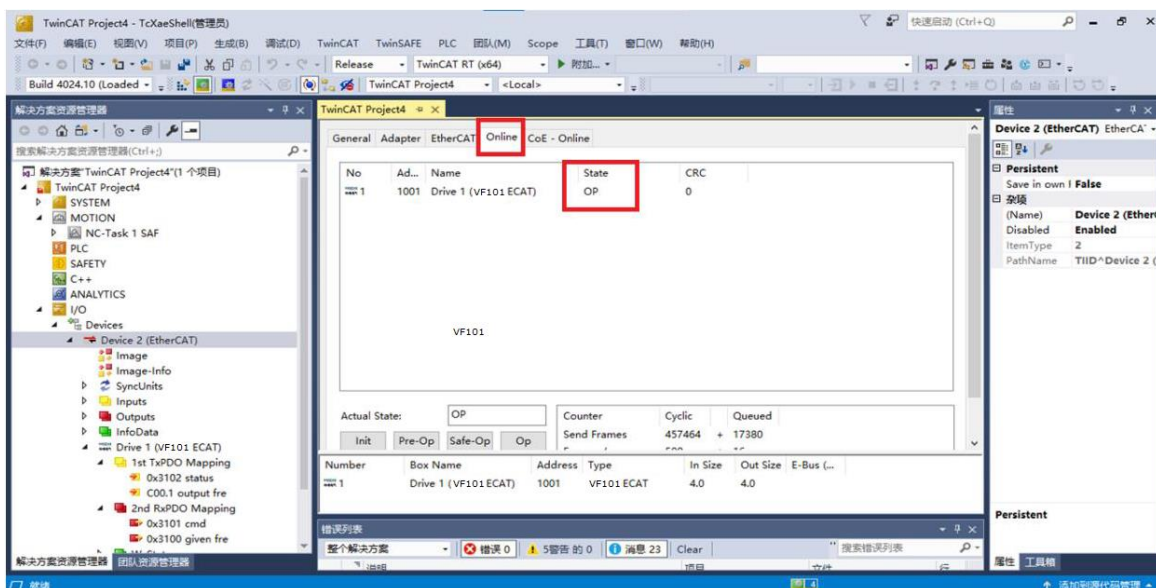
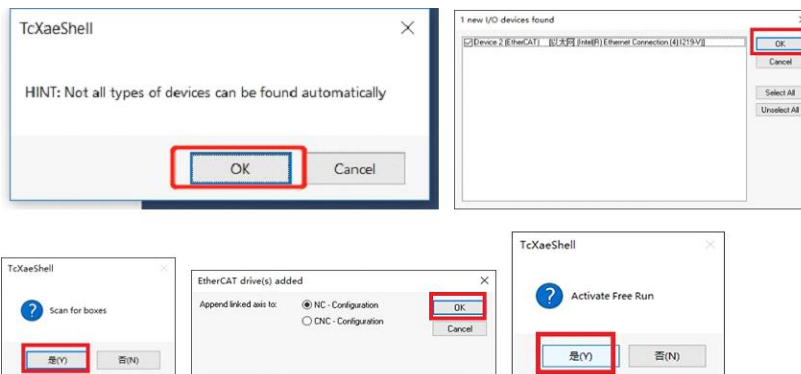
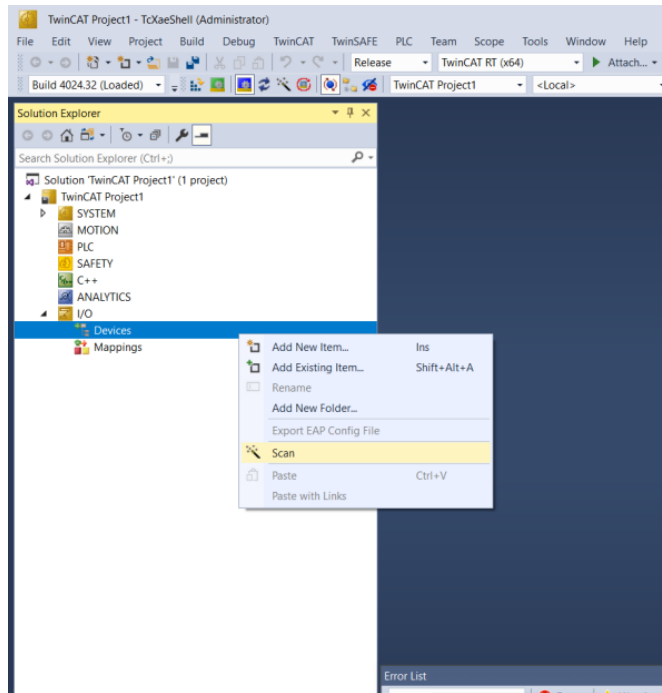

4. SDO data list

After entering the OP state, the user can observe the data through the SDO data list, or modify the SDO data by double-clicking the object dictionary.

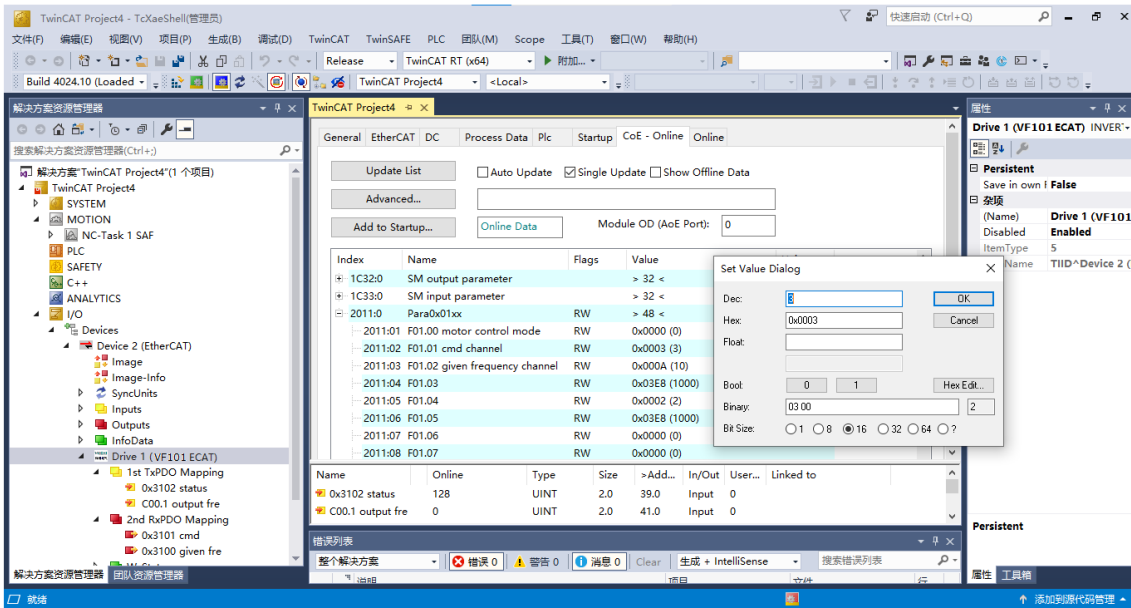

5. Configure PDO parameters

- a. Configure RPDO: The extension card can choose 4 RPDO channels, numbered 0x1600x1603, each channel can support up to 10 RPDO mappings, the user can add the required mappings according to the needs; the first two mappings of each channel have default configuration, which can be reconfigured by the user.

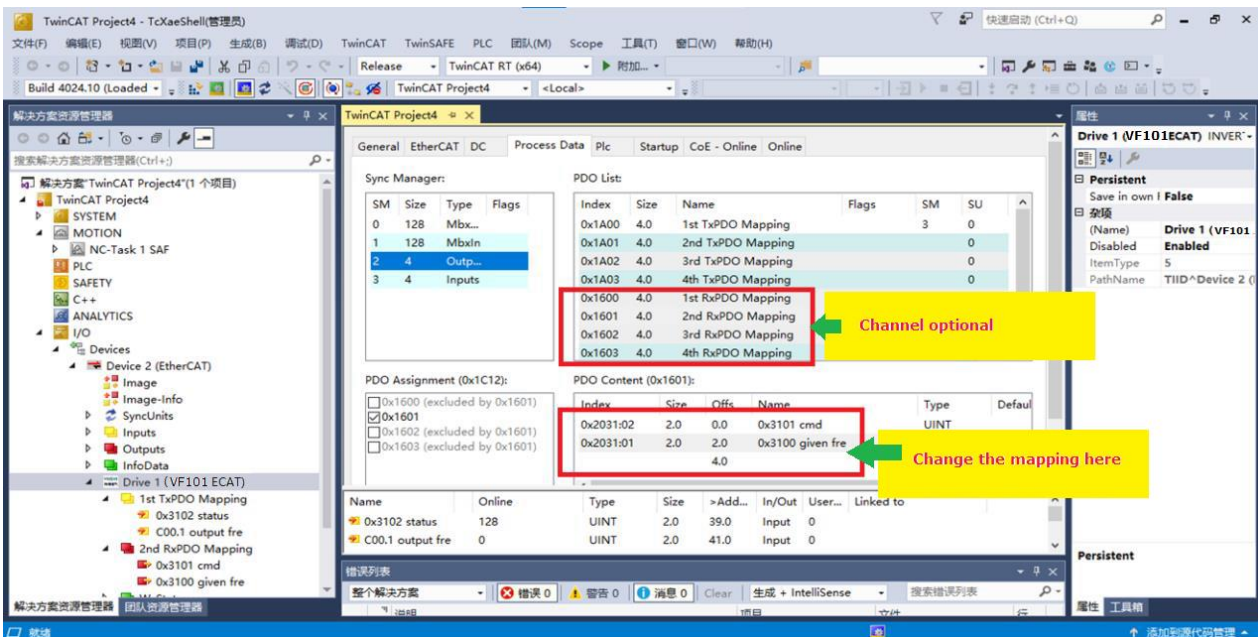

- b. Configure TPDO: The extension card can choose 4 TPDO channels, numbered 0x1A00x1A03, each channel can support up to 10 RPDO mappings, the user can add the required mappings according to the needs; the first two mappings of each channel have default configuration, which can be reconfigured by the user.

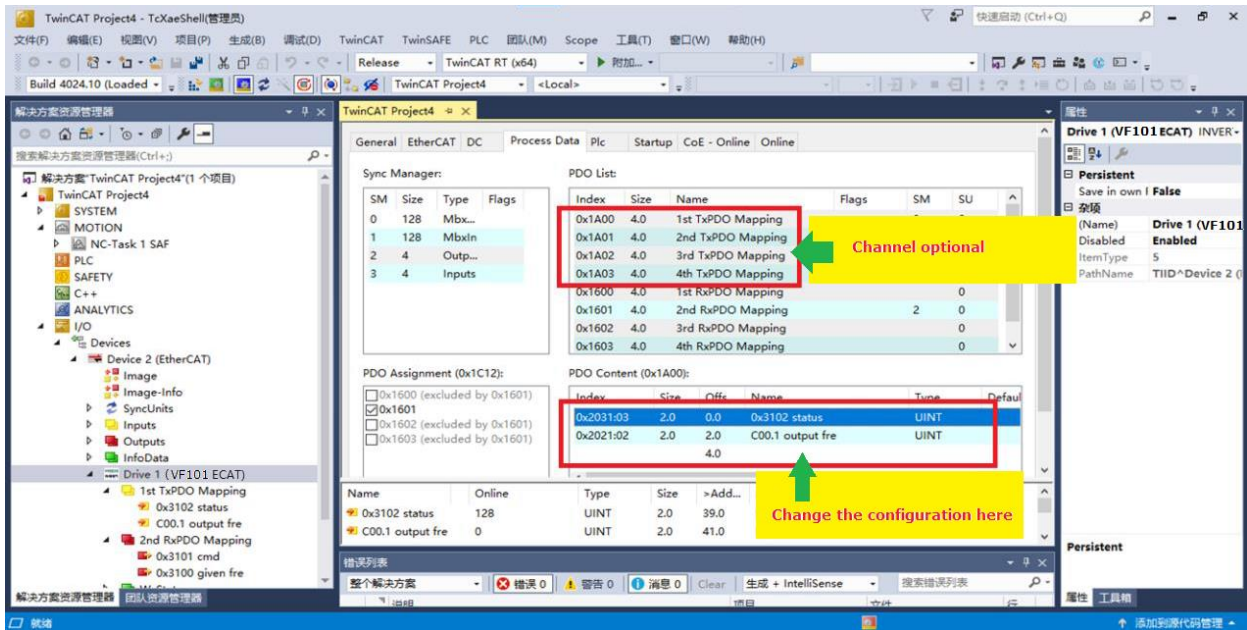

6. Reactivate the configuration and switch to run mode

After each change of the PDO mapping, the user needs to reactivate the configuration for the new configuration to take effect.

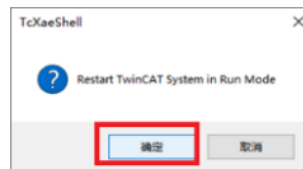
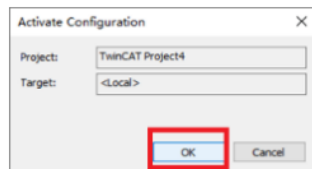
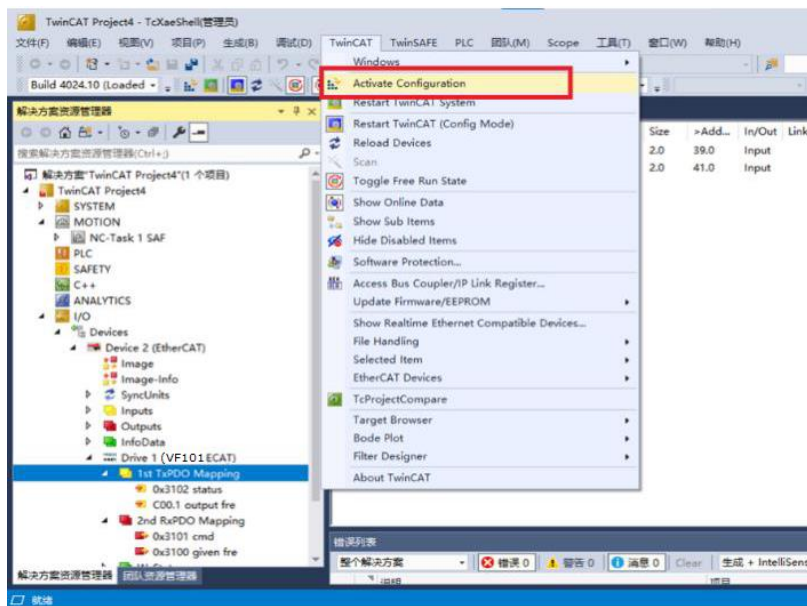

7. Control the inverter through PDO

Set the value of the corresponding PDO map to control the operation of the frequency inverter.

Note: The given source of some function codes needs to be set to TwinCAT first to be valid when the function code is changed in TwinCAT;

For example, for the function code 0x3101 cmd, it is necessary to set the function code F01.01 to 3 (the given source is set to an optional card), and then change the value of 0x3101 cmd in TwinCAT, so that the inverter can be controlled.

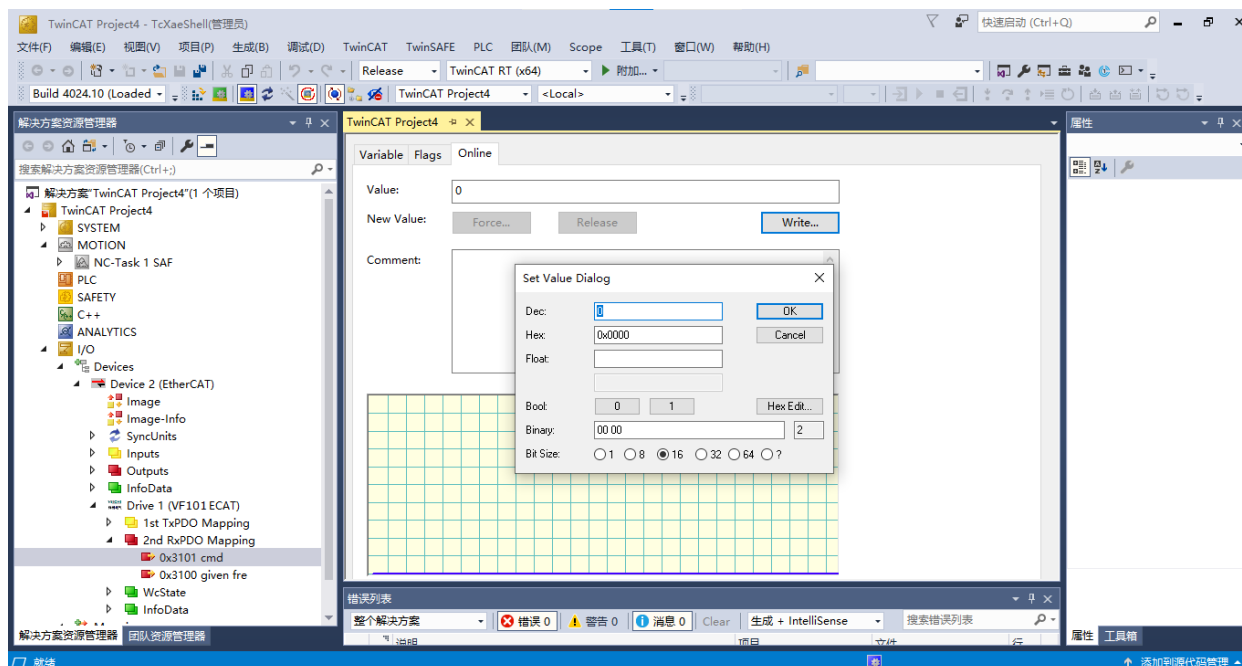

5.2 Use OMRON controller to control VF101 inverter

The following introduces the operation steps of running the VF101 inverter through the simple configuration of OMRON's NJ501-1300 master station.

1. Install Sysmac Studio
2. Configure the master IP address



3. New project

When creating a project, select the correct device model.

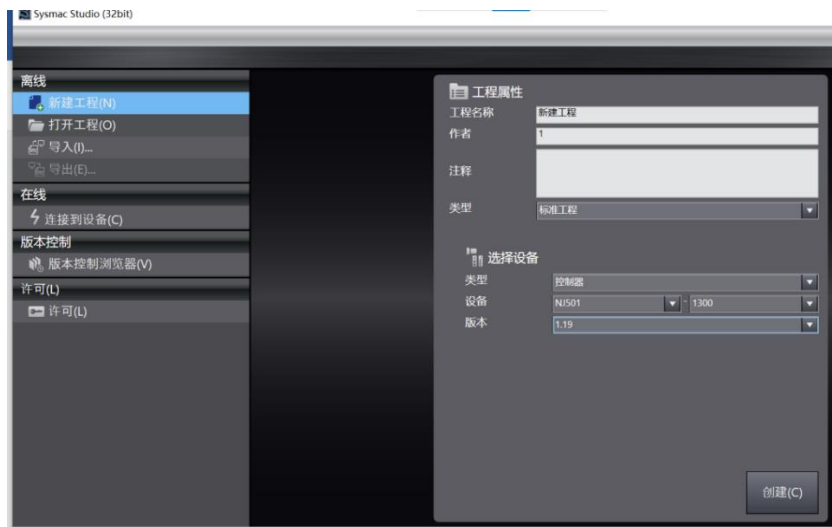

4. Communication configuration

- a. After entering the main interface, open the communication settings dialog box through the path "Controller->Communication Settings", select "Ethernet-Hub Connection" for the connection type, and set the remote IP address to "192.168.250.1".

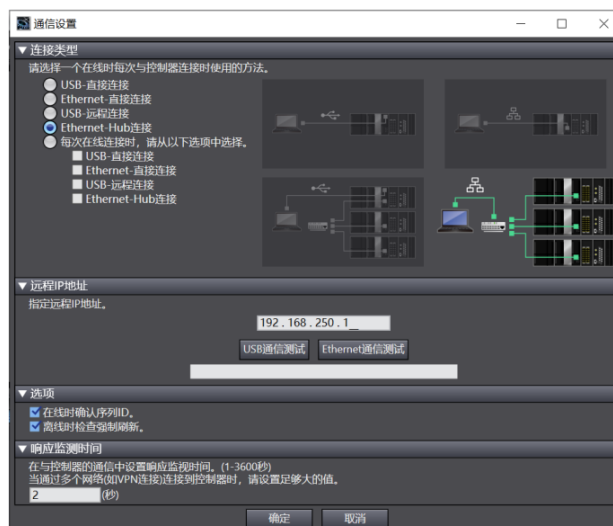

- b. Click "Ethernet Communication Test", if the test is successful, you can go to the next step.

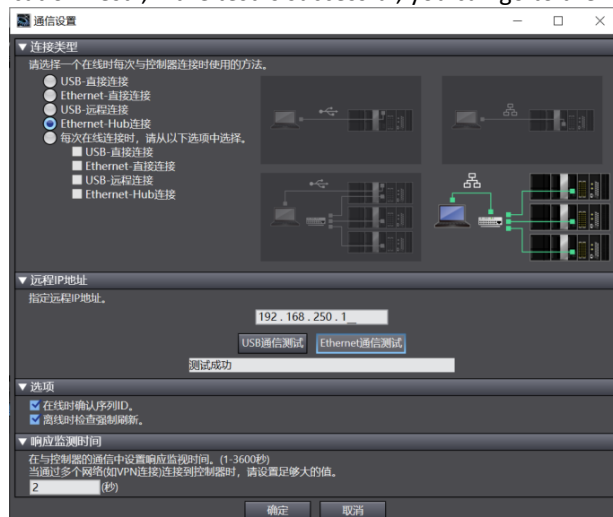

c. Import the xml configuration file

Double-click "EtherCAT" in the "Configuration and Settings" drop-down box in the left column, then right-click "Main Device" in the middle column, click "Show ESI Library", click "Installation File", find the path where the user-specified xml file is located and Open, click OK and the xml can be installed successfully.

This document takes importing the VF101_ECATA1_T0_00010_00000_M_20221220.xml file as an example. After the import is successful, the xml file name will be displayed in the Omron software directory.

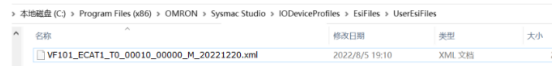
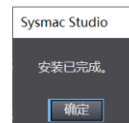
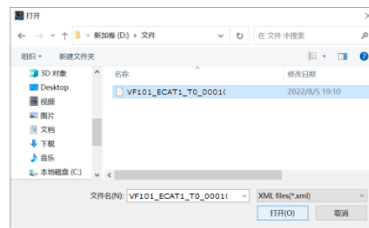
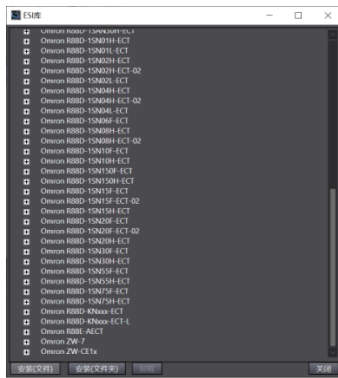
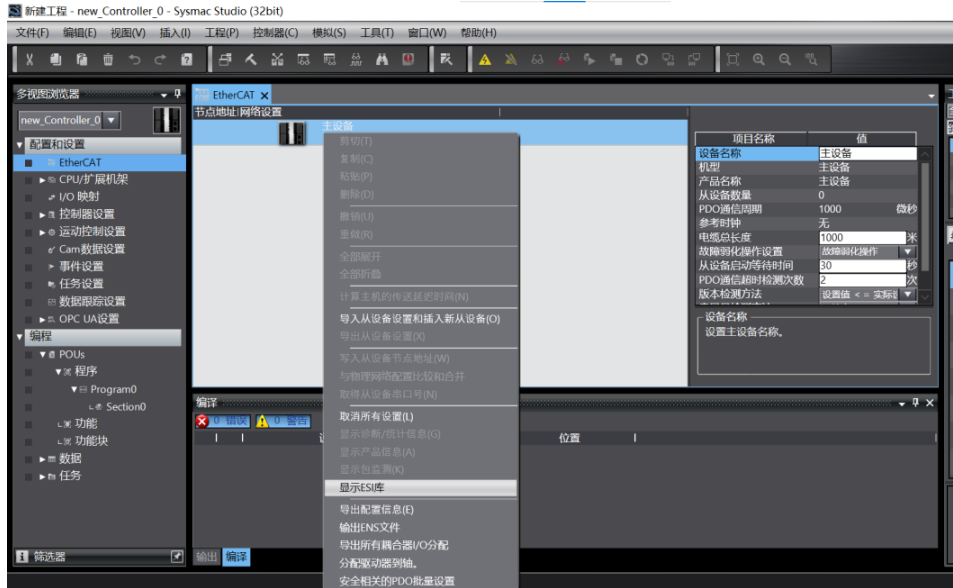

5. Scan the device

Click "Online", then click "Compare and Merge with Physical Network Configuration", select "Apply" and close it. At this time, it can be observed from the lower right corner that the controller status is online.

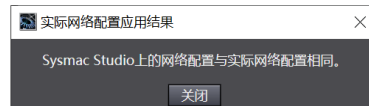
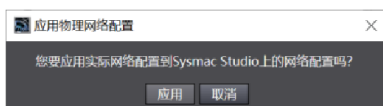
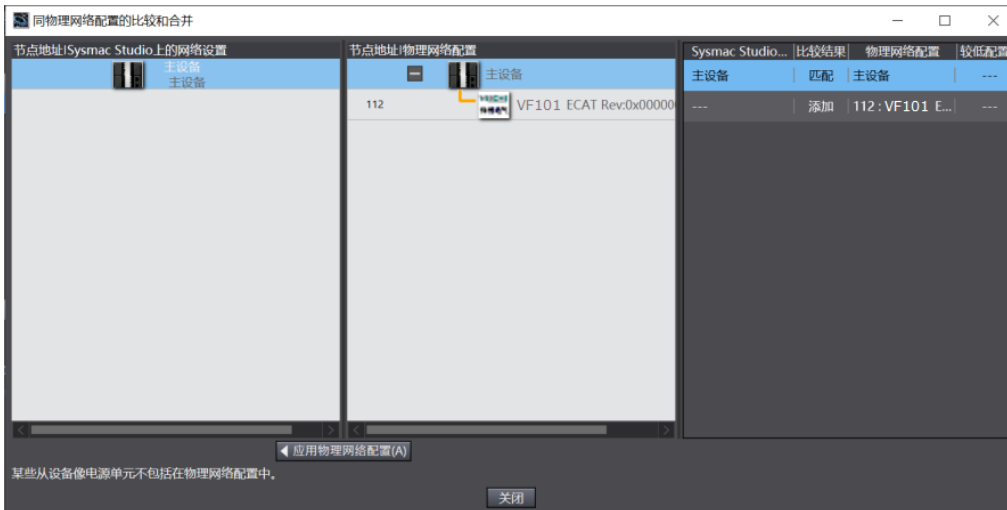
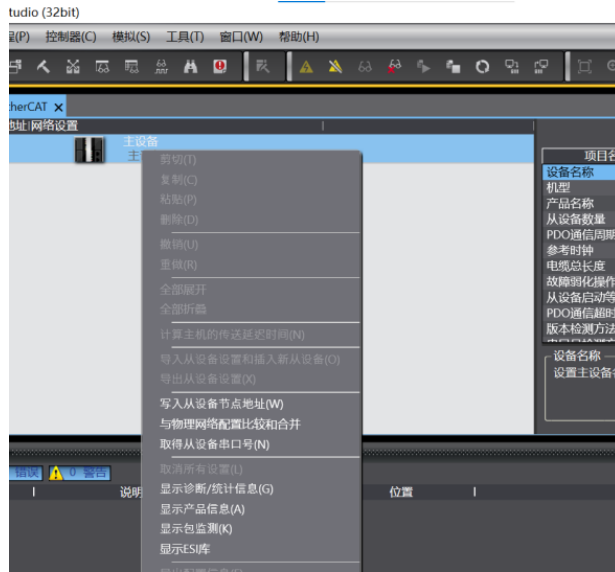

6. Parameter configuration

Click "Offline" to open the I/O mapping on the left column, and you can see the mapping variables configured by default in the system. Users can set relevant variables according to their needs.

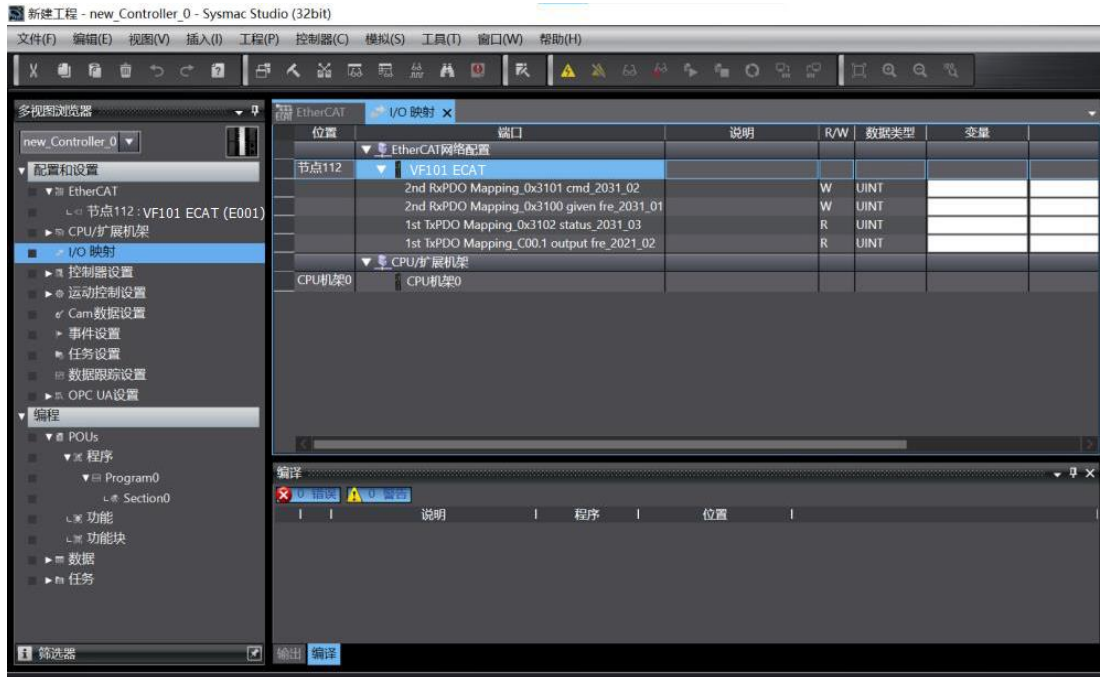

7. Edit PLC program

- a. Define and add variables: You can set the variable name of the PDO mapping, and add new variables.

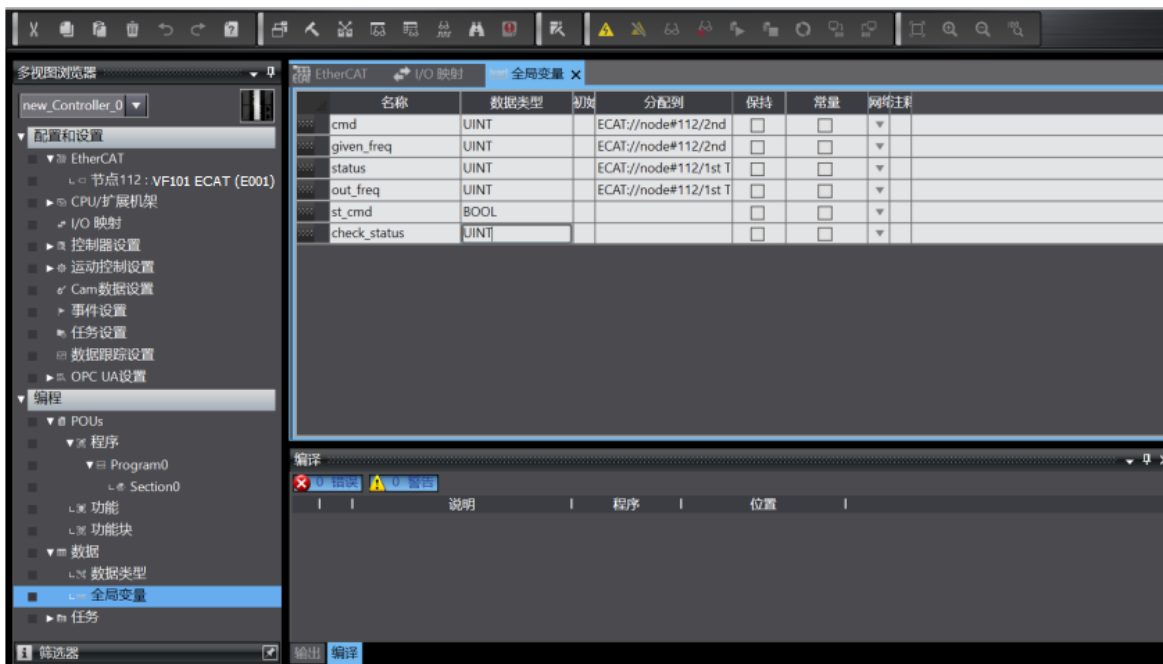
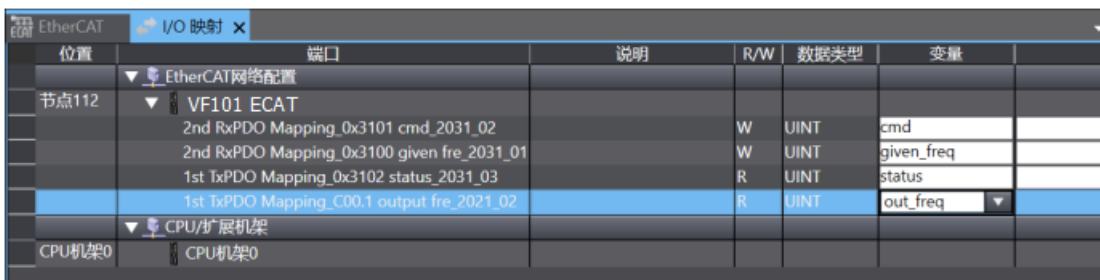

b. Write PLC program.

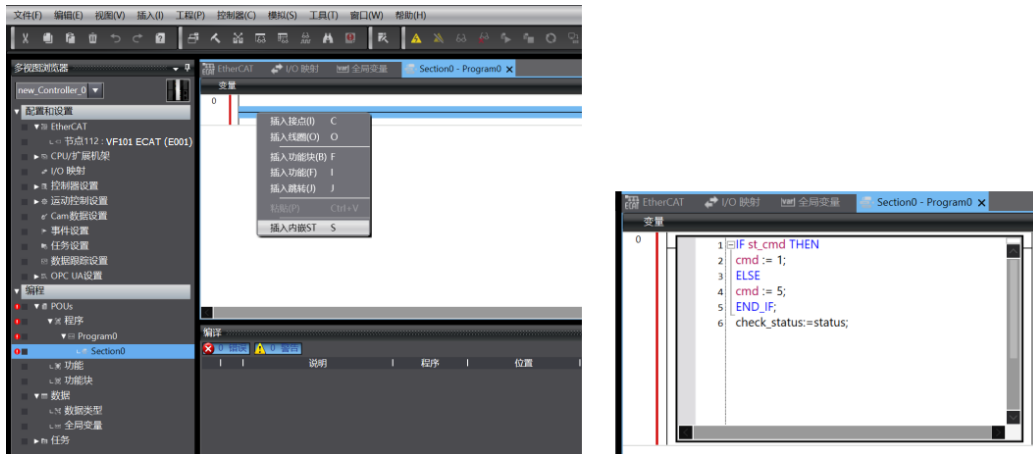

c. Add the program to the main task through the "Task Settings" window.

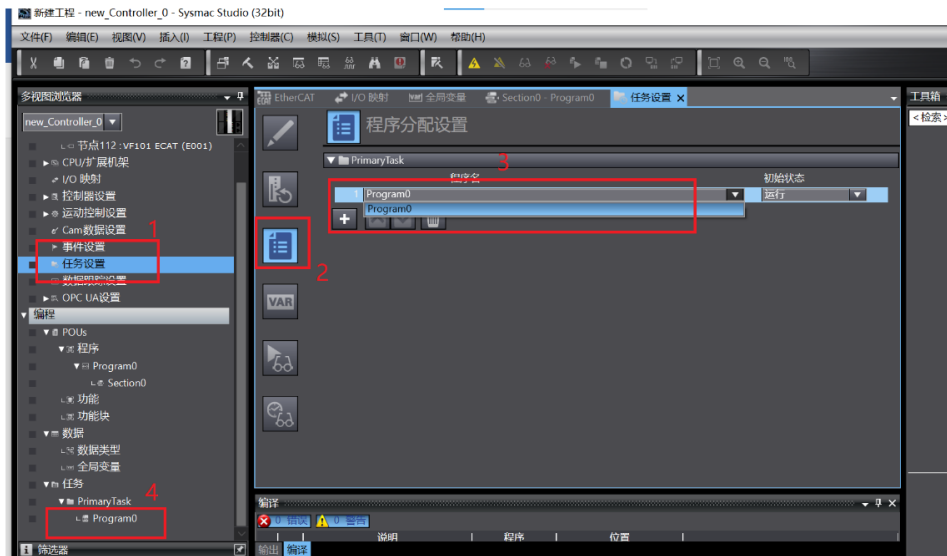

8. Download to the controller: After running online, click "to the controller" to observe the execution of the program in real time.

