

VEDA HCT User Manual

Content

1 Introduction	1
2 Quick start	1
2.1 Electrical connection of the screen	1
2.1.1 Connect to the power supply	1
2.1.2 Connect to the computer	1
2.1.3 Serial port connection	1
2.1.4 USB Host connection	2
2.1.5 Network port using	2
2.2 Software downloading and installing	2
2.2.1 Software downloading	2
2.2.2 Software installing	2
2.2.3 Installation is completed.	3
2.3 First use	4
2.4 Project download and upload	8
2.4.1 Project downloading	8
2.4.2 Project downloading from USB disk	10
2.4.3 Project uploading	14
2.4.4 Project uploading to USB disk.	17
2.4.5 Project decompiling	17
3 Description for communication connection	19
DELTA	19
FATEK	20
Flexem	21
1 flexem_fl2n_mistubishi_fx2n_compatible	21
2 flexem_fl2n_modbus	22
3 Differences between Flexem FL2N(Mistubishi FX2N Compatible) and Flexem FL2N(Modbus)	22
HCFA	23
Hitachi	25
HollySys	26
Inovance	27
Kewei	28
KEYENCE	29
Kinco	29
LS	30
1 ls_mster_cpu_serial	30
2 ls_xgt_cpu_serial	31
MEGMEET	32
MIKOM	33
Mitsubishi	34
1 Mitsubishi_FX0S_FX0N_FX1S_FX1N_FX2	34
2 Mitsubishi FX2N	35

VEDA HCT User Manual

3 Mitsubishi FX3U_FX3G	36
4 Mitsubishi Melsec Q.....	37
5 Mitsubishi_FX3U_ENET_L	38
6 Mitsubishi_melsec_ethernet	39
Modbus	40
1 Modbus_RTU.....	41
2 Modbus_RTU_Extend.....	41
3 Differences between Modbus_RTU and Modbus_RTU_Extend.....	42
4 Modbus_TCP	42
5 Modbus_UDP	43
Modbus RTU Server - Serial port service	44
Modbus TCP Server– Ethernet service.....	45
OMRON	46
Panasonic	47
Siemens.....	49
1 Siemens S7_200	49
2 Siemens S7_200 Network.....	50
3 Siemens S7_200 Network Module	51
4 Siemens S7_300 MPI.....	52
5 Siemens S7_300_network.....	53
6 Siemens S7_1200_network	54
THINGET	56
TRIO.....	56
1 TRIO_modbus.....	56
2 TRIO_modbus_extend.....	57
3 Differences between TRIO_modbus and TRIO_modbus_extend.....	58
Yaskawa	58
1 Yaskawa	58
2 Yaskawa network device	58
Yokogawa.....	59
4 Detailed manual	61
4.1 File	61
4.2 View.....	62
4.3 Edit	64
4.4 Window	66
4.5 Drawing	70
4.5.1 Straight Line.....	70
4.5.2 Fold Line	71
4.5.3 Rectangle.....	72
4.5.4 Polygon.....	73
4.5.5 Ellipse	76
4.5.6 Arc	79
4.5.7 Sector	80
4.5.8 Sector Ring	81

VEDA HCT User Manual

4.5.9 Static Picture	82
4.5.10 Static Text	88
4.6 Component.....	94
4.6.1 Switch	94
4.6.2 Indicator Light	114
4.6.3 Numeric Value and Character Display	121
4.6.4 Toggle Switch and menu.....	143
4.6.5 Timer and Data Transmission	166
4.6.6 Barand Meter	176
4.6.7Curve Graphs.....	188
4.6.8 Scale	208
4.6.9 Table	215
4.6.10 Slider	221
4.6.11 Moving Component.....	224
4.6.12 Window	226
4.6.13 List	234
4.6.14 Tools	257
4.6.15 Pipeline.....	262
4.7Library	266
4.7.1GraphicsLibrary	266
4.7.2Text Library.....	271
4.7.3Address Tag Library	275
4.7.4 Audio Library.....	277
4.8Macro	285
4.8.1Create Macro.....	285
4.8.2Edit Macro	286
4.8.3 Enable Password Verification	287
4.8.4 Update Macro Password	288
4.9 Recipe.....	290
4.9.1General.....	290
4.9.2 Data Information	294
4.10 Setup	297
4.10.1 HMI settings	297
4.10.2 System Settings	300
4.10.3Communication Settings	346
4.10.4 Options.....	364
4.11 Tools	367
4.12 Help	370
4.13 General functions.....	371
4.13.1 Address editor	371
4.13.2 Drawing	380
4.13.3Font settings.....	382
4.13.4 Graphic edit.....	384
4.13.5 Control settings	388

VEDA HCT User Manual

4.13.6 Display	395
4.13.7 Keyboard setting	398
4.13.8 Label	401
4.13.9 Marquee	404
4.13.10 Logic Control.....	406
4.13.11 Shadow Effect.....	411
4.13.12 Position.....	412
4.13.13 Rotation	414
4.13.14 Dynamic Graphics.....	415
4.13.15 Table Drawing	416
4.13.16 Export CSV	418
5 Use topic	420
5.1 Find and Replace	420
5.2 Outline.....	421
5.4 Macro	424
5.4.1 Macro Editor Introduction.....	424
5.4.2 A Macro example	428
5.5 Online software upgrade.....	435
6 Appendix	436
6.1The Use of Register	436
6.1.1 Word Register	436
6.1.2 Bit Register	437
6.2 Built-in Functions	438
6.2.1 Read Write Function.....	438
6.2.2 System Functions.....	445
6.2.3 Computation and Conversion Function.....	450
6.2.4 Operator	450
6.3 System Register Bits and Words List.....	451

VEDA HCT User Manual

1 Introduction

The software “VEDA HCT” you are using is a new configuration software product developed by our R&D team for VEDA HMI. It was produced with more than ten years of technical experience and accumulation based on sufficient practices on Human Machine Interface product development and field actualization. We believe you will feel our specialization and concentration when you use this software. Thank you!

2 Quick start

2.1 Electrical connection of the screen

2.1.1 Connect to the power supply

The rated voltage of the screen is DC18~28V, and DC24V power supply is recommended. The interface is at the back, as shown in Fig. 1, the “24V+” is connected to “DC24V”, the “24V-” (or “0V”) is connected to “GND”. If the field is involved with a high interference, a highly reliable earth must be connected to the “FG” port. (Note: FG- Frame Ground, the reference grounding for the metal shell frame and the DC end.)

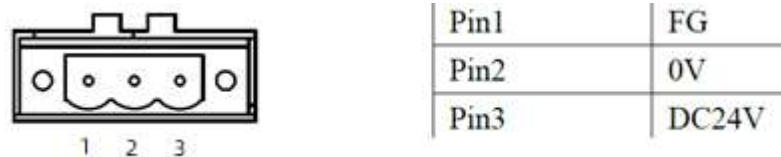

Fig. 1

2.1.2 Connect to the computer

The screen can be connected to the computer only via a USB data cable for project uploading and downloading, as shown in Fig. 2. The communication with computer can be realized when it is connected to the “USB SLAVE” end. The USB communication drive can be installed by the system in default during software installation, or the drive can be manually installed if it is damaged. The drive file is saved in the installation directory: “C:\ProgramFiles(x86)\VEDA HCT\VEDA HMI Configuration Tool 2.x\Driver”.



Fig. 2

2.1.3 Serial port connection

The serial port of the screen is a standard DB 9-pin port supporting communication modes RS232/485/422, as shown in Fig. 3. Different screen types are integrated with different quantities of serial ports, and please refer to the [Description for Communication Connection](#) for the detailed connecting method.

VEDA HCT User Manual

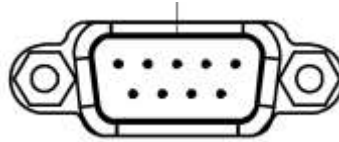

Fig. 3

2.1.4 USB Host connection

The screen is integrated with a USB Host device interface. This interface makes it easy to upload or download the project and the prescript by using the U disk. The sampling or warning data can also be saved in the U disk via this interface. A mouse or a keyboard with USB interface can be connected via the USB interface. A set of wireless mouse and keyboard is also usable. As shown in Fig. 4, a U disk can be directly inserted into the “USB HOST” port and be used.

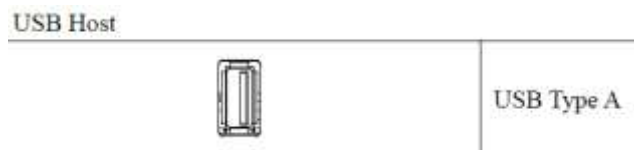

Fig. 4

2.1.5 Network port using

The standard RJ-45 network interface is used in the screen for communication with any down unit, as shown in Fig. 5. An RJ-45 plug can be directly inserted into the “Ethernet” port and used.

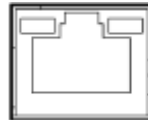

Fig. 5

2.2 Software downloading and installing

2.2.1 Software downloading

The software “VEDA HCT” can be downloaded from <https://drives.ru>. There are different versions according to the different operating systems (OS), as shown in Fig. 6.

Release Version			
File Name	Version	Date	Downloads
FStudio-2.8.11357.0	2.8.11357.0	2022-03-28	For Win7 SP1 Or Above For XP
FStudio-2.8.11315.0	2.8.11315.0	2022-03-07	For Win7 SP1 Or Above
FStudio-2.6.10986.0	2.6.10986.0	2021-07-14	For Win7 SP1 Or Above

Preview Version TEST			
File Name	Version	Date	Downloads

If you have Windows 7 SP1 or above, please click the "For Win7 SP1 Or Above" link instead., the installation time will be significantly reduced.

System Requirement:
Windows XP SP3
Windows Vista SP1
Windows 7

Fig. 6

2.2.2 Software installing

Double click the “SETUP.exe” to install the software “VEDA HCT”, as shown in Fig. 7. Click the left button to start installation.

VEDA HCT User Manual

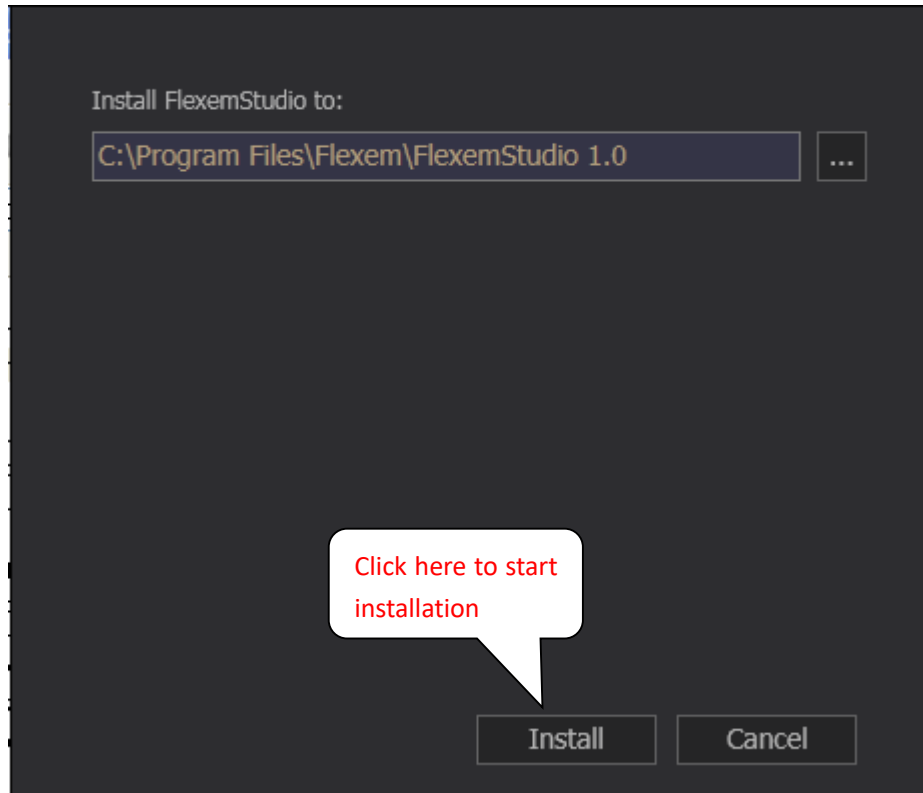
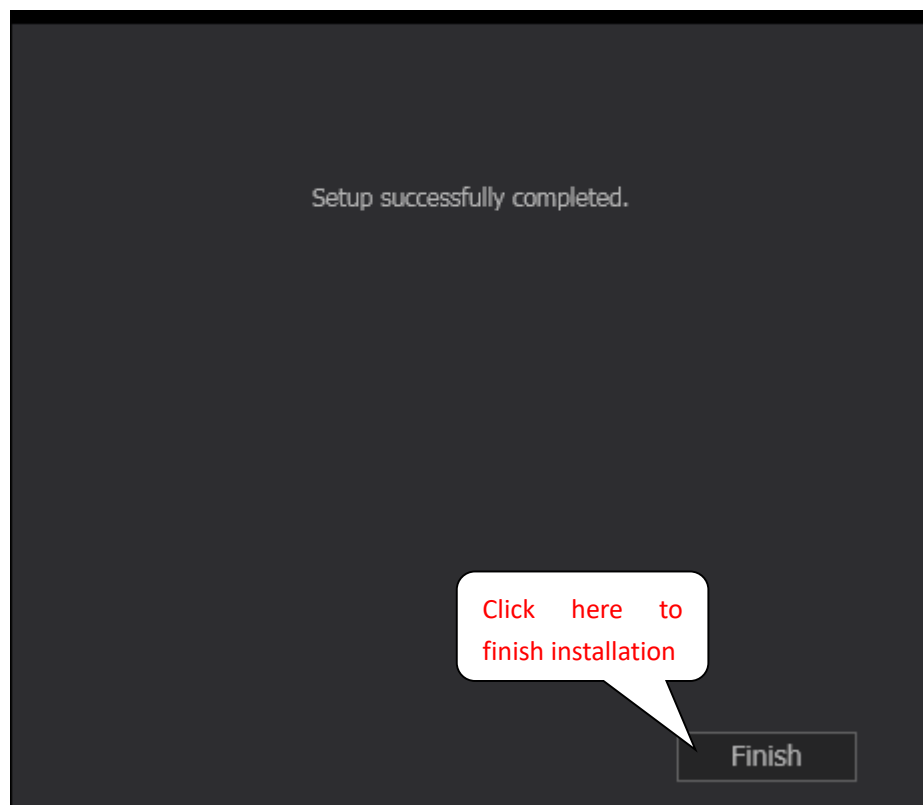

Fig. 7

2.2.3 Installation is completed.

Click the button to complete the software installation, as shown in Fig. 8.



VEDA HCT User Manual

Fig.8

2.3 First use

(1) Click the menu “File”–“New”, or click the shortcut “”, as shown in Fig. 9.

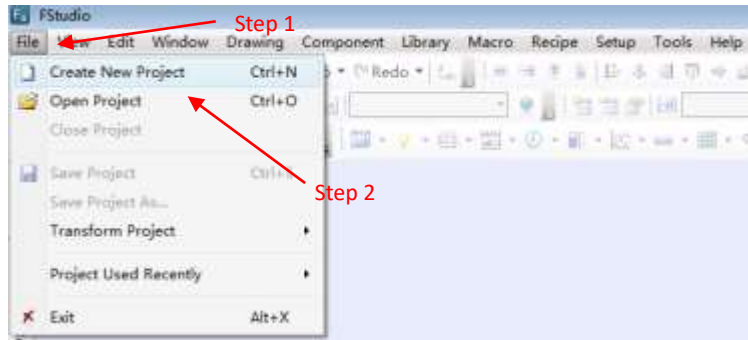

(a)

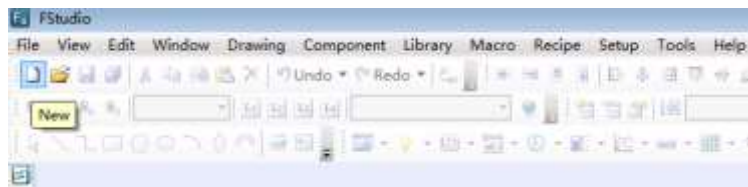

(b)

Fig. 9

(2) Enter the project name and select the project saving path. The project name can be Chinese, as shown in Fig. 10.

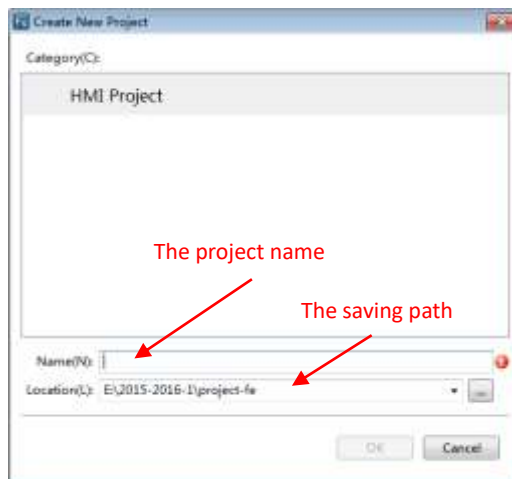

Fig. 10

(3) Select the touch screen type, as shown in Fig. 11.

VEDA HCT User Manual

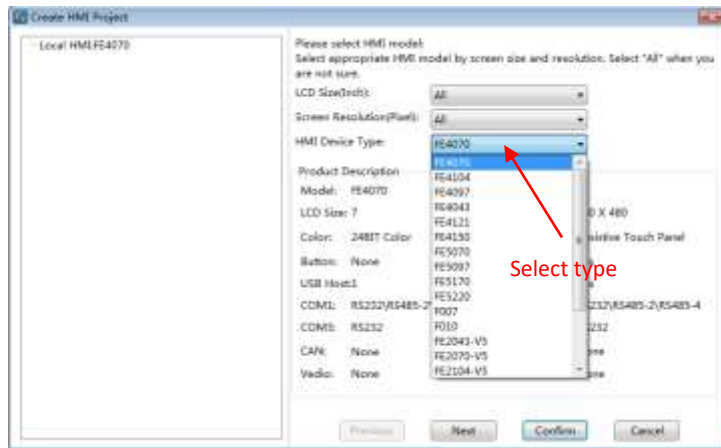
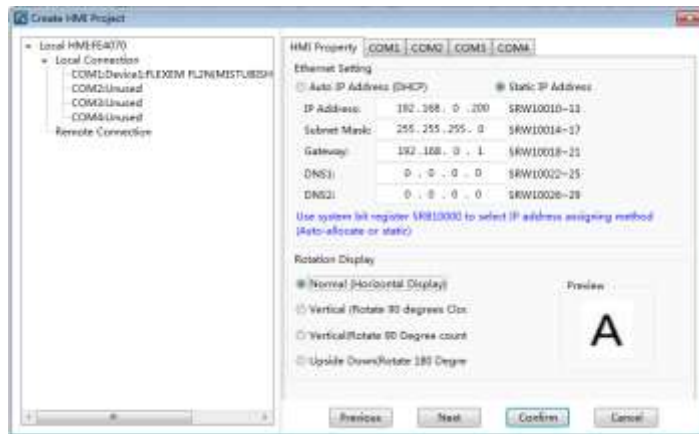
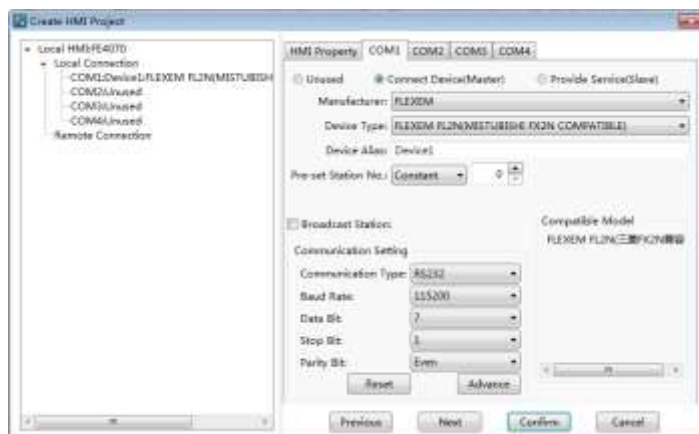

Fig. 11

(4) Click the button “Next” and set the bus line communication mode for the touch screen, as shown in Fig. 12.



(a) HMI Property



(b) COM

VEDA HCT User Manual

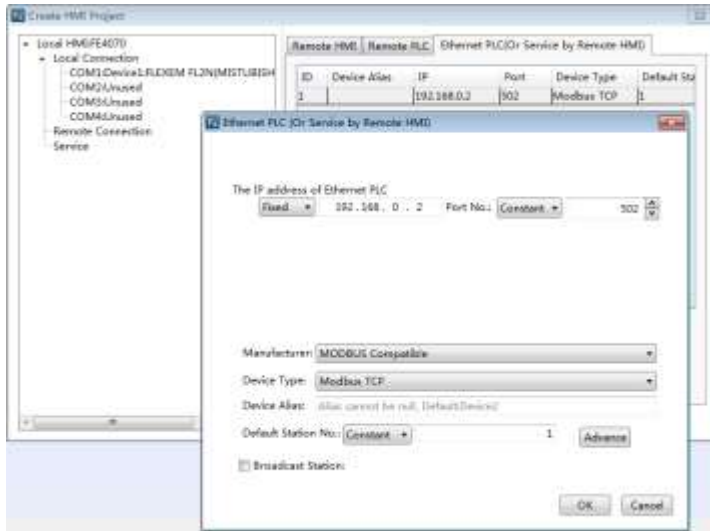

(c) Ethernet PLC (Or Service by Remote HMI)

Fig. 12

(5) After the project is initialized, click the button “Confirm” and the project is created, as shown in Fig. 13.



Fig. 13

(6) Add an “Input” variable and a “Display” variable into the picture and set the properties, as shown in Fig. 14.

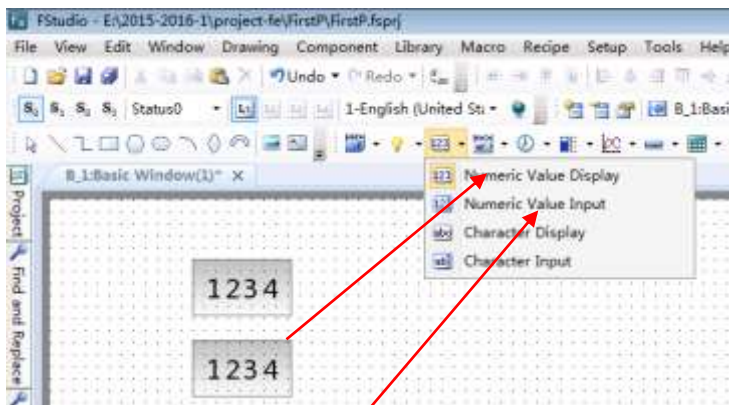

(a)

VEDA HCT User Manual

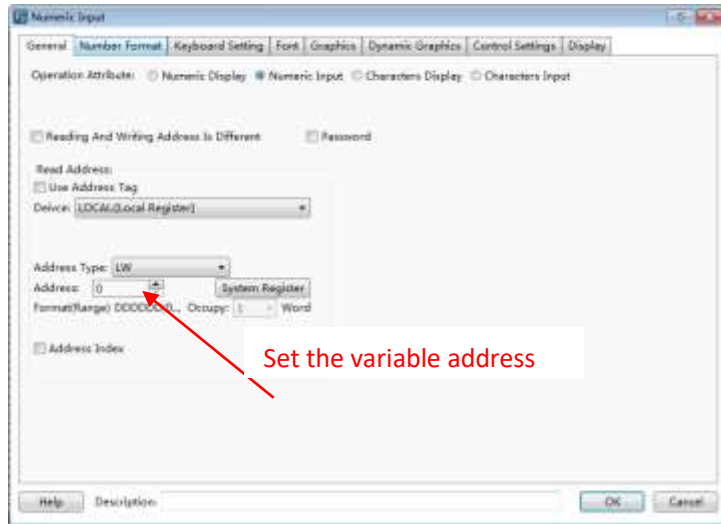

(b)

Fig. 14

(7) Click “Offline simulating” button and wait till engineering is completed, as shown in Fig. 15.

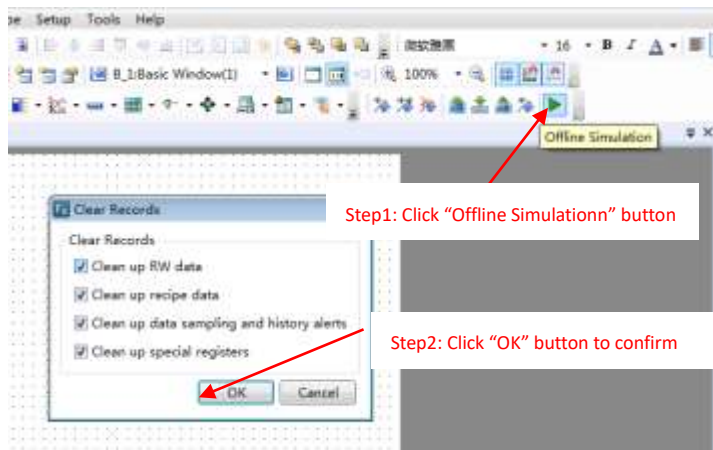
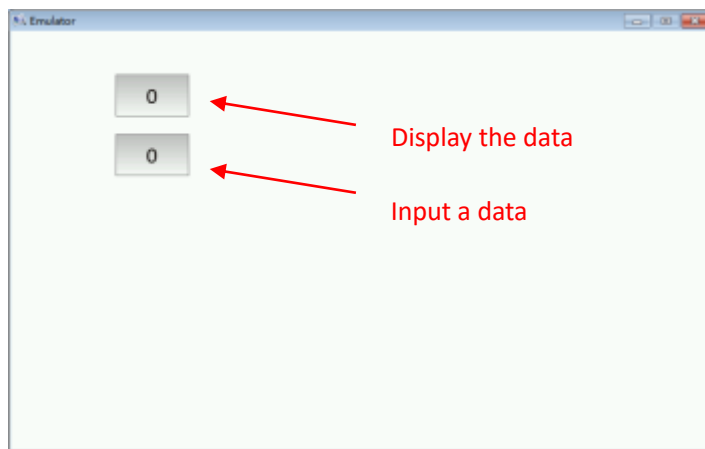

Fig. 15

(8) Debug with the simulator to view the design effect, as shown in Fig. 16.



(a)

VEDA HCT User Manual



(b)



(c)

Fig. 16

2.4 Project download and upload

2.4.1 Project downloading

① Switch on the power supply to the touch screen, select "Download" in the software, and wait till downloading is completed, as shown in Fig. 25.

VEDA HCT User Manual

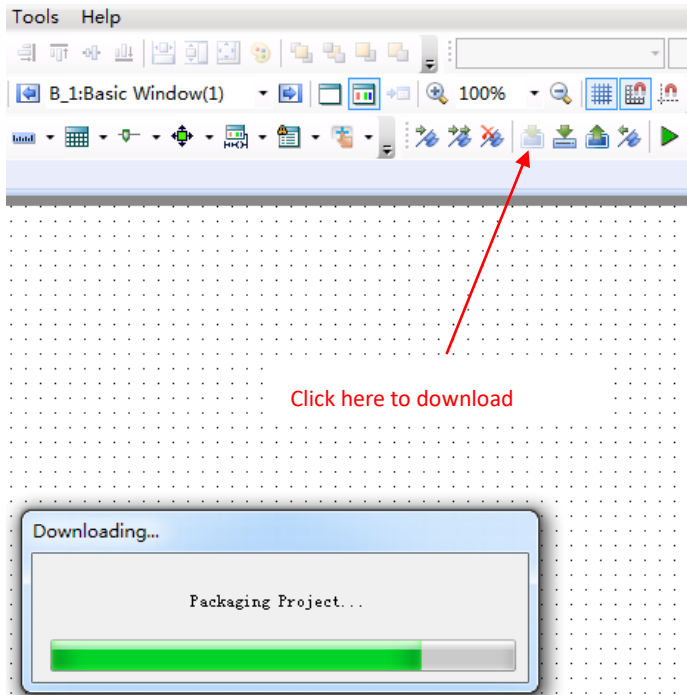

Fig. 25

② Select the project downloading mode, USB or network, and click OK to download, as shown in Fig. 26. If “Communication failure” appears, please check if the downloading line is correctly connected (USB line or network line). If the downloading operation is failed, please cut off the power supply to restart the HMI and try again.

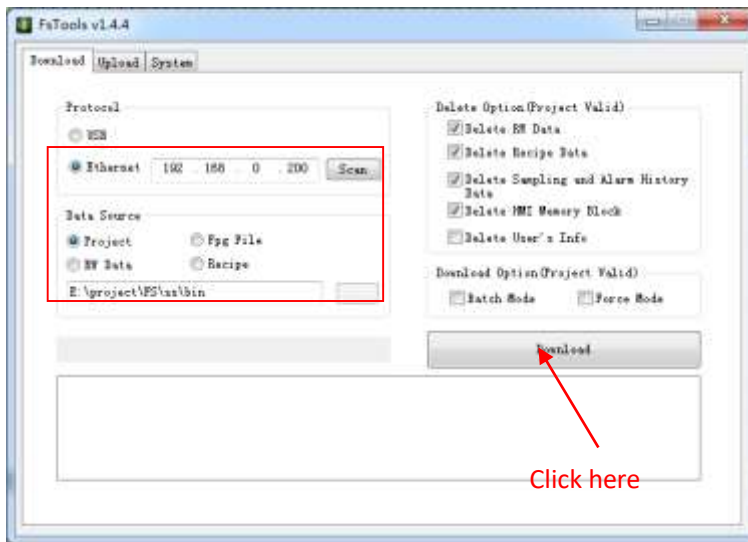
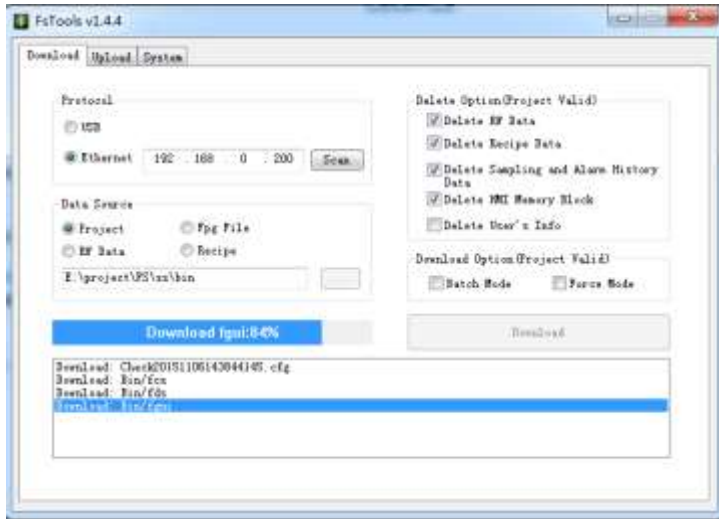

Fig. 26

③ Wait till downloading is completed, and then click “OK”, as shown in Fig. 27.

VEDA HCT User Manual



(a)

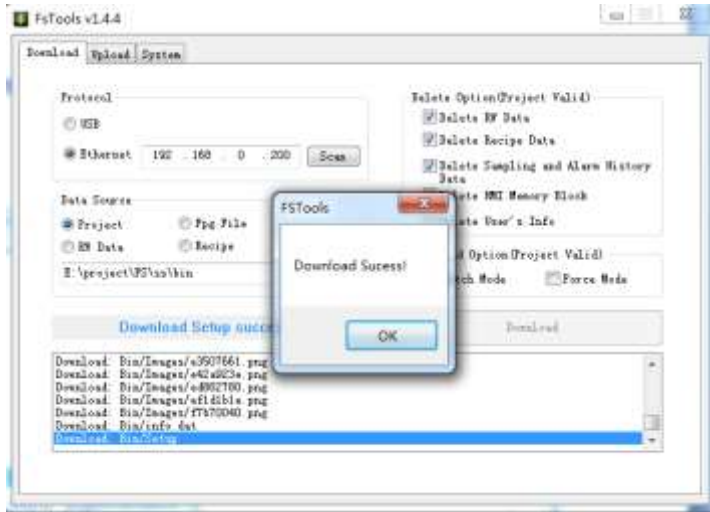

(b)

Fig. 27

2.4.2 Project downloading from USB disk

- ① Pack the project in the software and save it into the USB disk, as shown in Fig. 28.

VEDA HCT User Manual

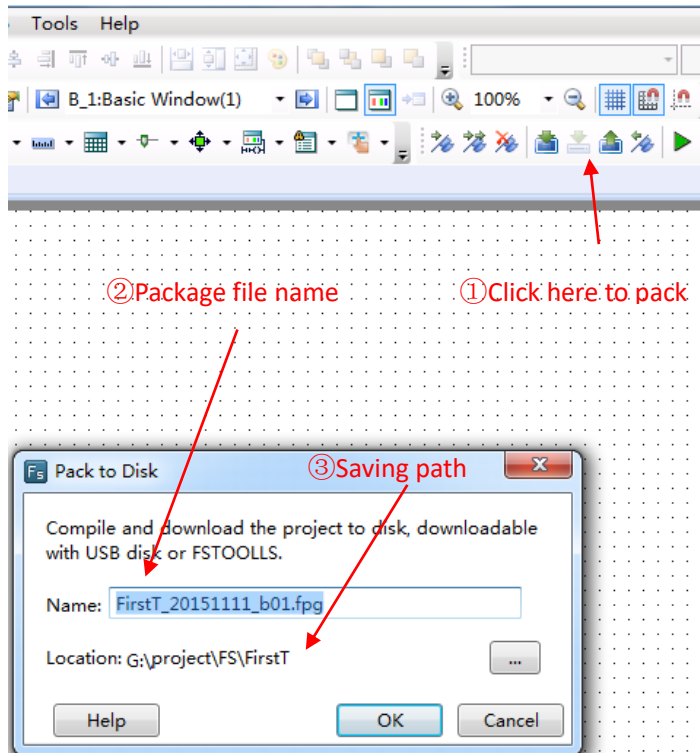

(a)

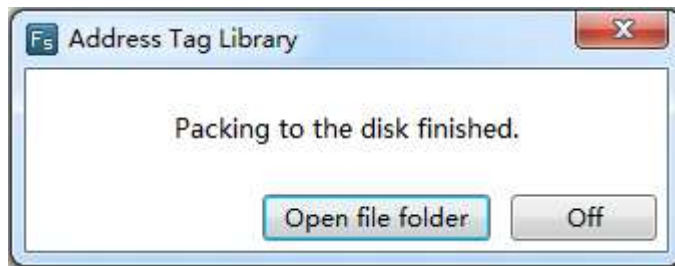

(b)

Fig. 28

② Insert the USB disk into the touch screen. When the touch screen is activated, press and hold at any point on the screen with a finger, as shown in Fig. 29.

VEDA HCT User Manual

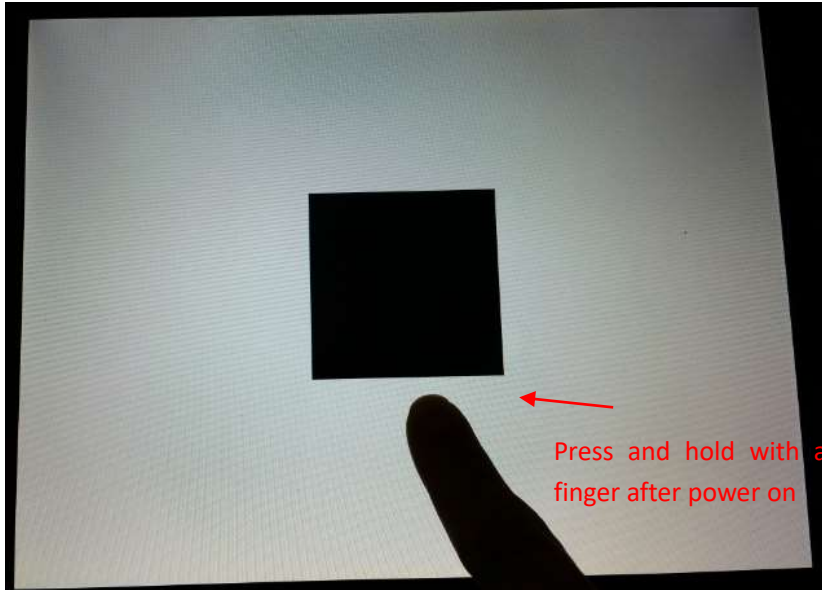

Fig. 29

③ Press the button "Setup" for uploading, as shown in Fig. 30. Select "Project" and enter the password, as shown in Fig. 31. The default password for project management is "888888" which can be modified in the "Global Setting" of the software.

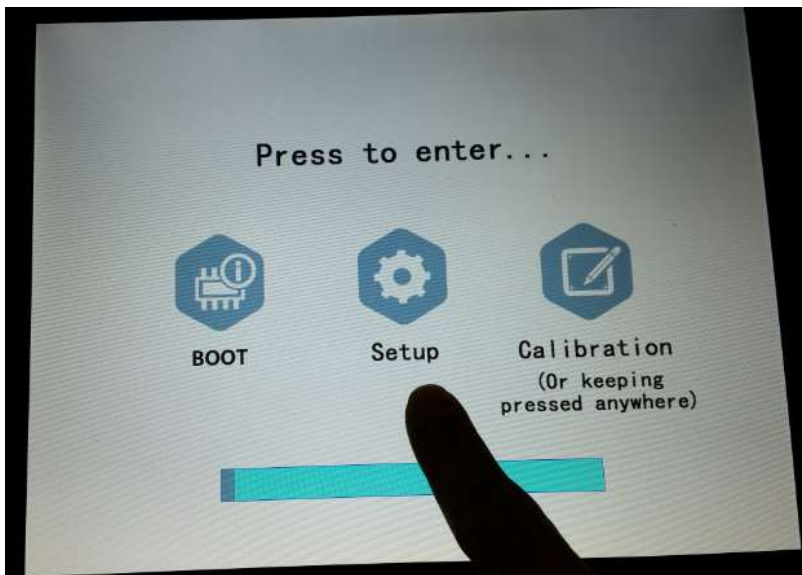

Fig. 30



VEDA HCT User Manual

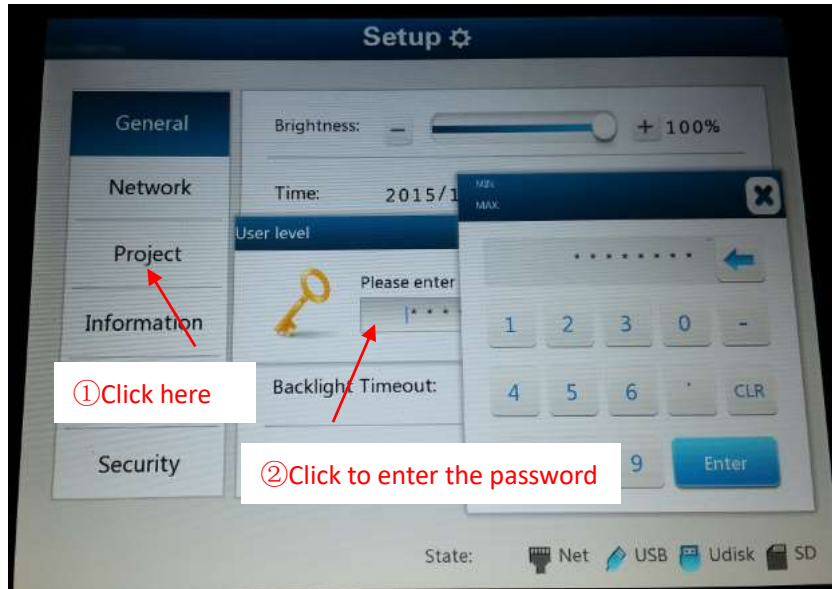
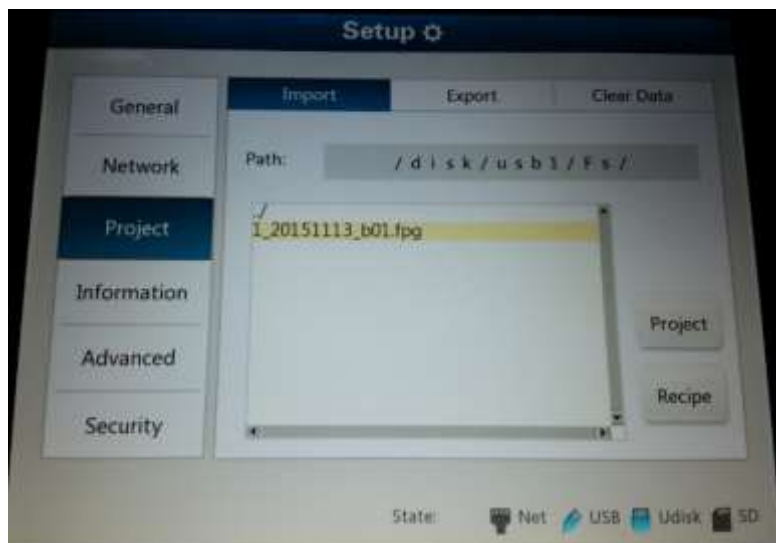

Fig. 31

④ Select the package file in the USB disk on the tab page "Import" (if project uploading to a USB disk is needed, please select the tab page "Export". The path for uploading the project file needs to be given), and wait till data transmission is completed, as shown in Fig. 32.



(a)

VEDA HCT User Manual

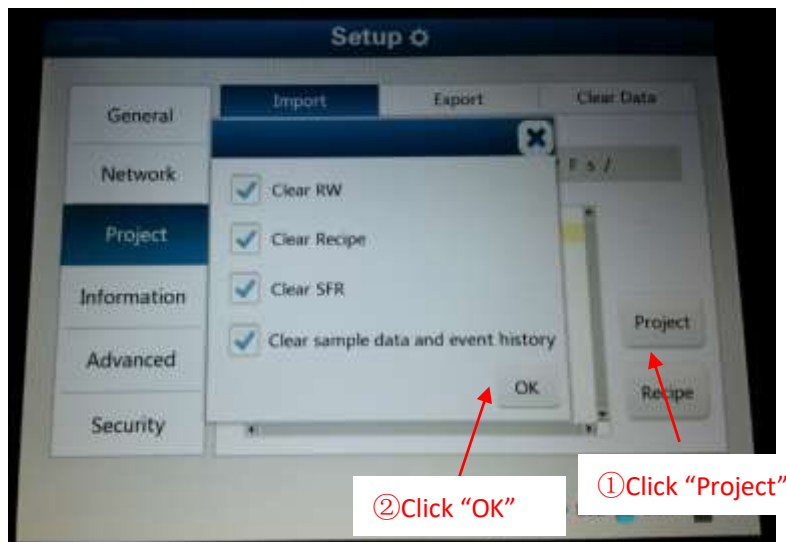

(b)



(c)

Fig. 32

2.4.3 Project uploading

①Click the "Upload" icon on the tool bar, set the communication mode, select to upload the project, and start to upload the project, as shown in Fig. 20.

VEDA HCT User Manual

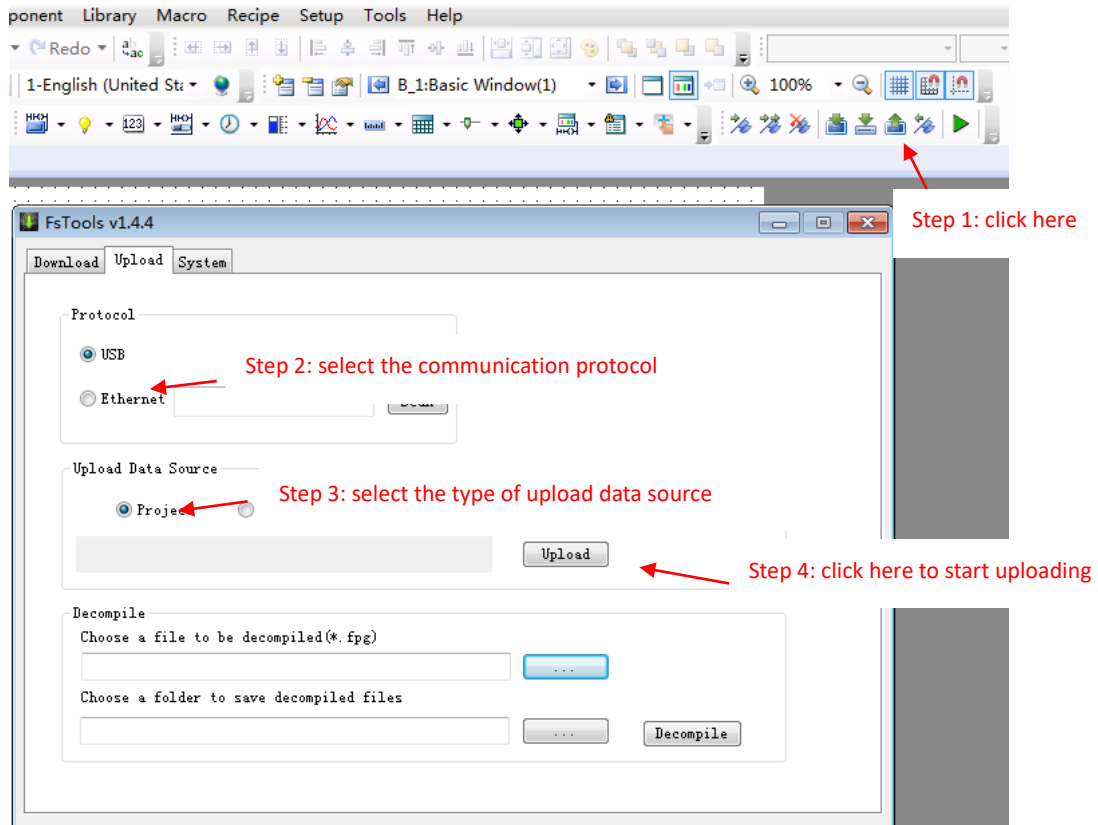

Fig. 20

② Enter the password for uploading, as shown in Fig. 21. The default password is “888888” which can be modified in “Global Settings”, as shown in Fig. 22.



Fig. 21

VEDA HCT User Manual

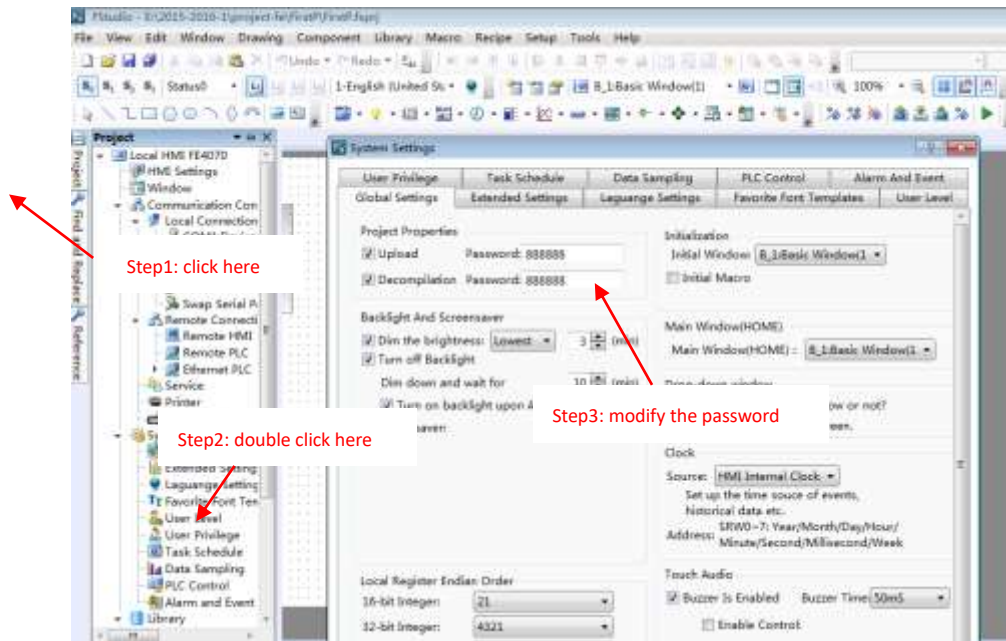

Fig. 22

③ Select the project uploading path and save the file name, and click “Save”.

④ If the screen is correctly connected to the computer, the packaging operation will be started for uploading. Select the “Project” option, and click the “Upload” button, as shown in Fig. 23. When the uploading operation is finished, the “Uploading Success!” dialog box pops up, as shown in Fig. 24. Then click the “OK” button.

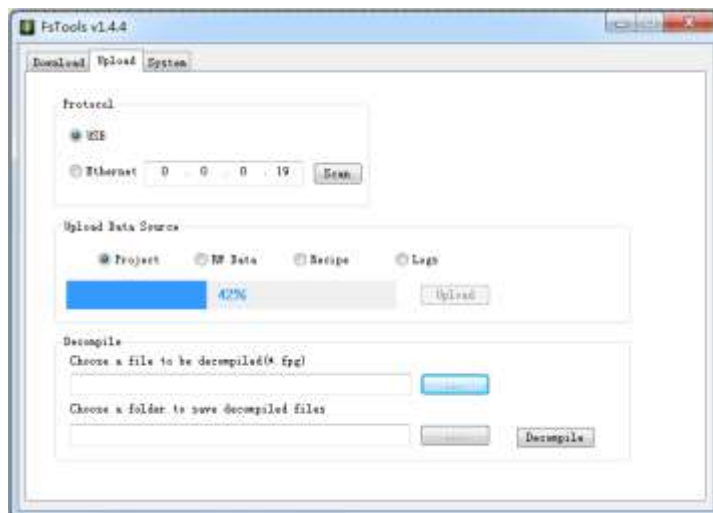

Fig. 23

VEDA HCT User Manual

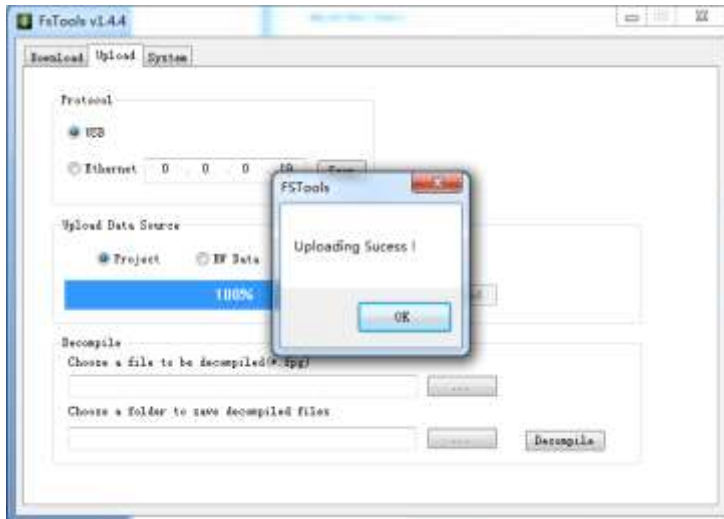

Fig. 24

2.4.4 Project uploading to USB disk.

The uploading to USB disk is similar to the downloading from USB disk. Please see the details in the [Quick start/Project download and upload/Project Downloading from USB disk](#).

Select “Export the Project” in the 4th step.

2.4.5 Project decompiling

The project upload package file is operated for the project decompiling. The file type is fpg. Decompiling can create a project package. The function of project package can be seen in [Quick start/Project download and upload/Project uploading](#) or [Quick start/Project download and upload/Project uploading to USB disk](#).

①Firstly, click the tool button “Decompile”, select the package fpg file, set the project saving path, and click the “Decompile” button, as shown in Fig. 17.

VEDA HCT User Manual

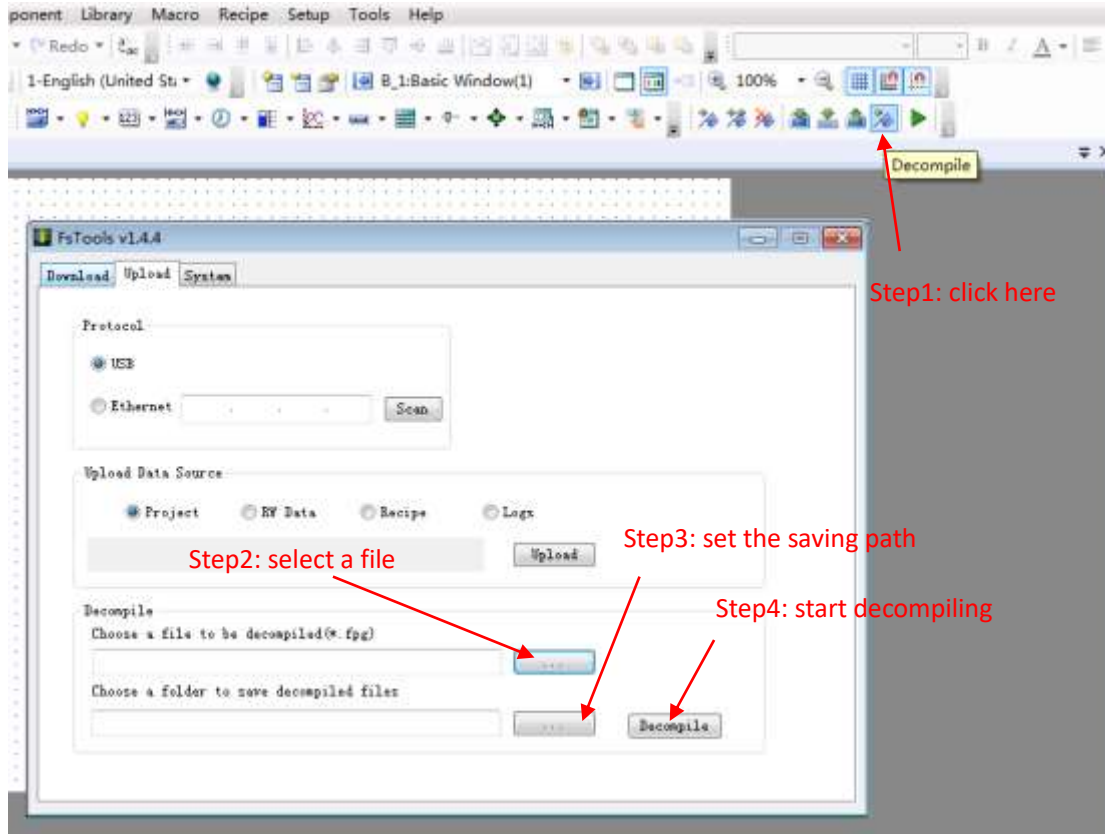

Fig. 17

② Enter the password for decompiling. The default password is “888888” which can be modified can viewed in the “General Setting” of the software, as shown in Fig. 18.



Fig. 18

③ After the “Decompile Success!” dialog box appears, click “OK” to complete the decompiling, as shown in Fig. 19.

VEDA HCT User Manual



Fig. 19

3 Description for communication connection

DELTA

- DELTA DVP series RS232 cable



- DELTA DVP series RS485-2 cable

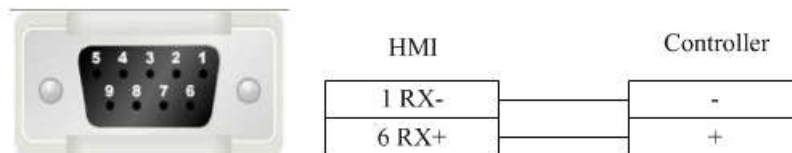

- Registers supported by DELTA DVP:

Device	Bit Address	Word Address	Format	Notes
External output node	Y0-9999	---	O000	
External input node	X0-9999	---	O000	
Internal auxiliary node	M0-9999	---	DDDD	
Sequence control node	S0-9999	---	DDDD	
Timer node	T0-9999	---	DDDD	
Counter node	C0-9999	---	DDDD	
Timer buffer	---	TV0-9999	DDDD	
Counter buffer	---	CV0-127	DDD	
Counter buffer (32 bit)	---	CV2 232-255	DDD	
Data register	---	D0-65535	DDDDD	

VEDA HCT User Manual

FATEK

- FATEK FB series RS232 cable

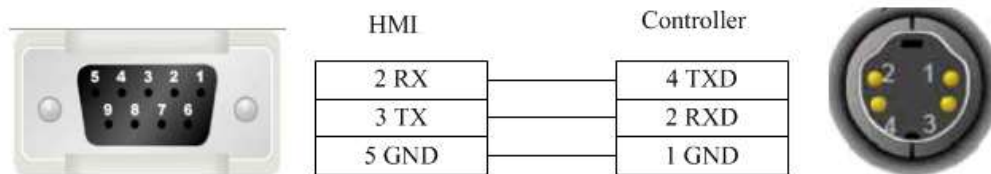

- FATEK FB special series RS232 cable

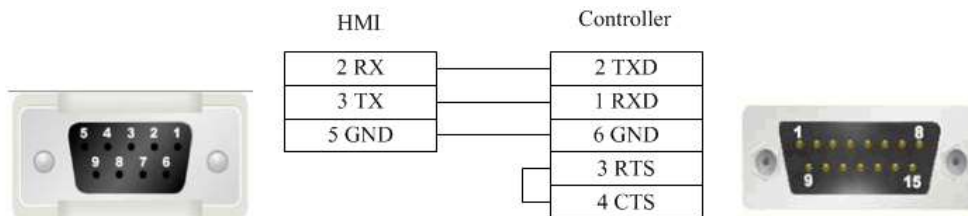

- FATEK FB series CB module RS232 cable

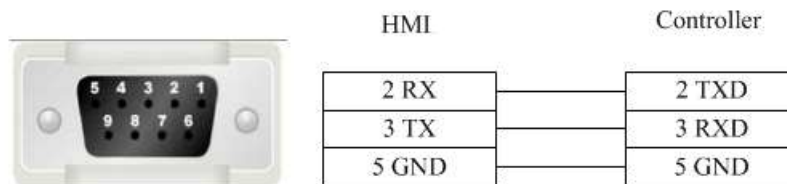

- FATEK FB series R485-2 cable

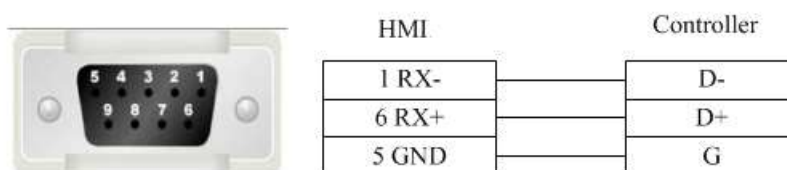

- registers supported by FATEK FB

Device	Bit Address	Word Address	Format	Notes
External output node	Y0-9999	---	DDDD	
External inputnode	X0-9999	---	DDDD	
Internal auxiliary node	M0-9999	---	DDDD	
Sequence control node	S0-9999	---	DDDD	
Timer node	T0-9999	---	DDDD	

VEDA HCT User Manual

Counter node	C0-9999	---	DDDD	
Data register	---	R0-9999	DDDD	
Data register	---	D0-9999	DDDD	
Timer buffer	---	T0-9999	DDDD	
Counter buffer	---	C0-199	DDD	
Counter buffer (32bit)	---	DRC200-255	DDD	

Flexem

1 flexem_fl2n_mistubishi_fx2n_compatible

Flexem(MISTUBISHI FX2N COMPATIBLE)

- Flexem FL2N series RS232 cable

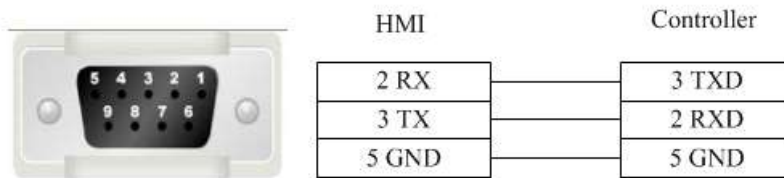

- Flexem FL2N series RS485-2 cable

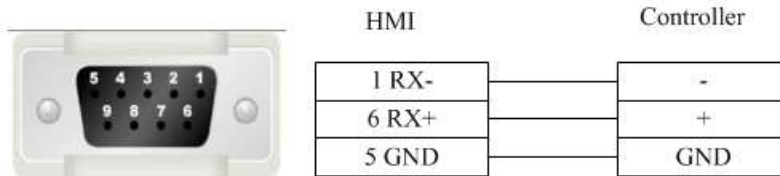

- Registers supported by Flexem FL2N(MISTUBISHI FX2N COMPATIBLE)

Device	Bit Address	Word Address	Format	Notes
External input node	X000-571	---	OOO	
External output node	Y000-571	---	OOO	
Internal auxiliary node	S0000-9999	---	DDDD	
Special auxiliary node	SM8000-9999	---	DDDD	
Timer node	T_bit000-255	---	DDD	
Counter node	C_bit000-255	---	DDD	
Timer buffer	---	T_word000-255	DDD	
Counter buffer	---	C_word000-255	DDD	
Counter buffer (32 bit)	---	C_dword200-255	DDD	
Data register	---	D0000-7999	DDDD	
Special data register	---	SD8000-9999	DDDD	

VEDA HCT User Manual

2 flexem_fl2n_modbus

FLEXEM FL2N (Modbus compatible protocol)

- Flexem FL2N series RS232 cable

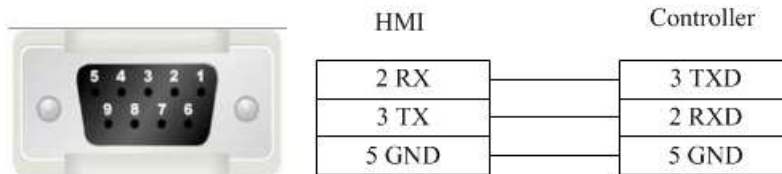

- Flexem FL2N series RS485-2 cable

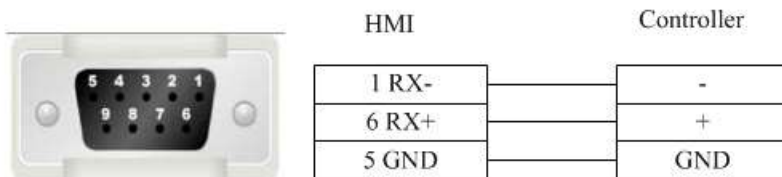

- Registers supported by Flexem FL2N (Modbus)

Device	Bit Address	Word Address	Format	Notes
External input node	X0-571	---	OOO	
External output node	Y00-571	---	OOO	
Internal auxiliary node	S0-999	---	DDD	
Internal auxiliary node	M0-2047	---	DDDD	
Special auxiliary node	SM0-511	---	DDD	
Timer node	T_bit0-255	---	DDD	
Counter node	C_bit0-255	---	DDD	
Analog output register	---	AQ0-255	DDD	
Analog input register	---	AI0-255	DDD	
Timer buffer	---	T_word0-255	DDD	
Counter buffer	---	C_word0-255	DDD	
Counter buffer (32 bit)	---	C_dword200-255	DDD	
Data register	---	D0-4095	DDDD	
Special data register	---	SD0-511	DDDD	

3 Differences between Flexem FL2N(Mistubishi FX2N Compatable) and Flexem FL2N(Modbus)

Differences between FLEXEM FL2N(MISTUBISHI FX2N COMPATIBLE) and FLEXEM FL2N(modbus): FLEXEM FL2N(MISTUBISHI FX2N COMPATIBLE) is compatible with Mitsubishi, while FLEXEM FL2N(modbus) is compatible with MODBUS.

Additional description:

VEDA HCT User Manual

① If modbus applies PLC Addresses (Base 1), please refer to the table below for the address correspondence

Device	Type	Address	Protocol address	Function code
Y	Bit	Y0-377	0001-0256	1,5,15
X	Bit	x0-377	1201-1456	1,5,15 2
M	Bit	M0-M2047	2001-4048	1,5,15
SM	Bit	SM0-SM511	4401-4912	1,5,15
S	Bit	S0-S999	6001-7000	1,5,15
T	Bit	T0-T255	8001-8256	1,5,15
C	Bit	C0-C255	9201-9456	1,5,15
D	Word	D0-D4095	0001-4096	3,6,16
SD	Word	SD0-SD511	8001-8512	3,6,16
T	Word	T0-T255	9001-9256	3,6,16
C	Word	C0-C199	9501-9700	3,6,16
C	Double word	C200-C255	9701-9756	3,16

② If modbus applies Protocol Addresses (Base 0), please refer to the table below for the address correspondence

Device	Type	Address	Protocol address	Function code
Y	Bit	Y0-377	0000-0255	1,5,15
X	Bit	x0-377	1200-1455	1,5,15 2
M	Bit	M0-M2047	2000-4047	1,5,15
SM	Bit	SM0-SM511	4400-4911	1,5,15
S	Bit	S0-S999	6000-6999	1,5,15
T	Bit	T0-T255	8000-8255	1,5,15
C	Bit	C0-C255	9200-9455	1,5,15
D	Word	D0-D4095	0000-4095	3,6,16
SD	Word	SD0-SD511	8000-8511	3,6,16
T	Word	T0-T255	9000-9255	3,6,16
C	Word	C0-C199	9500-9699	3,6,16
C	Double word	C200-C255	9700-9755	3,16

HCFA

- HC series PLC series CPU port RS232 cable
HC serial port programming cable is used to communicate with the HMI device.

VEDA HCT User Manual

- HC series PLC circular 8-pin RS485-4 cable

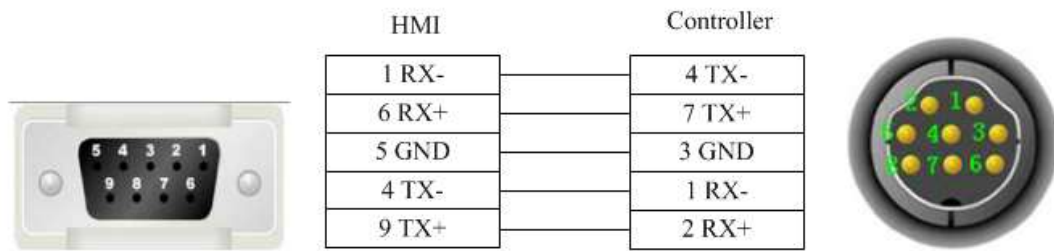

- Registers supported by HCFA HCA2s_HCA2c_HCA2_LX1N_LX1S

Device	Bit Address	Word Address	Format	Notes
Output relay	Y0-571	---	OOO	
Input relay	X0-571	---	OOO	
Internal relay	M0-7999	---	DDDD	
Timer contact	T_bit0-255	---	DDD	
Counter contact	C_bit0-255	---	DDD	
Stepping relay	S0-9999	---	DDDD	
Special internal relay	SM8000-9999	---	DDDD	
Data register	---	D_word0-7999	DDDD	
Special data register	---	SD8000-9999	DDDD	
Timer current value	---	T_word0-255	DDD	
Counter current value	---	C_word0-255	DDD	

- Registers supported by HCFA HCA4

Device	Bit Address	Word Address	Format	Notes
Hold Relay	HR_bit 00.00-99.15	-----	DD.DD	
Data Relay	DM_bit 0000.00-6655.15	-----	DDDD.DD	
Link Relay	LR_bit 00.00-63.15	-----	DD.DD	
Auxiliary Relay	AR_bit 00.00-959.15	-----	DD.DD	
Channel I/O	CIO_IR_bit 000.00-511.15	-----	DDD.DD	
Counter Relay	-----	CNT_word 000-511	DDD	
Timer Relay	-----	TIM_word 000-511	DDD	
Hold Register	-----	HR_word 00-99	DD	
Data Register	-----	DM_word 0000-6655	DDDD	
Link Register	-----	LR_word 00-63	DD	
Auxiliary Register	-----	AR_word 000-959	DDD	
Channel I/O Register	-----	CIO_IR_word 000-511	DDD	

- Registers supported by HCFA HCA8s_HCA8c_HCA8

Device	Bit Address	Word Address	Format	Notes
Output relay	Y0-764	---	OOO	
Input relay	X0-764	---	OOO	
Internal relay	M0-7999	---	DDDD	

VEDA HCT User Manual

Timer contact	T_bit0-511	---	DDD	
Counter contact	C_bit0-511	---	DDD	
Stepping relay	S0-4095	---	DDDD	
Special internal relay	SM8000-9999	---	DDDD	
Data register bit	D_bit0.0-7999.F	---	DDDD.H	
Data register	---	D_word0-7999	DDDD	
Special data register	---	SD8000-9999	DDDD	
Timer current value	---	T_word0-255	DDD	
File register		R0-32767	DDDDD	
Counter current value	---	C_word0-199	DDD	
Counter current value	---	C_dword200-255	DDD	

Hitachi

- EHV-CPU_APPLICATION series programming cable

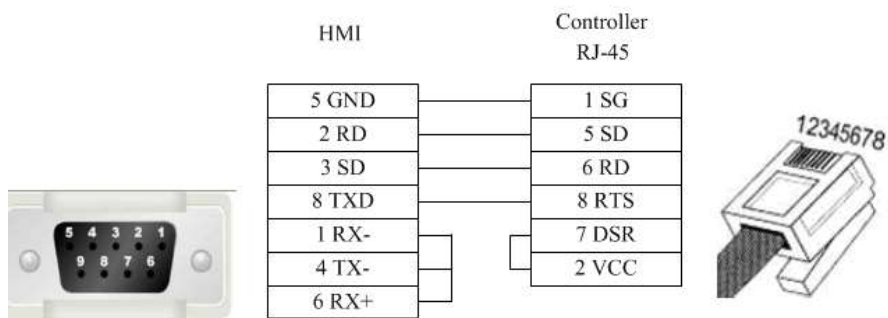

- EHV-CPU_APPLICATION series RS232 cable

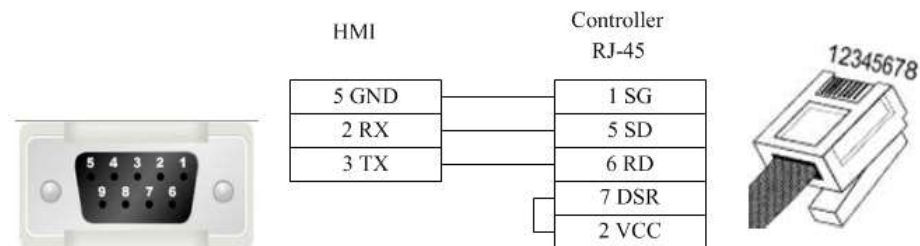

- EHV-CPU_APPLICATION series RS485-4 cable

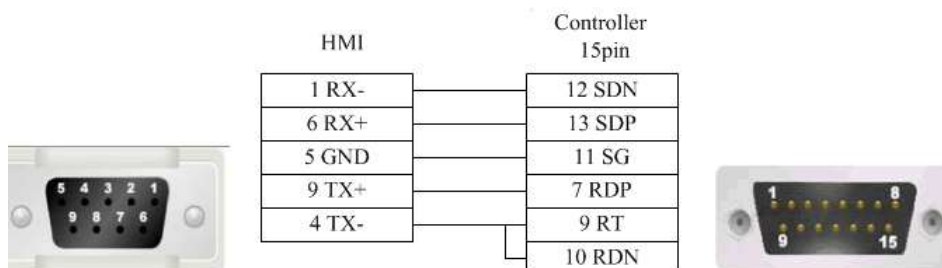

VEDA HCT User Manual

- Registers supported by EHV-CPU_APPLICATION

Device	Bit Address	Word Address	Format	Notes
Input	X_bit0-FFFF	-----	HHHH	
Output	Y_bit0-FFFF	-----	HHHH	
Internal Output	R_bit0-FFFF	-----	HHHH	
CPU Link	L_bit0-FFFF	-----	HHHH	
Data Area	M_bit0-FFFF	-----	HHHH	
Timer	T_C_bit0-FFFF	-----	HHHH	
Counter	C_L_bit0-FFFF	-----	HHHH	
Input	-----	WX0-FFFF	HHHH	
Output	-----	WY0-FFFF	HHHH	
Internal Output	-----	WR0-FFFF	HHHH	
CPU Link	-----	WL0-FFFF	HHHH	
Data Area	-----	WM0-FFFF	HHHH	
Timer Counter	-----	TC0-FFFF	HHHH	
Data	-----	DIF0-FFFF	HHHH	
Data	-----	DFN0-FFFF	HHHH	

- Notice (Similar for other address types)

PLC(Format)	HMI(Format)
WY100(HDD)	WY100(HHH)
WY101(HDD)	WY101(HHH)
WY102(HDD)	WY102(HHH)
...	...
WY114(HDD)	WY10E(HHH)
WY115(HDD)	WY10F10F(HHH)

HollySys

- HollySys LM series RS232 cable

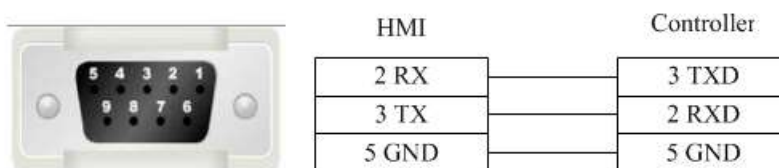

- HollySys LM series RS485-2 cable

VEDA HCT User Manual

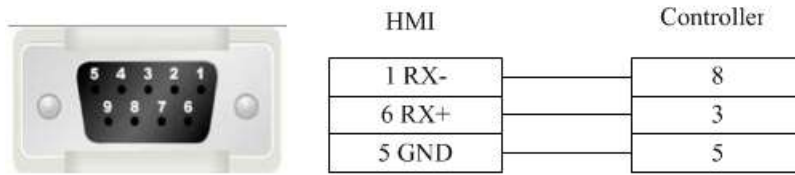

- Registers supported by HollySys LM:

Device	Bit Address	Word Address	Format	Notes
External output node	Q0.0-4095.7	---	DDDD.O	
External inputnode	I0.0-4095.7	---	DDDD.O	
Intermediate auxiliary register bit	M100.0-62535.7	---	DDDDD.O	M0-99(Used by systematic diagnoses)
Analog output register	---	QW0-510	DDDD	
Analog input register	---	IW0-4095	DDDD	
Intermediate register	---	MW0-8188	DDDD	
Intermediate register(32 bit)	---	MD0-8186	DDDD	

Inovance

- Inovance_H2u series CPU port RS232 cable
Inovance serial port programming cable is used to communicate with the HMI device.

- Inovance_H2U series communication port RS232 cable

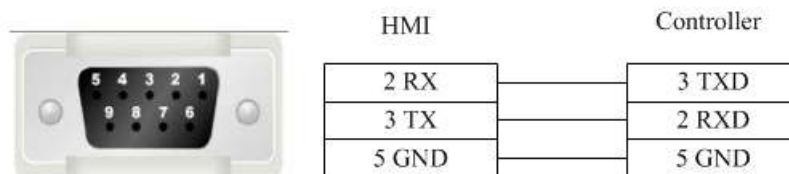

- Inovance_H2u series RS485-4 cable

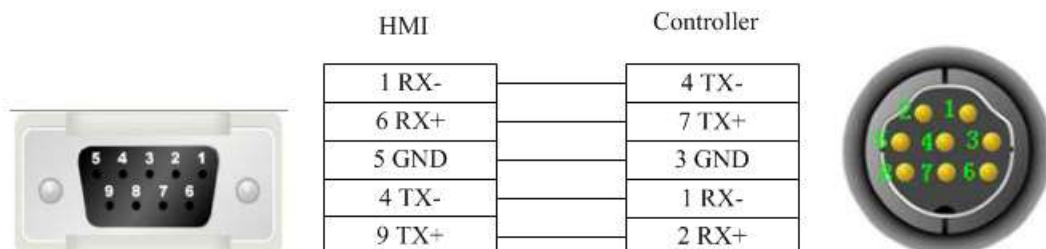

- Inovance_H2u series module RS485-4 cable

VEDA HCT User Manual

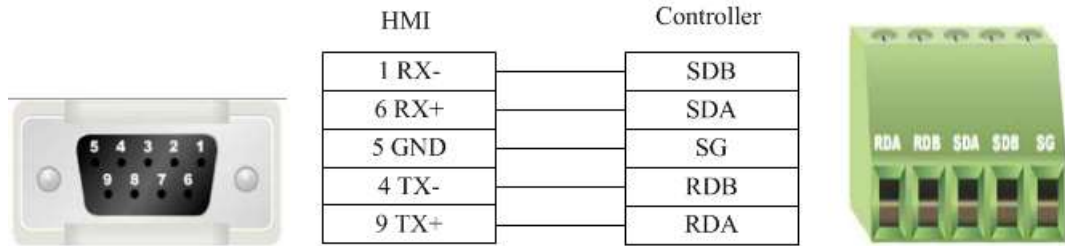

- Registers supported by Inovance_H2U

Device	Bit Address	Word Address	Format	Notes
Output relay	Y0-571	---	OOO	
Input relay	X0-571	---	OOO	
Internal relay	M0-7999	---	DDDD	
Timer contact	T_bit0-255	---	DDD	
Counter contact	C_bit0-255	---	DDD	
Stepping relay	S0-9999	---	DDDD	
Special internal relay	SM8000-9999	---	DDDD	
Data register	---	D_word0-7999	DDDD	
Special data register	---	SD8000-9999	DDDD	
Timer current value	---	T_word0-255	DDD	
Counter current value	---	C_word0-199	DDD	
Counter current value	---	C_dword200-255	DDD	

Kewei

- Kewei cable

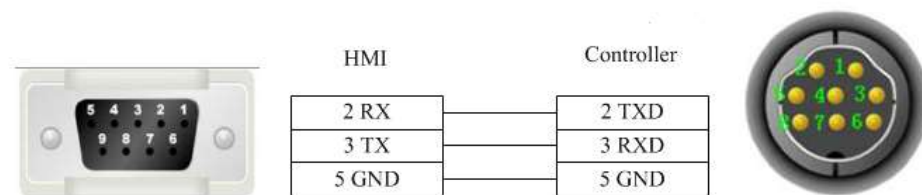

- Registers supported by Kewei

Device	Bit Address	Word Address	Format	Notes
Output relay	Y0-377	---	OOO	
Input relay	X0-377	---	OOO	
Internal relay	M0-7999	---	DDDD	
Timer contact	T_bit0-255	---	DDD	
Counter contact	C_bit0-255	---	DDD	
Stepping relay	S0-9999	---	DDDD	
Special internal relay	SM8000-9999	---	DDDD	

VEDA HCT User Manual

Data register	---	D_word0-7999	DDDD	
Special data register	---	SD8000-9999	DDDD	
Timer current value	---	T_word0-255	DDD	
Counter current value	---	C_word0-199	DDD	
Counter current value	---	C_dword200-255	DDD	

KEYENCE

- KEYENCE KV-1000-3000 series CPU port RS232 cable

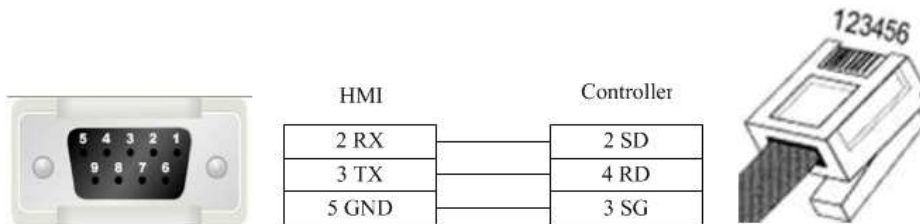

- Registers supported by KEYENCE KV-1000-3000:

Device	Bit Address	Word Address	Format	Notes
Latch relay	LR0.0-15999.15	---	DDDDD.DD	
Internal auxiliary relay	MR0.0-15999.15	---	DDDDD.DD	
Control relay	CR0.0-639.15	---	DDD.DD	
relay	R0.0-15999.15	---	DDDDD.DD	
Extended data memory	---	FM0-32767	DDDDD	
Extended data memory	---	EM0-65534	DDDDD	
High speed counter comparator	---	TC0-3999	DDDD	
Timer	---	TM0-511	DDD	
Counter	---	CM0-9999	DDDD	
Variable address register	---	Z0-12	DD	
Data memory	---	DM0-65534	DDDDD	

Kinco

- Kinco series RS232 cable

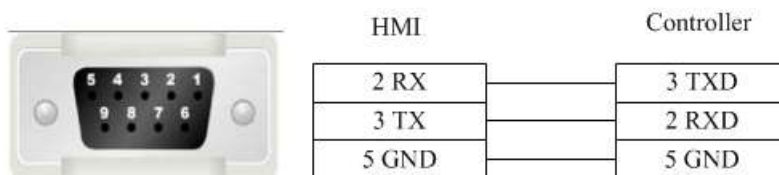

VEDA HCT User Manual

- Kinco series RS485-2 cable

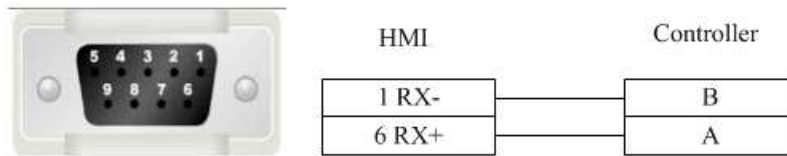

- Registers supported by Kinco

Device	Bit Address	Word Address	Format	Notes
System internal/external input node	I0.0-31.7	---	DD.O	
System internal/external output node	Q0.0-31.7	---	DD.O	
Intermediate auxiliary register	M0.0-31.7	---	DD.O	
Intermediate bit register	VW0.0-4094.7	---	DDDD.O	
Analog input register	---	AIW0-62	DD	
Analog output register	---	AQW0-62	DD	
Intermediate register	---	VW0-4094	DDDD	
Intermediate register	---	VD0-4092	DDDD	

LS

1 ls_mster_cpu_serial

- LS Master_K CPU Serial S232 cable

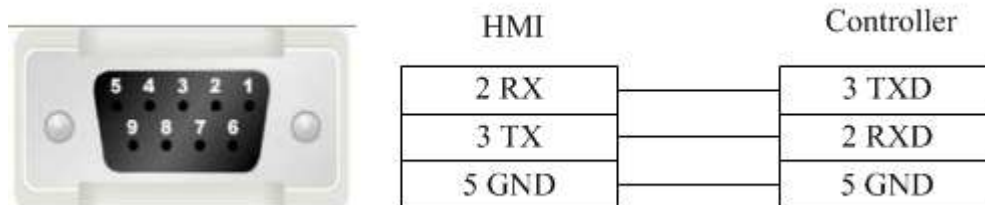

- Registers supported by LS Master_K CPU Serial

VEDA HCT User Manual

Device	Bit Address	Word Address	Format	Notes
Auxiliary Relay	M0.0-4096.F	-----	DDDD.F	
I/O Relay	P0.0-4096.F	-----	DDDD.F	
Link Relay	L0.0-4096.F	-----	DDDD.F	
Keep Relay	K0.0-4096.F	-----	DDDD.F	
Special Relay	F0.0-4096.F	-----	DDDD.F	
Data Register Bit	D_bit0.0-4096.F	-----	DDDD.F	
Timer Bit	T_bit0.0-4096.F	-----	DDDD.F	
Counter Bit	C_bit0.0-4096.F	-----	DDDD.F	
Data Register	-----	D0-9999	DDDD	
Timer	-----	T0-4096	DDDD	
Counter	-----	C0-4096	DDDD	
Auxiliary Relay	-----	M_Word0-4096	DDDD	
Special Relay	-----	F_Word0-4096	DDDD	
Link Relay	-----	L_Word0-4096	DDDD	

2 ls_xgt_cpu_serial

- LS XGT CPU Serial RS232 cable

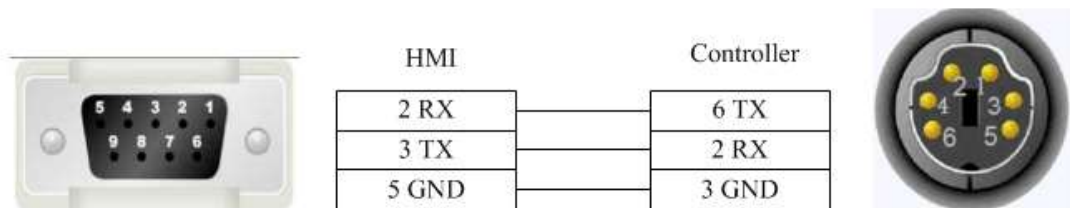

- Registers supported by LS XGT CPU Serial

Device	Bit Address	Word Address	Format	Notes
Auxiliary Relay	M_Bit0.0-16383.F	----	DDDDD.F	
I/O Relay	P_Bit0.0-16383.F	----	DDDDD.F	
Keep Relay	K_Bit0.0-65535.F	----	DDDDD.F	
Special Relay	F_Bit0.0-16383.F	----	DDDDD.F	
Timer Bit	T_Bit0.0-9999.F	----	DDDD.F	
Counter Bit	C_Bit0.0-9999.F	----	DDDD.F	
Index Relay	Z_Bit0.0-9999.F	----	DDDD.F	
Index Relay	ZR_Bit0.0-163839.F	----	DDDDDD.F	
Link Relay	L_Bit0.0-32767.F	----	DDDDD.F	
Communication Relay	N_Bit0.0-81819.F	----	DDDDD.F	
Data Relay	D_Bit0.0-163839.F	----	DDDDDD.F	
File Relay	R_Bit0.0-163839.F	----	DDDDDD.F	

VEDA HCT User Manual

Data Register	-----	D0-10239	DDDDD	
I/O Relay	-----	P0-9999	DDDD	
Auxiliary Relay	-----	M0-9999	DDDD	
Keep Register	-----	K0-9999	DDDD	
Special Register	-----	F0-9999	DDDD	
Timer	-----	T_SV0-9999	DDDD	
Counter	-----	C_SV0-9999	DDDD	
Timer	-----	T_CV0-9999	DDDD	
Counter	-----	C_CV0-9999	DDDD	
Index Register	-----	Z0-9999	DDDD	
Step Control Register	-----	S0-9999	DDDD	
Link Register	-----	L0-9999	DDDD	
Communication Register	-----	N0-9999	DDDD	
File Register	-----	R0-10239	DDDDD	
Index Register	-----	R0-10239	DDDDD	

MEGMEET

- MEGMEET M280 series CPU port RS232 cable

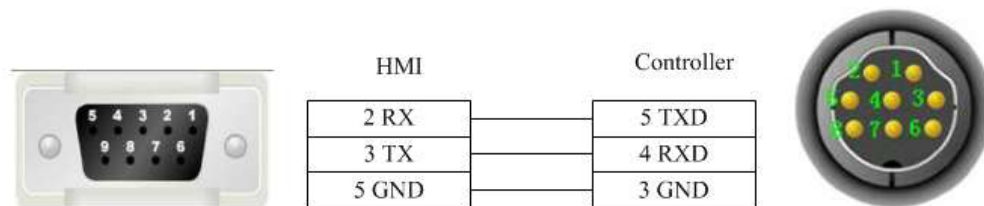

- MEGMEET M280 series communication port RS232 cable

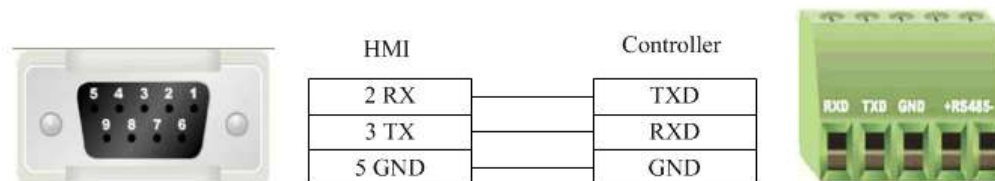

- MEGMEET M280 series RS485-2 cable

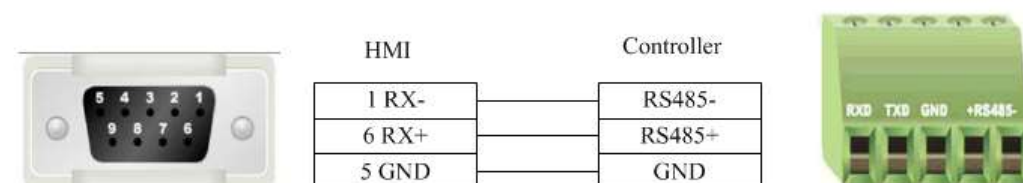

VEDA HCT User Manual

- Registers supported by MEGMEET M280

Device	Bit Address	Word Address	Format	Notes
Output relay	Y0-571	---	OOO	
Input relay	X0-571	---	OOO	
Internal relay	M0-10239	---	DDDDD	
Timer contact	T_bit0-511	---	DDD	
Counter contact	C_bit0-511	---	DDD	
Stepping relay	S0-4096	---	DDDD	
Special internal relay	SM0-511	---	DDD	
Auxiliary register	---	R0-32767	DDDDD	
Data register	---	D_word0-7999	DDDD	
Special data register	---	SD0-511	DDD	
Variable address register	---	Z0-15	DD	
Timer current value	---	T_word0-511	DDD	
Counter current value	---	C_word0-199	DDD	
Counter current value	---	C_dword200-255	DDD	

MIKOM

- MIKOM MX1H series CPU port RS232 cable



- MIKOM MX1H series RS485-2 cable

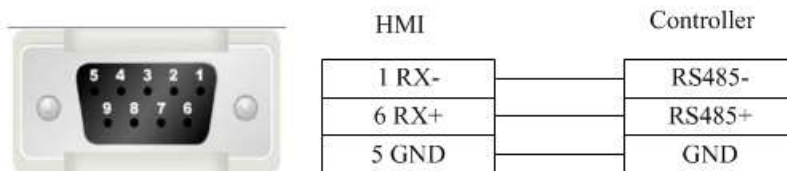

- Registers supported by MIKOM MX1H

Device	Bit Address	Word Address	Format	Notes
Output relay	Y0-777	---	OOO	
Input relay	X0-777	---	OOO	
Internal relay	M0-4095	---	DDDD	
Timer contact	T_bit0-511	---	DDD	

VEDA HCT User Manual

Counter contact	C_bit0-511	---	DDD	
Stepping relay	S0-1535	---	DDDD	
Special internal relay	SM0-511	---	DDD	
Auxiliary register	---	Un 0-199	DDD	n: 0-7
Data register	---	D0-32767	DDDDD	
Special data register	---	SD0-511	DDD	
Variable address register	---	Z0-255	DDD	
Timer current value	---	T_word0-511	DDD	
Counter current value	---	C_word0-199	DDD	
Counter current value	---	C_dword200-255	DDD	

Mitsubishi

1 Mitsubishi_FX0S_FX0N_FX1S_FX1N_FX2

- Mitsubishi FX series CPU port RS232 cable
Mitsubishi serial programming cable is used to communicate with the HMI device.

- Mitsubishi FX series communication port RS232 cable

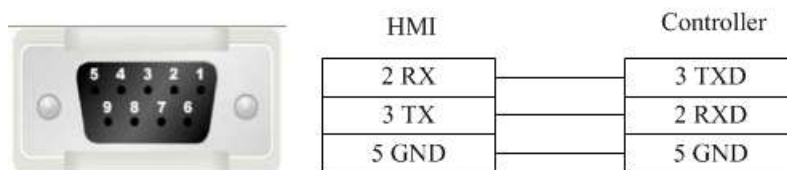

- Mitsubishi FX series RS485-4 cable

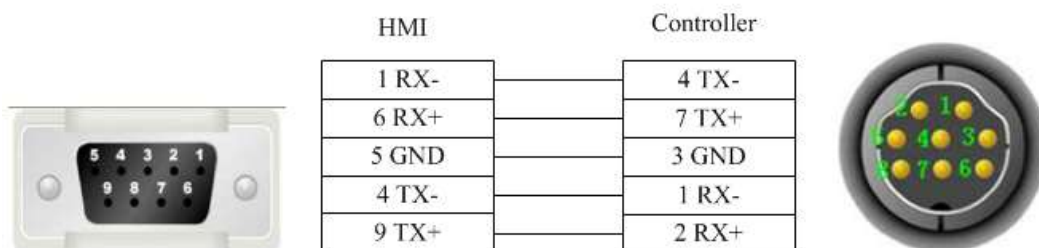

- Registers supported by Mitsubishi FX0S_FX0N_FX1S_FX1N_FX2

Device	Bit Address	Word Address	Format	Notes
Output relay	Y0-571	---	OOO	
Input relay	X0-571	---	OOO	
Internal relay	M0-7999	---	DDDD	
Timer contact	T_bit0-255	---	DDD	

VEDA HCT User Manual

Counter contact	C_bit0-255	---	DDD	
Stepping relay	S0-9999	---	DDDD	
Special internal relay	SM8000-9999	---	DDDD	
Data register	---	D_word0-7999	DDDD	
Special data register	---	SD8000-9999	DDDD	
Timer current value	---	T_word0-255	DDD	
Counter current value	---	C_word0-255	DDD	

2 Mitsubishi FX2N

- Mitsubishi FX series CPU port RS232 cable

Mitsubishi serial port programming cable is used to communicate with the HMI device.

- Mitsubishi FX series communication port RS232 cable

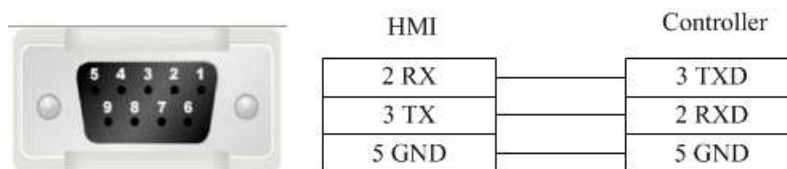

- Mitsubishi FX series RS485-4 cable

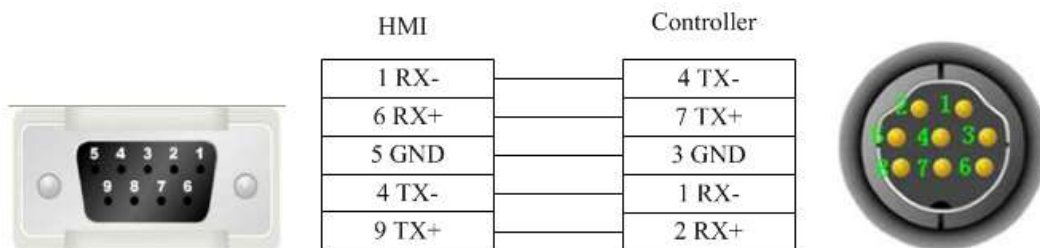

- Registers supported by Mitsubishi FX2N:

Device	Bit Address	Word Address	Format	Notes
Output relay	Y0-571	---	OOO	
Input relay	X0-571	---	OOO	
Internal relay	M0-7999	---	DDDD	
Timer contact	T_bit0-255	---	DDD	
Counter contact	C_bit0-255	---	DDD	
Stepping relay	S0-9999	---	DDDD	
Special internal relay	SM8000-9999	---	DDDD	
Data register	---	D_word0-7999	DDDD	
Special data register	---	SD8000-9999	DDDD	
Timer current value	---	T_word0-255	DDD	

VEDA HCT User Manual

Counter current value	---	C_word0-199	DDD	
Counter current value	---	C_dword200-255	DDD	

3 Mitsubishi FX3U_FX3G

▪ Mitsubishi FX series CPU port RS232 cable

The Mitsubishi serial port cable is used to communicate between the HMI device and the programming device.

▪ Mitsubishi FX series communication port RS232 cable

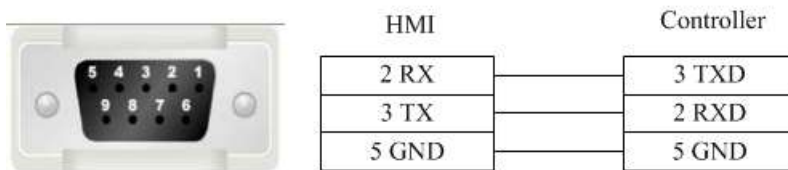

▪ Mitsubishi FX series RS485-4 cable

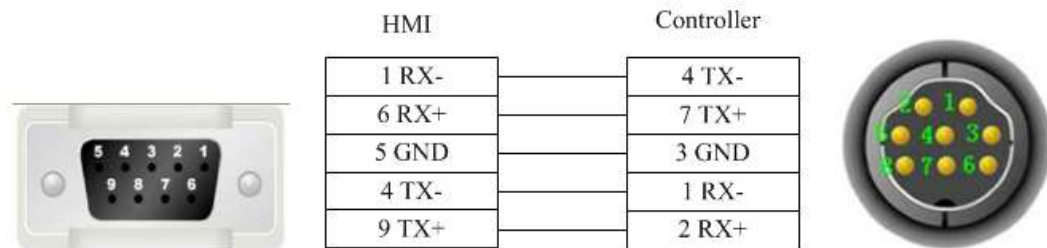

▪ Registers supported by Mitsubishi FX3U_FX3G

Device	Bit Address	Word Address	Format	Notes
Output relay	Y0-764	---	OOO	
Input relay	X0-764	---	OOO	
Internal relay	M0-7999	---	DDDD	
Timer contact	T_bit0-511	---	DDD	
Counter contact	C_bit0-255	---	DDD	
Stepping relay	S0-4095	---	DDDD	
Special internal relay	SM8000-9999	---	DDDD	
Data register bit	D_bit0.0-127999.F	---	DDDDDD.H	
Data register	---	D_word0-17999	DDDDD	
Special data register	---	SD8000-9999	DDDD	
Timer current value	---	T_word0-511	DDD	
File register	---	R0-32767	DDDDD	
Counter current value	---	C_word0-199	DDD	
Counter current value	---	C_dword200-255	DDD	

VEDA HCT User Manual

4 Mitsubishi Melsec Q

- Mitsubishi Melsec Series Q RS232 cable

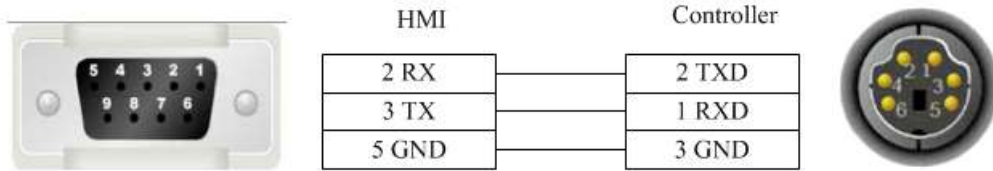

- Mitsubishi Melsec Series Q (Special) RS232 cable

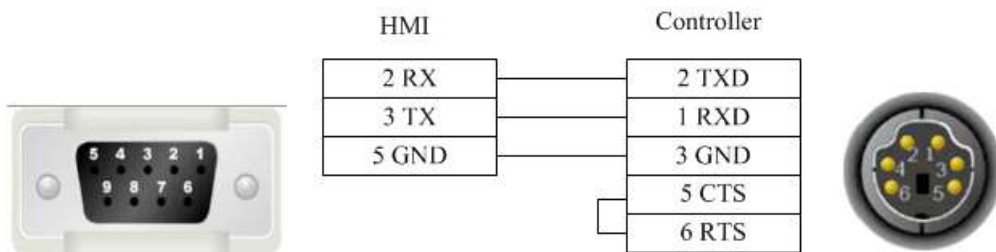

- Mitsubishi Melsec Series Q C24 communication module RS232 cable

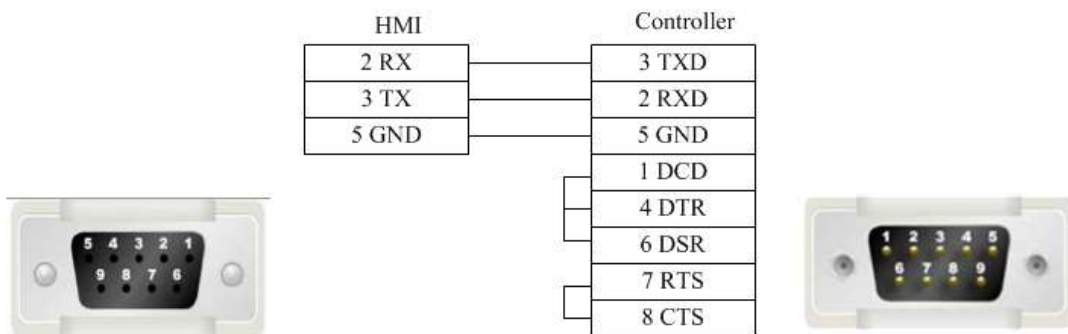

- Mitsubishi Melsec Series Q C24 communication module RS485-4 cable

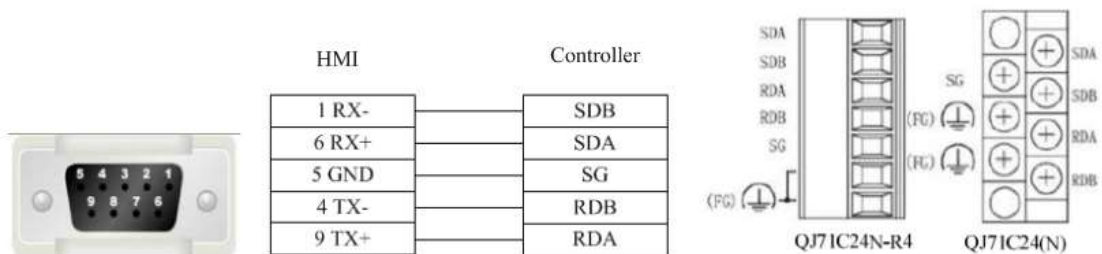

- Registers supported by Mitsubishi Melsec Q:

Device	Bit Address	Word Address	Format	Notes
--------	-------------	--------------	--------	-------

VEDA HCT User Manual

Data output relay	DDY0-7FF	---	HHH	
Data input relay	DX0-7FF	---	HHH	
Stepping relay	S0-2047	---	DDDD	
Special link relay	SB0-3FF	---	HHH	
Counter coil	CC0-511	---	DDD	
Counter contact	CS0-511	---	DDD	
Accumulative timer coil	SC0-511	---	DDD	
Accumulative timer contact	SS0-511	---	DDD	
Timer coil	TC0-511	---	DDD	
Link relay	B0-7FF	---	HHH	
Variable address relay	V0-1023	---	DDDD	
Alarm	F0-1023	---	DDDD	
Latch relay	L0-2047	---	DDDD	
Internal relay	M0-8191	---	DDDD	
Output relay	Y0-7FF	---	HHH	
Input relay	X0-7FF	---	HHH	
Timer contact	TS0-511	---	DDD	
Data register	---	D0-11135	DDDDD	
File register	---	ZR0-65535	DDDDD	
Variable address register	---	Z0-9	D	
Stepping register	---	SW0-3FF	HHH	
File register	---	R0-32767	DDDDD	
Counter current value	---	CN0-511	DDD	
Accumulative timer current value	---	SN0-511	DDD	
Timer current value	---	TN0-511	DDD	
Link register	---	W0-7FF	HHH	

5 Mitsubishi_FX3U_ENET_L

▪ Mitsubishi_FX3U_ENET_L cable

Across connection

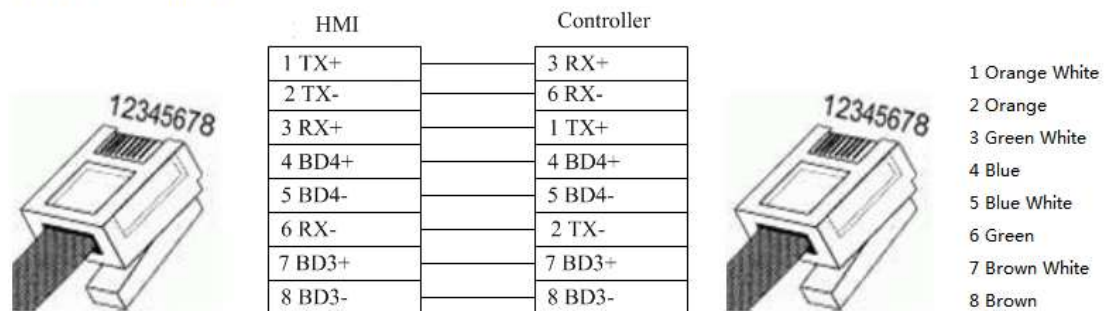

VEDA HCT User Manual

Direct connection

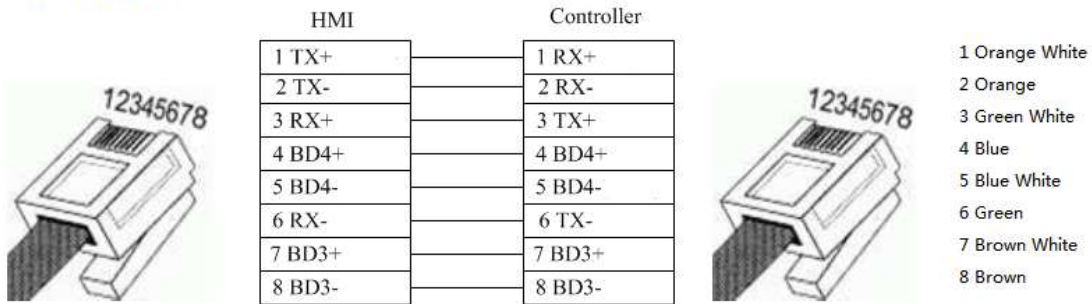

Registers supported by Mitsubishi_FX3U_ENET_L

Device	Bit Address	Word Address	Format	Notes
Output relay	Y0-377	---	OOO	
Input relay	X0-377	---	OOO	
Internal relay	M0-7999	---	DDDD	
Special internal relay	SM8000-8511	---	DDDD	
Stepping relay	S0-4095	---	DDDD	
Timer	T0-511	---	DDD	
Counter	C0-255	---	DDD	
Data relay	D_bit0-17999.15	---	DDDDD.DD	
Data register	---	D0-7999	DDDD	
Special register	---	SD8000-8511	DDDD	
File register	---	R0-32767	DDDDD	
Timer current value	---	TV0-511	DDD	
Counter current value	---	CV0-199	DDD	
Counter current value	---	CV2 200-255	DDD	

6 Mitsubishi_melsec_ethernet

Mitsubishi Melsec Ethernet (Ascii/Bin)

Mitsubishi_Melsec_Ethernet (Ascii/Bin) cable

Across connection

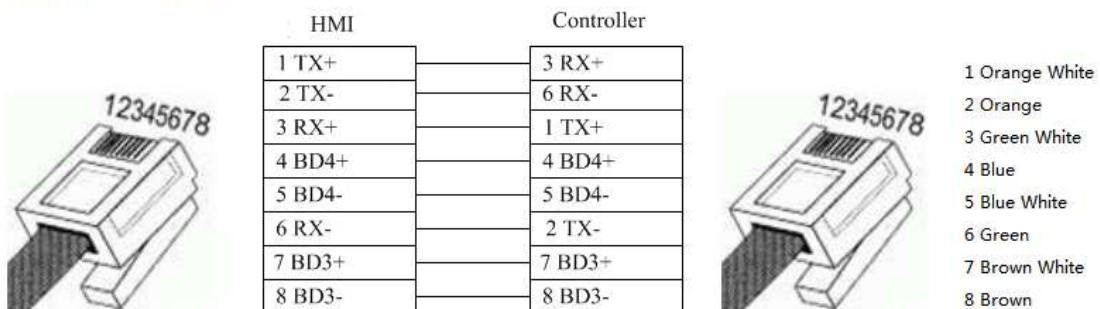

VEDA HCT User Manual

Direct connection

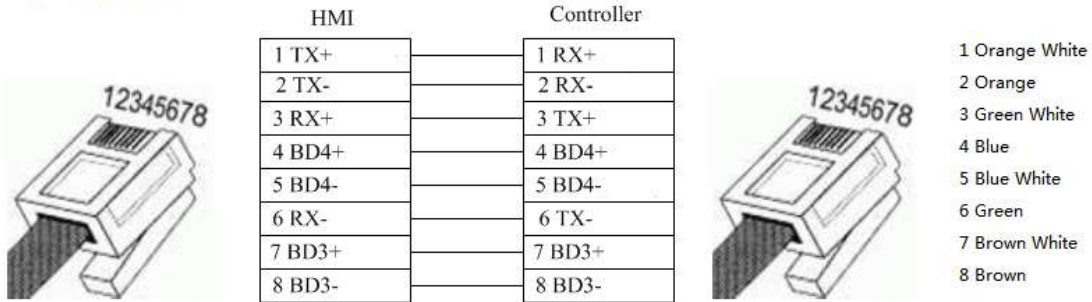

Registers supported by Mitsubishi_Melsec_Ethernet (Ascii/Bin)

Device	Bit Address	Word Address	Format	Notes
Output relay	Y0-FFFF	---	HHHH	
Input relay	X0-FFFF	---	HHHH	
Internal relay	M0-65535	---	DDDDD	
Special internal relay	SM0-65535	---	DDDDD	
Latch relay	L0-65535	---	DDDDD	
Alarm	F0-65535	---	DDDDD	
Variable address relay	V0-65535	---	DDDDD	
Link relay	B0-FFFF	---	HHHH	
Timer contact	TS0-65535	---	DDDDD	
Timer coil	TC0-65535	---	DDDDD	
Accumulative timer contact	SS0-65535	---	DDDDD	
Accumulative timer coil	SC0-65535	---	DDDDD	
Counter contact	CS0-65535	---	DDDDD	
Counter coil	CC0-65535	---	DDDDD	
Special link relay	SB0-FFFF	---	HHHH	
Stepping relay	S0-65535	---	DDDDD	
Data output relay	DY0-FFFF	---	HHHH	
Data input relay	DX0-FFFF	---	HHHH	
Data register	---	D0-65535	DDDDD	
Special register	---	SD0-65535		
Link register	---	W0-FFFF	HHHH	
Stepping register	---	SW0-FFFF	HHHH	
Timer current value	---	TN0-65535	DDDDD	
Accumulative timer current value	---	SN0-65535	DDDDD	
Counter current value	---	CN0-65535	DDDDD	
Variable address register	---	Z0-65535	DDDDD	
File register	---	R0-65535	DDDDD	
File register	---	ZR0-393216	DDDDDD	

Modbus

VEDA HCT User Manual

1 Modbus_RTU

- Modbus RTU series RS232 cable

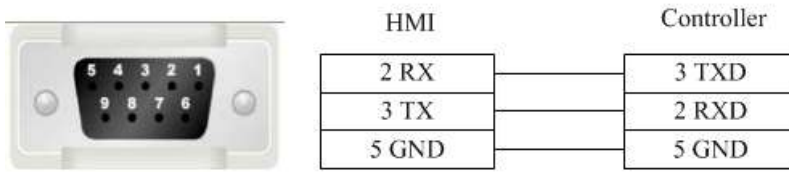

- Modbus RTU series RS485-2 cable

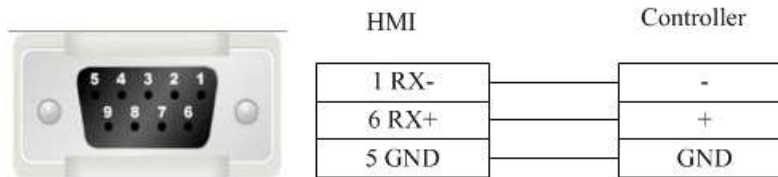

- Modbus RTU series RS485-4 cable

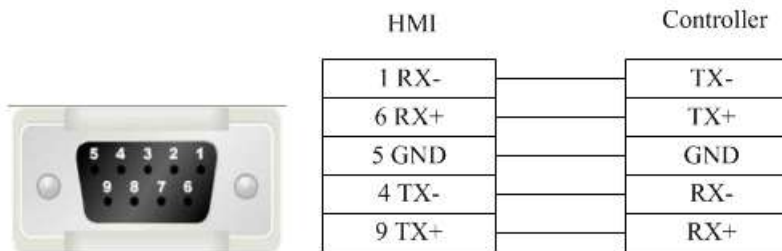

- Registers supported by RTU:

Device	Bit Address	Word Address	Format	Notes
System internal/external output node	0X1-65535	---	DDDDD	
System internal/external input node	1X1-65535	---	DDDDD	
Analog input data register	---	3X1-65535	DDDDD	
Data register	---	4X1-65535	DDDDD	

2 Modbus_RTU_Extend

Modbus RTU Extend

- Modbus RTU Extend series RS232 cable

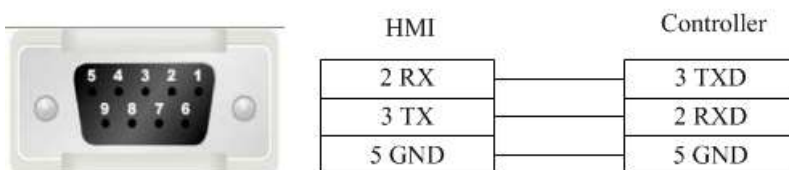

VEDA HCT User Manual

- Modbus RTU Extend series RS485-2 cable

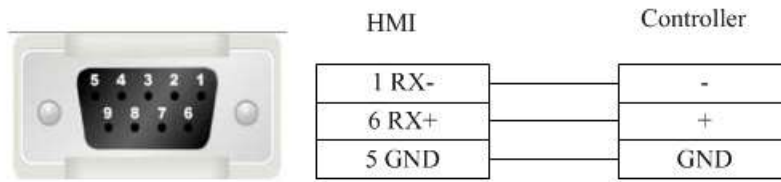

- Modbus RTU Extend series RS485-4 cable

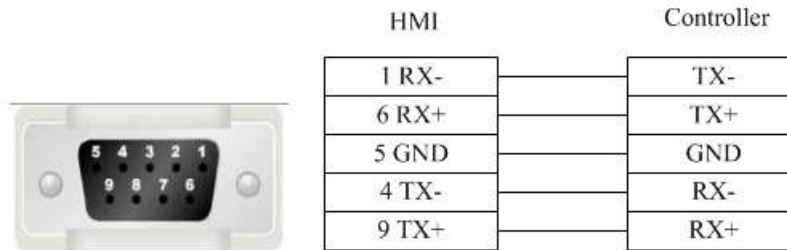

- Registers supported by Modbus RTU Extend:

Device	Bit Address	Word Address	Format	Notes
System internal/external output node	0X1-65535	---	DDDDD	
System internal/external input node	1X1-65535	---	DDDDD	
Analog input data bit	3X1_BIT1.0-65535.15	---	DDDDD.DD	
Data register bit	4X1_BIT1.0-65535.15	---	DDDDD.DD	
Analog input data register	---	3X1-65535	DDDDD	
Data register	---	4X1-65535	DDDDD	
Data register	---	5X1-65535	DDDDD	
Data register	---	6X1-65535	DDDDD	
Data register	---	3X-DINV1-65535	DDDDD	
Data register	---	4X-DINV1-65535	DDDDD	

- Notice:

4X_DINV and 3X_DINV are the big end format of double word 4X, and it is a word type address. For example, 4X3 is the hexadecimal 1234, 4X4 is the hexadecimal 5678, and 4X_DINV is the hexadecimal 12345678.

3 Differences between Modbus_RTU and Modbus_RTU_Extend

Many data memory such as analog input data bit, data register bit and function code data register are added into Modbus_RTU_Extend on the base of Modbus_RTU.

4 Modbus_TCP

- Modbus TCP cable

VEDA HCT User Manual

Across connection

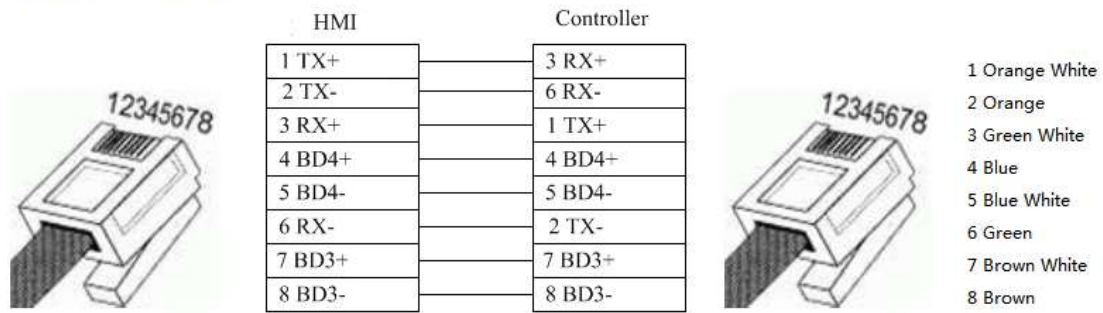

Direct connection

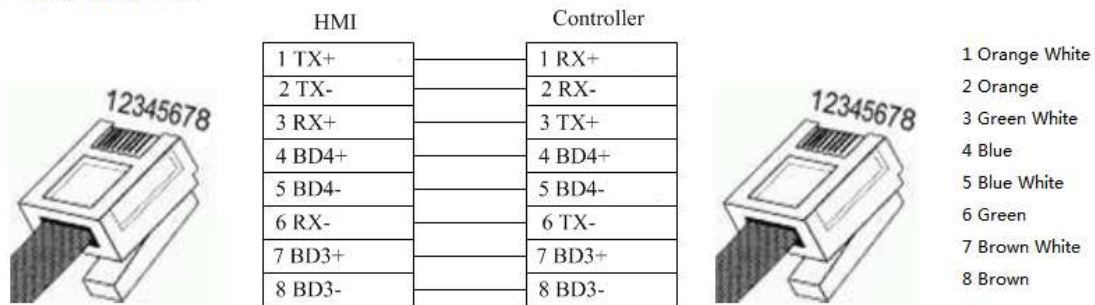

- Registers supported by TCP

Device	Bit Address	Word Address	Format	Notes
System internal/external output node	0X1-65535	---	DDDDD	
System internal/external input node	1X1-65535	---	DDDDD	
Analog input data register	---	3X1-65535	DDDDD	
Data register	---	4X1-65535	DDDDD	

5 Modbus_UDP

- Modbus UDP cable

Across connection

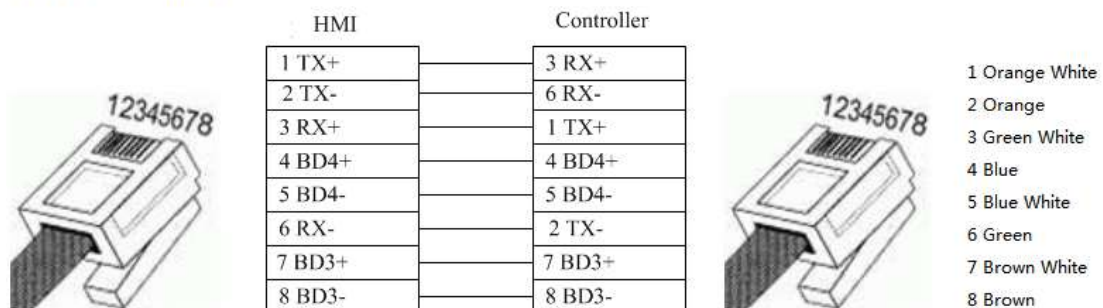

VEDA HCT User Manual

Direct connection

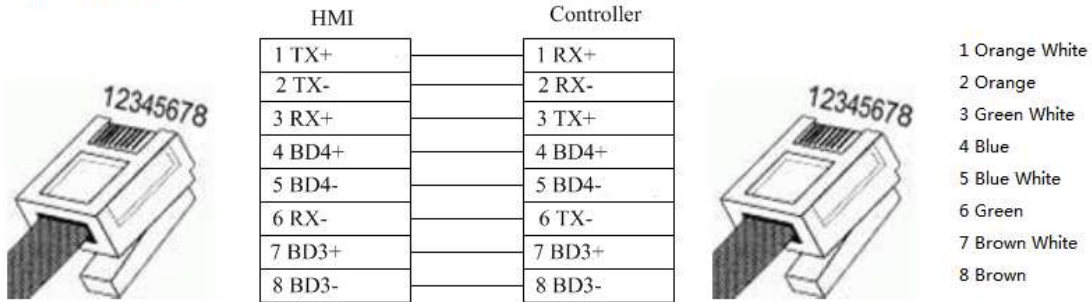

- Registers supported by Modbus UDP:

Device	Bit Address	Word Address	Format	Notes
System internal/external output node	0X1-65535	---	DDDDD	
System internal/external input node	1X1-65535	---	DDDDD	
Analog input data register	---	3X1-65535	DDDDD	
Data register	---	4X1-65535	DDDDD	

Modbus RTU Server - Serial port service

- Modbus RTU Server series RS232 cable

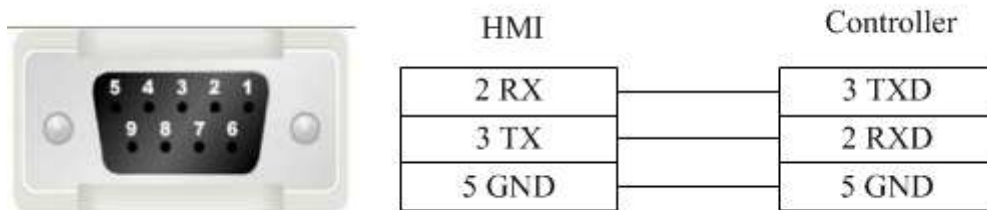

- Modbus RTU Server series RS485-2 cable

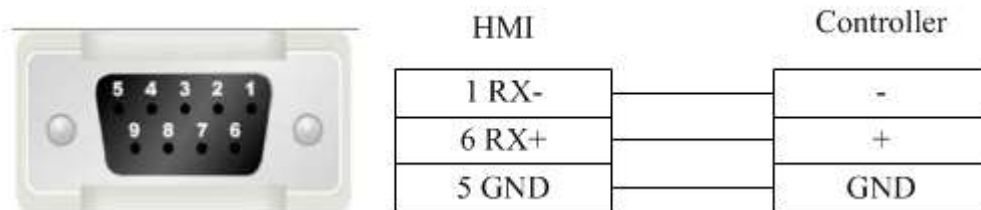

- Modbus RTU Server series RS485-4 cable

VEDA HCT User Manual

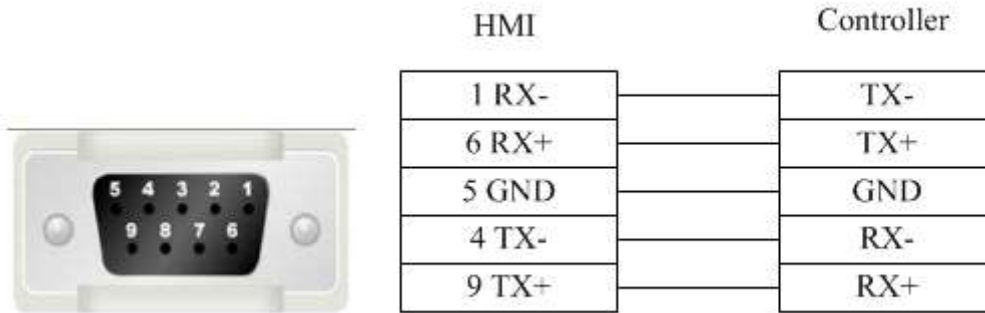

▪Registers supported by Modbus RTU Server:

Device	Bit Address	Word Address	Format	Notes
System internal/external output node	LB0-65535	---	DDDDD	LBn: 0X(n+1) n: 0-65535 Fox example: LB0 = 0X1
System internal/external input node	LB0-65535	---	DDDDD	LBn: 1X(n+1) n: 0-65535 Fox example: LB0 = 1X1
Analog input data relay	---	LW0-9998	DDDDD	LWn: 3X(n+1) n: 0-9998 Fox example: LW0 = 3X1
Analog input data relay	---	RW0-55535	DDDDD	RWn: 3X(n+10000) n: 0-55535 Fox example: RW0 = 3X10000
Data register	---	LW0-9998	DDDDD	LWn: 4X(n+1) n: 0-9998 Fox example: LW0 = 4X1
Data register	---	RW0-55535	DDDDD	RWn: 4X(n+10000) n: 0-55535 Fox example: RW0 = 4X10000

Modbus TCP Server– Ethernet service

▪Modbus TCP Server cable

Across connection

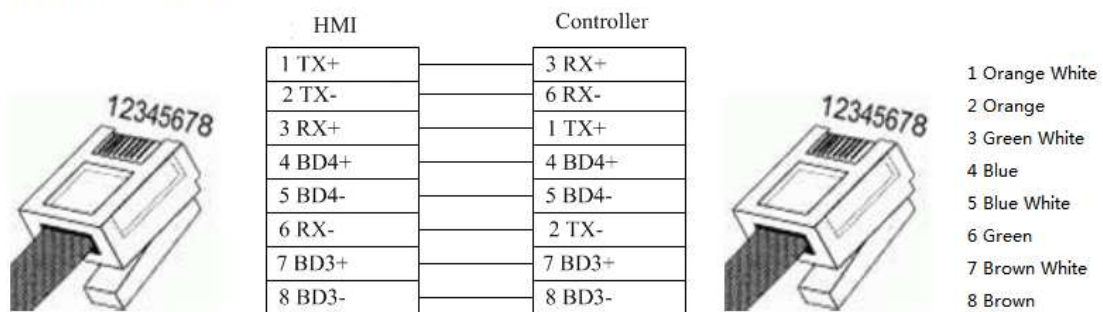

VEDA HCT User Manual

Direct connection

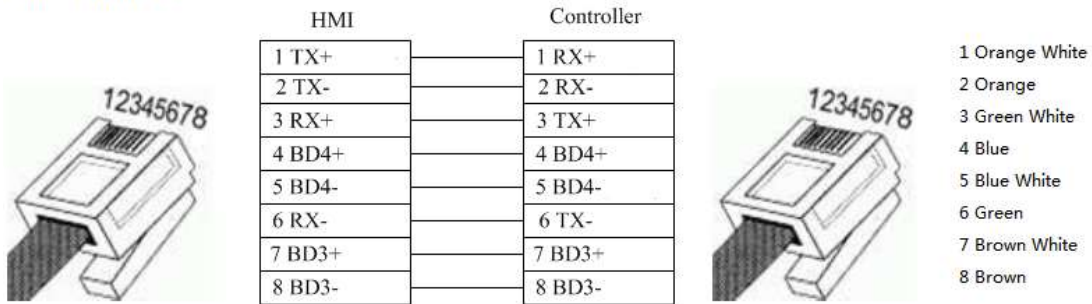

Registers supported by Modbus TCP Server

Device	Bit Address	Word Address	Format	Notes
System internal/external output node	LB0-65535	---	DDDDD	LBn: 0X(n+1) n: 0-65535 Fox example: LB0 = 0X1
System internal/external input node	LB0-65535	---	DDDDD	LBn: 1X(n+1) n: 0-65535 Fox example: LB0 = 1X1
Analog input data relay	---	LW0-9998	DDDDD	LWn: 3X(n+1) n: 0-9998 Fox example: LW0 = 3X1
Analog input data relay	---	RW0-55535	DDDDD	RWn: 3X(n+10000) n: 0-55535 Fox example: RW0 = 3X10000
Data register	---	LW0-9998	DDDDD	LWn: 4X(n+1) n: 0-9998 Fox example: LW0 = 4X1
Data register	---	RW0-55535	DDDDD	RWn: 4X(n+10000) n: 0-55535 Fox example: RW0 = 4X10000

OMRON

Omron CP1H_CP1L

- OMRON CP1H_CP1L series RS232 cable

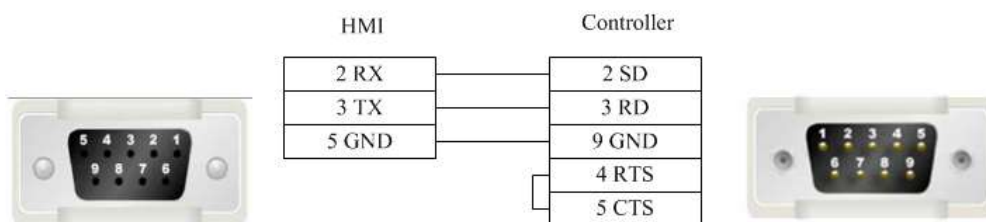

- OMRON CP1H_CP11 series (communication module) RS485-2 cable

VEDA HCT User Manual

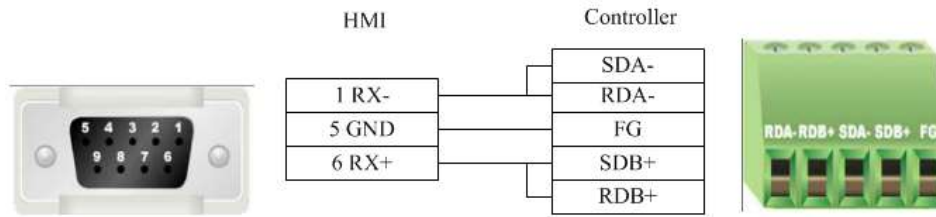

- OMRON CP1H_CP1L series RS485-4 cable

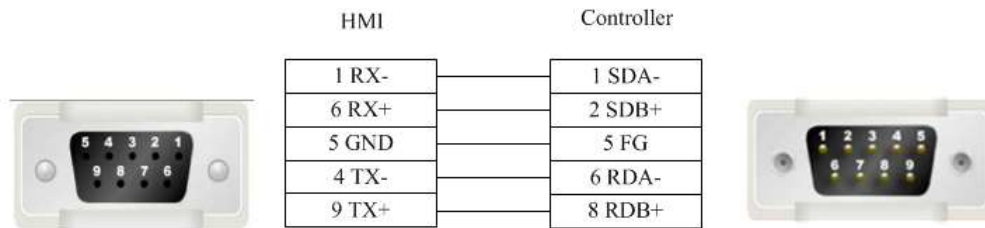

- OMRON CP1H_CP1L series (communication module) RS485-4 cable

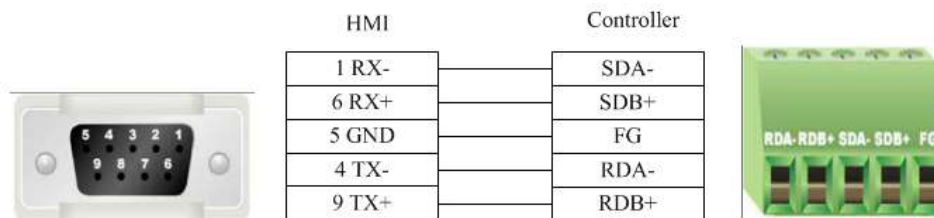

- Registers supported by OMRON CP1H_CP1L

Device	Bit Address	Word Address	Format	Notes
Work Relay	W_bit 0.0-8191.15	-----	DDDD.DD	
Hold Relay	H_bit 0.0-24576.15	-----	DDDDD.DD	
Data Relay	D_bit 0.0-524288.15	-----	DDDDDD.DD	
Counter Relay	C_bit 0.0-65535.15	-----	DDDDD.DD	
Timer Relay	T_bit 0.0-65535.15	-----	DDDDD.DD	
Auxiliary Relay	A_bit 0.0-15360.15	-----	DDDDD.DD	
Channel I/O	CIO_bit 0.0-98304.15	-----	DDDDD.DD	
Work Register	-----	W_word 0-511	DDD	
Hold Register	-----	H_word 0-1535	DDDD	
Data Register	-----	D_word 0-32767	DDDDD	
Counter Register	-----	C_word 0-4095	DDDD	
Timer Register	-----	T_word 0-4095	DDDD	
Auxiliary Register	-----	A_word 0-959	DDD	
Channel I/O Register	-----	CIO_word 0-6143	DDDD	

VEDA HCT User Manual

- Panasonic FP series RS232 cable

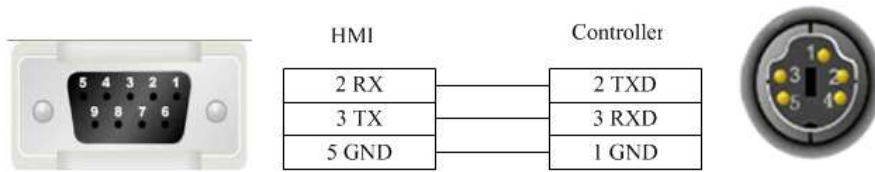

- Panasonic FP series CPU terminal RS232 cable

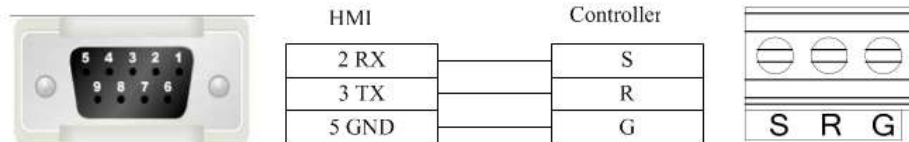

- Panasonic FP series communication card RS232 cable.

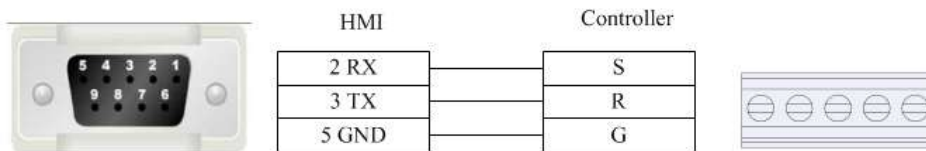

- Panasonic FP2/3 series RS232 cable

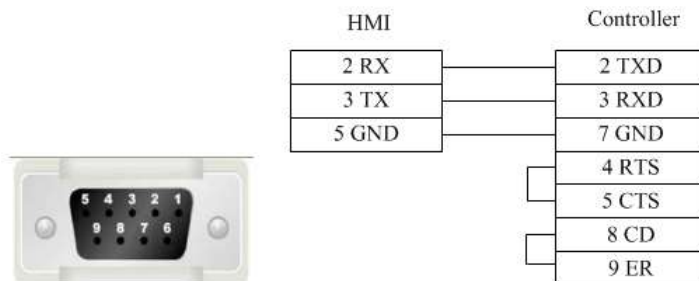

- Panasonic FP series RS485-2 cable

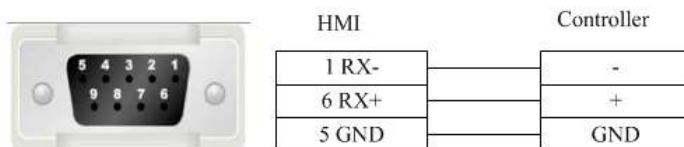

- Panasonic FP3 series RS485-4 programming port cable

VEDA HCT User Manual

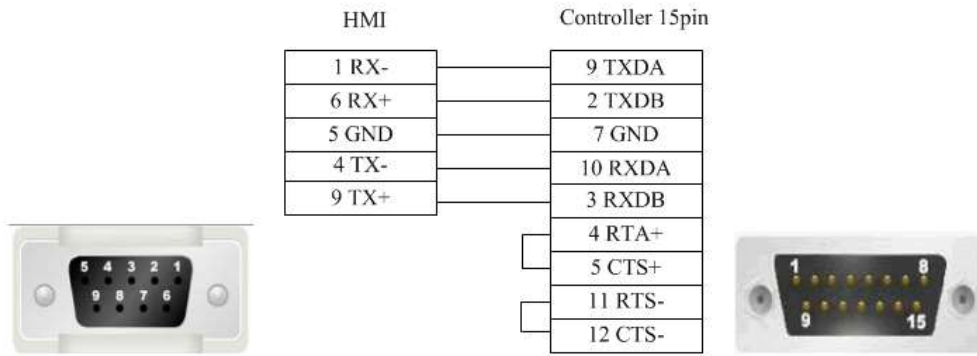

- Panasonic FP series (other modules) RS485-4 cable

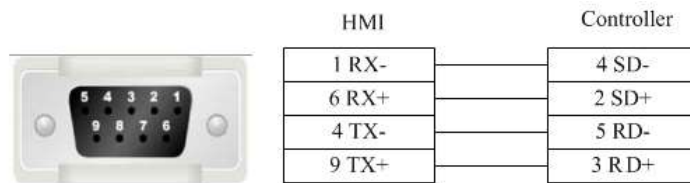

- Registers supported by Panasonic FP0/FPX:

Device	Bit Address	Word Address	Format	Notes
External output node	Y0-9999.F	---	DDDD.H	
External input node	X0-9999.F	---	DDDD.H	
Timer bit	T0-9999	---	DDDD	
Counter bit	C0-9999	---	DDDD	
Link auxiliary node	L0-9999.F	---	DDDD.H	
Internal auxiliary node	R0-9999.F	---	DDDD.H	
T/C current value	---	EVO-65535	DDDDD	
T/C set value	---	SV0-9999	DDDD	
Data register	---	DT0-99999	DDDDD	
Output register	---	WY0-32767	DDDDD	
Input register	---	WX0-32767	DDDDD	
Internal auxiliary register	---	WR0-32767	DDDDD	
Link data register	---	LD0-99999	DDDDD	
Link register	---	WL0-32767	DDDDD	
File register	---	FL0-99999	DDDDD	

Siemens

1 Siemens S7_200

VEDA HCT User Manual

- Siemens S7-200 series RS232 cable

Siemens serial port programming cable is used to communicate with HMI device.

- Siemens S7-200 series RS485-2 cable

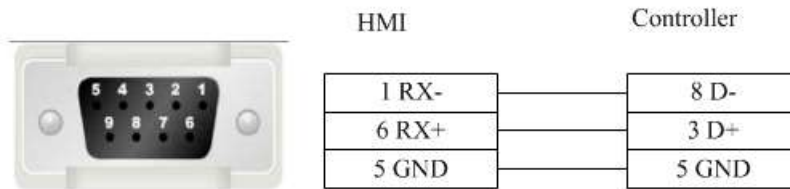

- Registers supported by Siemens S7-200

Device	Bit Address	Word Address	Format	Notes
Digital output and Peripheral image register node	Q.B0.0-127.7	---	DDD.O	
Internal memory bit	M.B0.0-255.7	---	DDD.O	
Digital input and Peripheral image register node	I.B0.0-127.7	---	DDD.O	
Special memory bit	SM.B0.0-4399.7	---	DDDD.O	
Variable memory node	V.B0.0-81919.7	---	DDDDD.O	
Timer bit	Tim0-255	---	DDD	
Counter bit	Cnt0-255	---	DDD	
SCR node	S.B0.0-255.7	---	DDD.O	
Digital output and Peripheral image register	---	QW0-14	DD	
Digital output and Peripheral image register (32 bit)	---	QD0-12	DD	
Digital input and Peripheral image register	---	IW0-14	DD	
Digital input and Peripheral image register (32 bit)	---	ID0-12	DD	
Internal memory	---	MW0-30	DD	
Internal memory (32 bit)	---	MD0-28	DD	
Analog output	---	AQW0-62	DD	
Analog input	---	AIW0-62	DD	
SCR	---	SW0-30	DD	
SCR (32 bit)	---	SD0-28	DD	
Special memory register	---	SMW0-548	DDD	
Special memory register (32 bit)	---	SMD0-546	DDD	
Variable memory	---	VW0-10238	DDDDD	
Variable memory (32 bit)	---	VD0-10236	DDDDD	
Timer current value	---	Tim0-255	DDD	
Counter current value	---	Cnt0-255	DDD	

2 Siemens S7_200 Network

- Siemens S7-200 Network Cable

VEDA HCT User Manual

Across connection

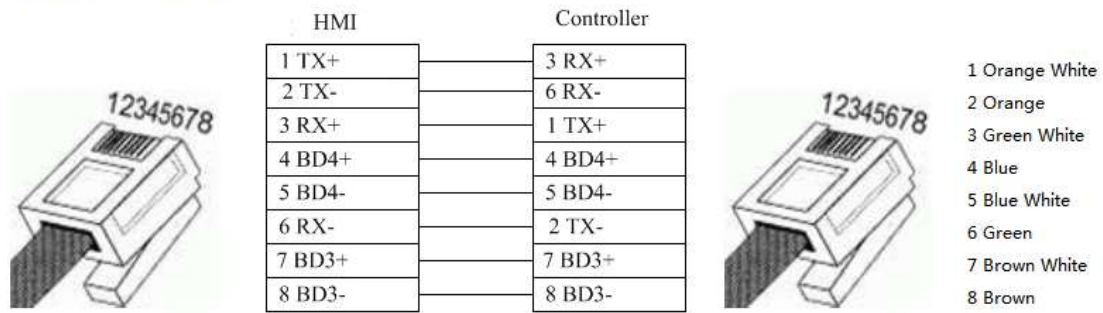

Direct connection

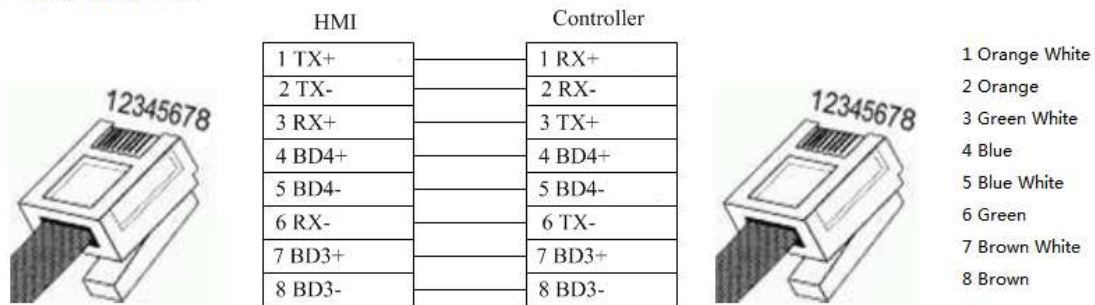

- Registers supported by siemens S7-200 Network:

Device	Bit Address	Word Address	Format	Notes
Digital output and Peripheral image register node	Q.B0.0-127.7	---	DDD.O	
Internal memory bit	M.B0.0-255.7	---	DDD.O	
Digital input and Peripheral image register node	I.B0.0-127.7	---	DDD.O	
Variable memory node	V.B0.0-65535.7	---	DDDDD.O	
Digital output and Peripheral image register	---	QW0-14	DD	
Digital output and Peripheral image register (32 bit)	---	QD0-12	DD	
Digital input and Peripheral image register	---	IW0-14	DD	
Digital input and Peripheral image register (32 bit)	---	ID0-12	DD	
Internal memory	---	MW0-30	DD	
Internal memory (32 bit)	---	MD0-28	DD	
Variable memory	---	VW0-8190	DDDDD	
Variable memory (32 bit)	---	VD0-8188	DDDDD	

3 Siemens S7_200 Network Module

- Siemens S7-200 Network Module cable

VEDA HCT User Manual

Across connection

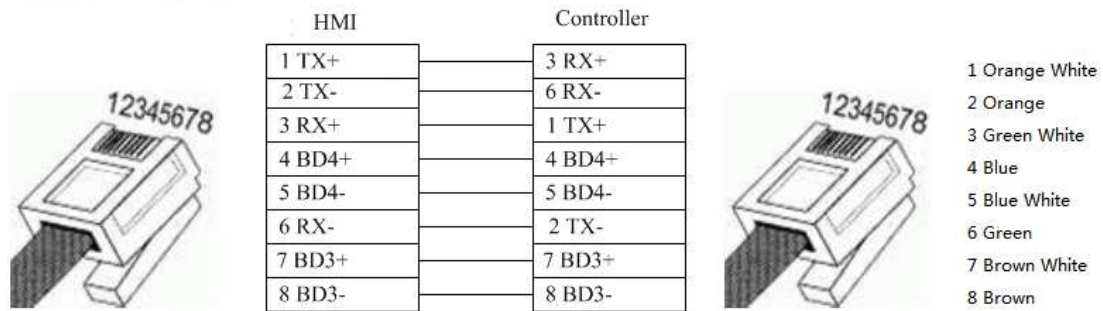

Direct connection

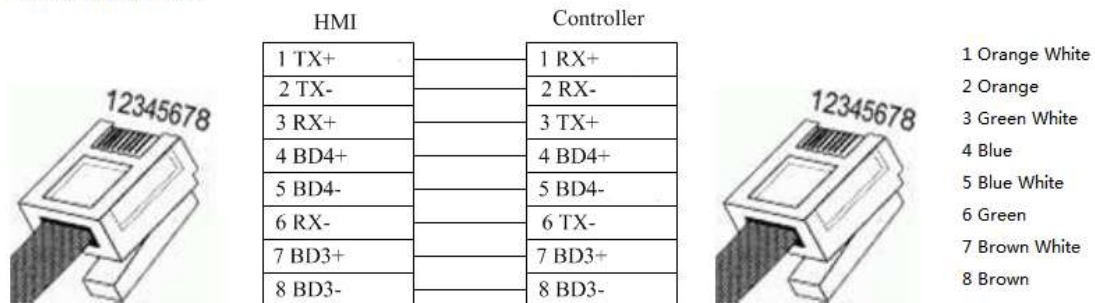

Registers supported by Siemens S7-200 Network Module

Device	Bit Address	Word Address	Format	Notes
Digital output and Peripheral image register node	Q.B0.0-127.7	---	DDD.O	
Internal memory bit	M.B0.0-255.7	---	DDD.O	
Digital input and Peripheral image register node	I.B0.0-127.7	---	DDD.O	
Variable memory node	V.B0.0-65535.7	---	DDDDD.O	
Digital output and Peripheral image register	---	QW0-14	DD	
Digital output and Peripheral image register (32 bit)	---	QD0-12	DD	
Digital input and Peripheral image register	---	IW0-14	DD	
Digital input and Peripheral image register (32 bit)	---	ID0-12	DD	
Internal memory	---	MW0-30	DD	
Internal memory (32 bit)	---	MD0-28	DD	
Variable memory	---	VW0-8190	DDDD	
Variable memory (32 bit)	---	VD0-8188	DDDD	

4 Siemens S7_300 MPI

- Siemens S7-300 MPI series RS232 cable
SIEMENS serial port programming cable is used to communicate with HMI device.
- Siemens S7-300 MPI series RS485-2 cable

VEDA HCT User Manual

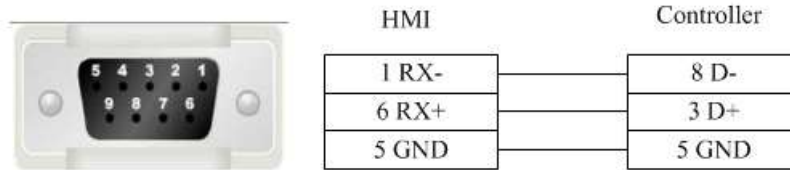

Registers supported by Siemens S7-300 MPI

Device	Bit Address	Word Address	Format	Notes
External output node	Q.B0.0-511.7	---	DDD.O	
External input node	I.B0.0-511.7	---	DDD.O	
Internal auxiliary node	M.B0.0-4095.7	---	DDDD.O	
Data register node	DBn_DBX0.0-9999.7	---	DDDD.O	The main address can be set during the hardware configuration.
External output register	---	QW0-126	DDD	
External output register (32 bit)	---	QD0-124	DDD	
External input register	---	IW0-126	DDD	
External input register (32 bit)	---	ID0-124	DDD	
Internal register	---	MW0-2046	DDDD	
Internal register (32 bit)	---	MD0-2044	DDDD	
Data register	---	DBn_DBW0-65534	DDDDD	The main address can be set during the hardware configuration.
Data register (32 bit)	---	DBn_DBD0-65532	DDDDD	The main address can be set during the hardware configuration.

5 Siemens S7_300_network

Siemens S7-300 Network cable

Across connection

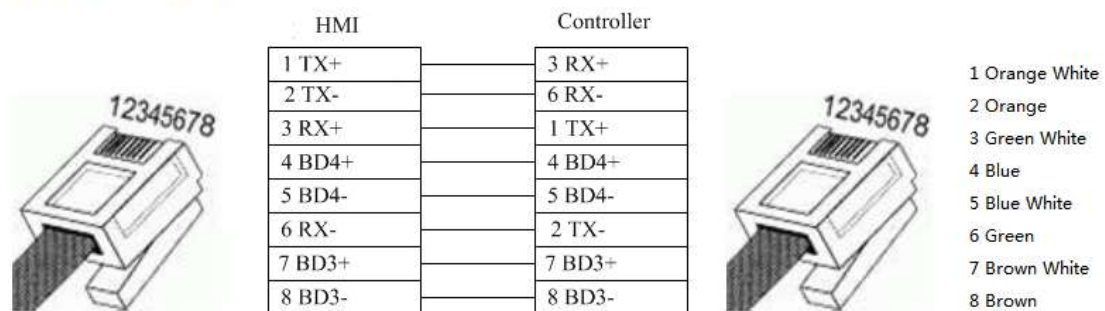

VEDA HCT User Manual

Direct connection

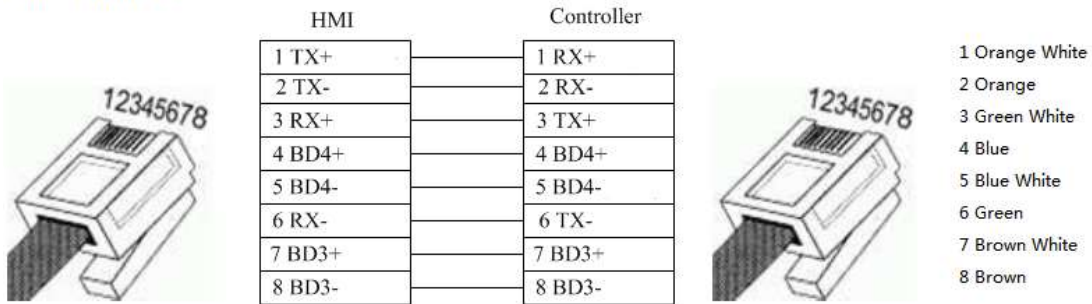

▪ Registers supported by S7-300 Network

Device	Bit Address	Word Address	Format	Notes
External output node	Q.B0.0-2047.7	---	DDDD.O	
External input node	I.B0.0-2047.7	---	DDDD.O	
Data register node	DBn_DBX0.0-9999.7	---	DDDD.O	The main address can be set during the hardware configuration.
External output register	---	QW0-2046	DDDD	
External output register (32 bit)	---	QD0-2044	DDDD	
External input register	---	IW0-2046	DDDD	
External input register (32 bit)	---	ID0-2044	DDDD	
Internal register	---	MW0-2046	DDDD	
Internal register (32 bit)	---	MD0-2044	DDDD	
Data register	---	DBn_DBW0-65534	DDDDD	The main address can be set during the hardware configuration.
Data register (32 bit)	---	DBn_DBD0-65532	DDDDD	The main address can be set during the hardware configuration.

6 Siemens S7_1200_network

- Siemens S7-1200 Network cable

VEDA HCT User Manual

Across connection

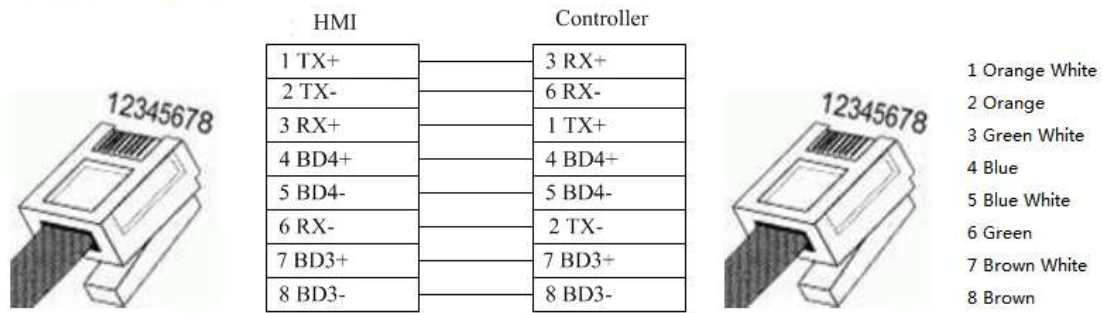

Direct connection

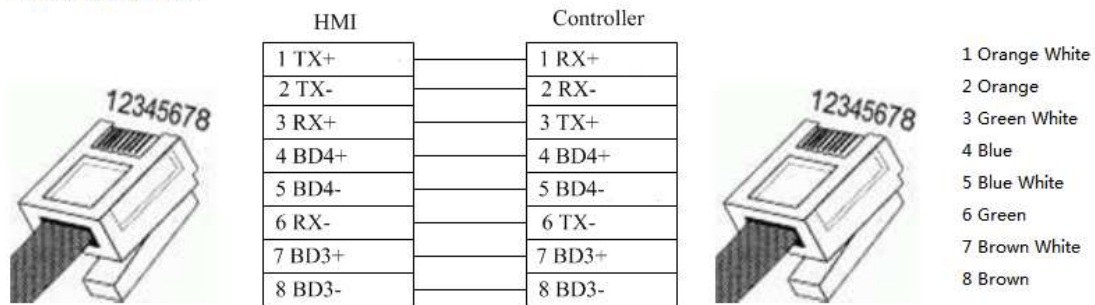

Registers supported by S7-1200

Device	Bit Address	Word Address	Format	Notes
External output node	Q.B0.0-127.7	---	DDD.O	
External input node	I.B0.0-127.7	---	DDD.O	
Internal auxiliary node	M.B0.0-2047.7	---	DDDD.O	
Data register node	DBn_DBX0.0-65535.7	---	DDDDD.O	The main address can be set during the hardware configuration.
External output register	---	QW0-126	DDD	
External output register (32 bit)	---	QD0-124	DDD	
External input register	---	IW0-126	DDD	
External input register (32 bit)	---	ID0-124	DDD	
Internal register	---	MW0-2046	DDDD	
Internal register (32 bit)	---	MD0-2044	DDDD	
Data register	---	DBn_DBW0-65534	DDDDD	The main address can be set during the hardware configuration.
Data register (32 bit)	---	DBn_DBD0-65532	DDDDD	The main address can be set during the hardware configuration.

VEDA HCT User Manual

THINGET

- THINGET Controller series RS232 cable

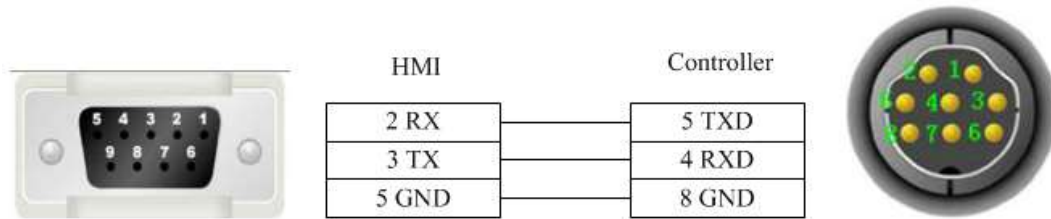

- THINGET Controller Series RS485-2 cable

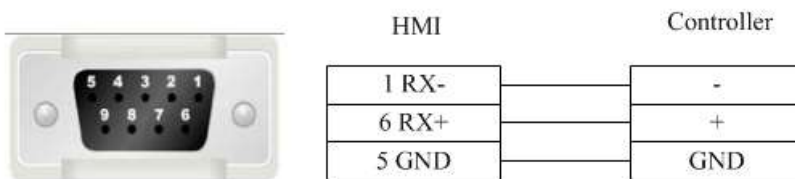

- Registers supported by THINGET Controller:

Device	Bit Address	Word Address	Format	Notes
Status node	S0-99999	---	DDDDD	
Counter node	C0-99999	---	DDDDD	
Timer node	T0-99999	---	DDDDD	
Inter relay node	M0-99999	---	DDDDD	
Output relay node	Y0.0-303237.7	---	000000.0	
Input relay node	X0.0-303237.7	---	000000.0	
FlashROM register	---	FD0-9999	DDDD	
Data register	---	D0-9999	DDDD	
Timer	---	TD0-9999	DDDD	
Counter	---	CD0-9999	DDDD	

TRIO

1 TRIO _modbus

- TRIO_modbus series RS232 cables

VEDA HCT User Manual

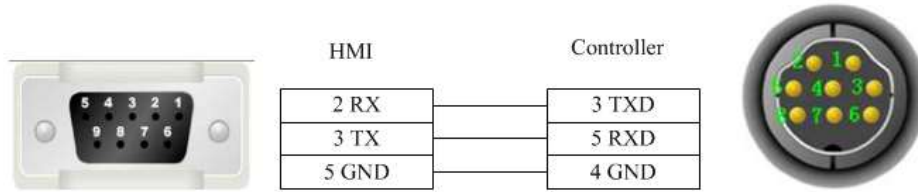

- TRIO_modbus series RS485-4 cable

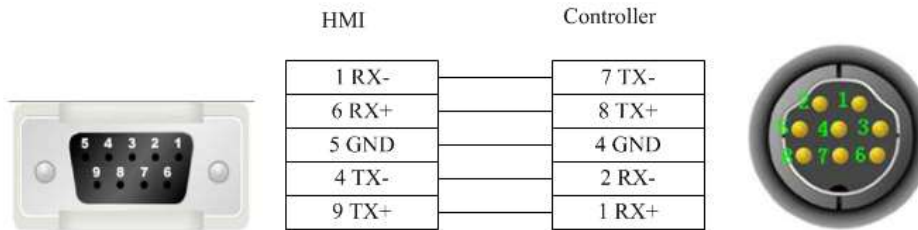

- Registers supported by TRIO_modbus

Device	Bit Address	Word Address	Format	Notes
System internal/external output node	0X1-65535	---	DDDDD	
System internal/external input node	1X1-65535	---	DDDDD	
Analog input data register	---	3X1-65535	DDDDD	
Data register	---	4X1-65535	DDDDD	

2 TRIO_modbus_extend

- TRIO_modbus_extend series RS232 cable



- TRIO_modbus_extend series RS485-4 cable

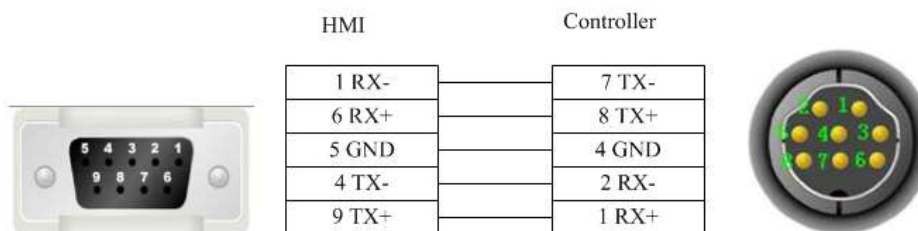

- Registers supported by TRIO_modbus_extend

VEDA HCT User Manual

Device	Bit Address	Word Address	Format	Notes
System internal/external output node	0X1-65535	---	DDDDD	
System internal/external input node	1X1-65535	---	DDDDD	
Analog input data bit	3X_BIT1.0-65535.15	---	DDDDD.DD	
Data register bit	4X_BIT1.0-65535.15	---	DDDDD.DD	
Analog input data register	---	3X1-65535	DDDDD	
Data register	---	4X1-65535	DDDDD	
Data register	---	5X1-65535	DDDDD	
Data register	---	6X1-65535	DDDDD	
Data register	---	3X-DINV1-65535	DDDDD	
Data register	---	4X-DINV1-65535	DDDDD	

3 Differences between TRIO _modbus and TRIO _modbus_extend

Many data memory such as analog input data bit, data register bit and data register are added into TRIO_modbus_extend on the base of TRIO_modbus.

Yaskawa

1 Yaskawa

- Yaskawa MP Series SIO (Extension) cable

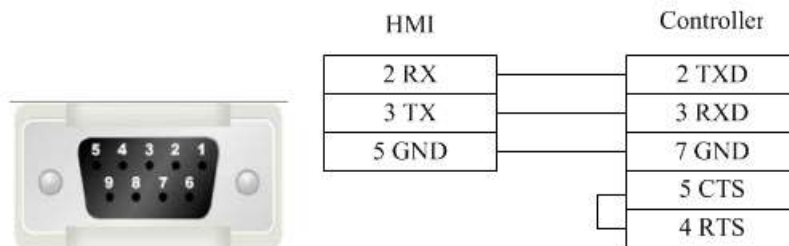

- Registers supported by Yaskawa MP Series SIO (Extension):

Device	Bit Address	Word Address	Format	Notes
Coil	MB0.0-65534.F	---	DDDDD.H	
Inputrelay	IB0.0-FFFF.F	---	HHHH.H	
Hold register	---	MW0-65534	DDDDD	
Input register	---	IW0-FFFF	HHHH	

2 Yaskawa network device

- Yaskawa UDP Slave cable

VEDA HCT User Manual

Across connection

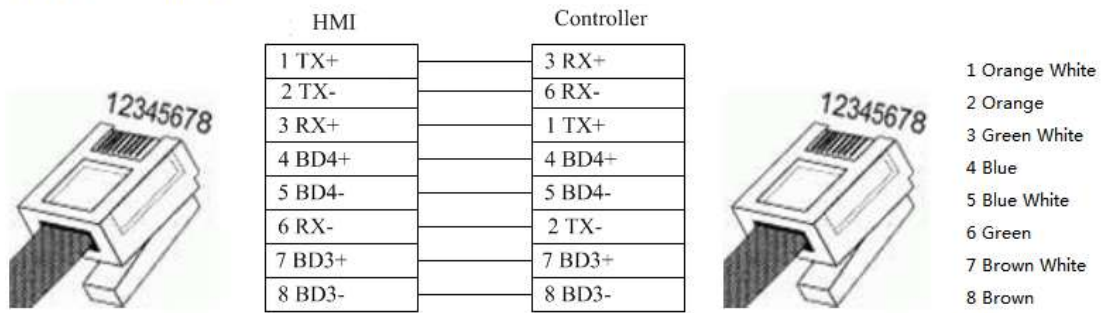

Direct connection

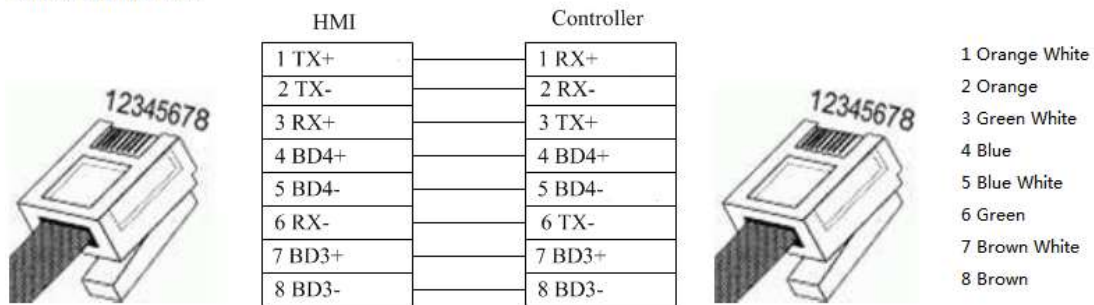

- Registers supported by Yaskawa UDP slave:

Device	Bit Address	Word Address	Format	Notes
Coil	MB0.0-65534.F	---	DDDDD.H	
Inputrelay	IB0.0-FFFF.F	---	HHHH.H	
Output relay	QB0.0-FFFF.F	---	HHHH.H	
Hold register	---	MW0-65534	DDDDD	
Inputregister	---	IW0-FFFF	HHHH	
Output register	---	QW0-FFFF	HHHH	
Hold register	---	ML0-65534	DDDDD	

Yokogawa

- Yokogawa FA-M3 series RS232 cable
Yokogawa serial port programming cable is used to communicate with the HMI device.
- Yokogawa FA-M3 series RS232 cable

VEDA HCT User Manual

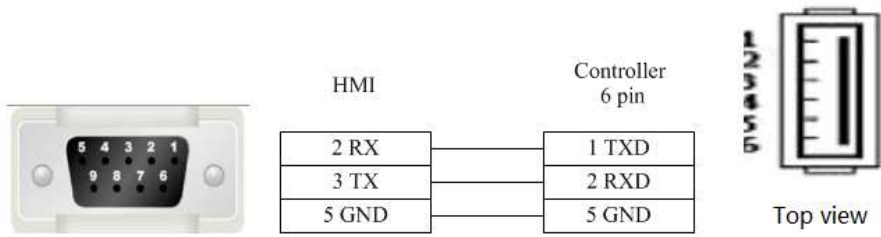

- Yokogawa FA-M3 series RS485-4 cable

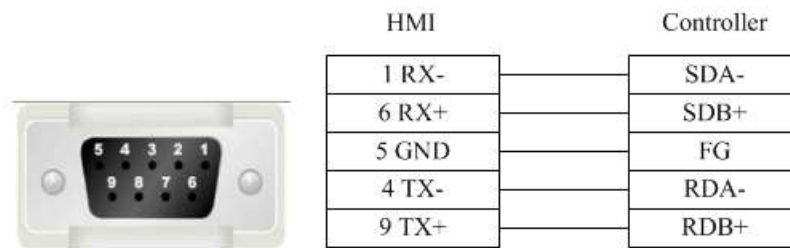

- Yokogawa FA-M3 series RS4852 cable

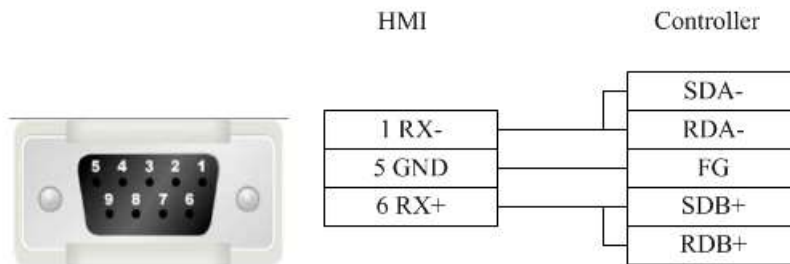

- Registers supported by Yokogawa FA-M3:

Device	Bit Address	Word Address	Format	Notes
Input Relay	X1-65535	---	DDDDD	
Output Relay	Y1-65535	---	DDDDD	
Internal Relay	I1-65535	---	DDDDD	
Special Relay	M1-65535	---	DDDDD	
Link Relay	L1-65535	----	DDDDD	
Data Register	---	D_word1-65535	DDDDD	
File Register	---	B_word1-65535	DDDDD	
Index Register	----	V_word1-65535	DDDDD	
Link Register	---	W_word1-65535	DDDDD	
Special Register	---	Z_Word1-65535	DDDDD	

VEDA HCT User Manual

4 Detailed manual

4.1 File

1 Save Project

Shortcut key: <Ctrl>+<S>. Save the project being edited.

2 Close Project

Close the current project without exiting the software, usually used for switching among projects.

3 Save Project As

Use a new path or new name to save the current project (without deleting the previous project).

4 Project Used Recently

Display the paths of no more than 10 projects opened recently and each one can be directly opened by clicking.

5 Open Project

Shortcut key: <Ctrl>+<O>. It is used to open an existing project other than any project repeatedly.

After the software is opened, any project with the file suffix name “*.fspj” can be opened by clicking it on the project name.

Remark: if the software is correctly installed, the user can directly open the project by clicking the corresponding file with the postfix *.fspj in the Windows Explorer.

6 Create New Project

Shortcut key: <Ctrl>+<N>. It is used to create a new project.

After the project is correctly created, a file folder with the same name will be created to save the project files related.

VEDA HCT User Manual

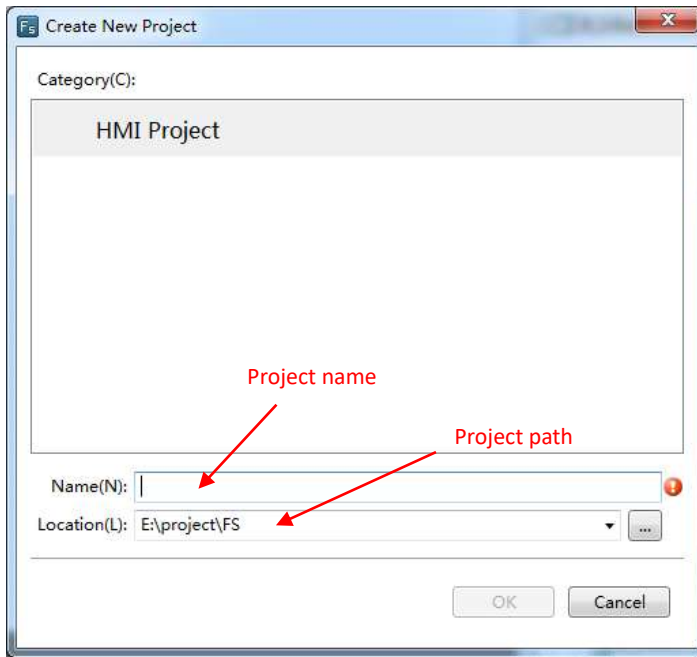

Please refer to the “First Use” for the following settings.

7 Transform Project

Convert project from software FD2000 into the current software version. But only the picture name and the text can be converted, and other parameters must be reset.

8 Exit

Shortcut key: <Alt>+<X>. It is used to close the project and exit the software.

4.2 View

1 Outline

Open/close the outline view, and list all available components on the current window. One or all components can be quickly hidden or locked.

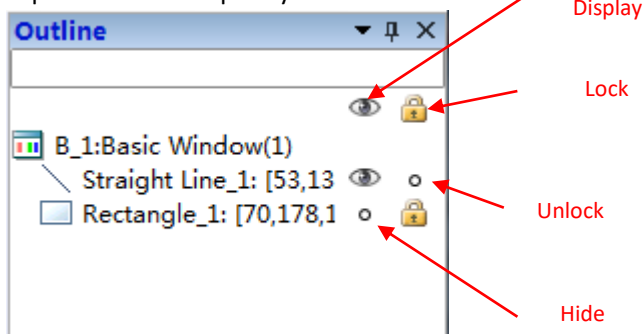

2 Project

Open/close project view which the tree structure facilitates the operation such as “HMI setting”, “window”, “communication connection”, “system setting”, “library”, “macro”, and “prescription”, and so on. Details can be seen in [Detailed manual /Setup](#).

VEDA HCT User Manual

3 Current language

Select the current displaying language and the checked language is the current displaying language.

Note: the language refers to the content edited well by the current project other than translated by the system automatically!

4 Current Status

The checked Status is the current status. It is used to display the components displaying effect quickly in different status.

5 Find and Replace

Open/close the Find and Replace view, used to search or replace any word address, bit address used in the current project.

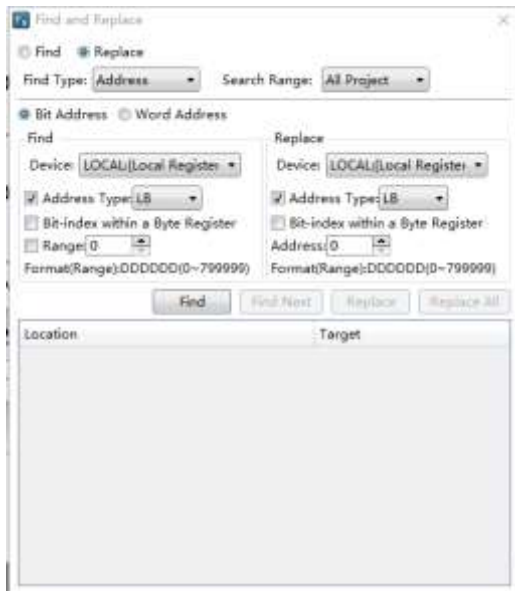

6 Restore to the Default View

Restore to the Default View– readjust the view arrangement of the software and restore the default arrangement.

7 Window

Open/close the window view and use the tree structure facilitates modifying the Power-on Screen, Public Window, Basic Window, Keyboard Window and System Window.

① Power-on Screen

It is the window displayed at startup. Any picture expected to be used by the user, such as the company Logo, can be displayed. But it will disappear after a while before entering the configuration screen. The picture formats supported are BMP, JPG, GIF and PNG.

VEDA HCT User Manual

② Common window

The common window always exists and all common window attributes are effective no matter the configuration screen is on a basic window or a pop-up window. The general effective components such as t macro and timer can be set in this window.

③ Drop-down Window

The Drop-down Window can be operated to edit the content of the drop down list when the configuration screen is running. But this function is only effective for a capacitor screen.

④ Basic Window

The attribute of basic window can be viewed or modified here. The window of number 29001~29006 is provided to log on with the user's authority for the user. It can be directly used in the software.

⑤ Create Basic Window

A new basic window can be created by clicking "Create Basic Window" in the software picture. The window name, size and other attributes need to be set. The new basic window can also be created in the default attributes.

⑥ Keyboard Window

The keyboard window attributes can be viewed or modified after clicking here. And a customized keyboard can be created which used in the software.

⑦ System window

The system window can be viewed (it can also be modified under direction) after clicking here, for example, the system window of "communication information".

8 Output

Open/close the output view. The compiling information can be output and displayed here.

9 Error

Open/close the error view. All errors collected during compiling are recorded here.

4.3 Edit

1 Cancel

Cancel the operation and go back to the previous one.

2 Recovery

Recover the last action cancelled.

VEDA HCT User Manual

3 Find/Replace

Set the designated searching range and search the bit address/ word address or replace with a new bit address/ word address/.

4 Cut

Cut away the selected component and temporarily save it on the clipboard.

5 Copy

Copy the selected component and temporarily save it on the clipboard

6 Multi-Copy

Set the copy range, quantity, interval and direction, and make the addresses change in any rule to obtain more components (many components can be copied and pasted integrally, and the addresses will change orderly).

7 Paste

Paste the content of the clipboard onto the project.

8 Delete

Delete the selected components from the project.

9 Inching

Move left/right/up/down for one unit.

10 Alignment

It is effective only when many components are selected. It is used to align these components on the left, on the vertical middle line, on the right, on the up, on the horizontal middle line, or on the bottom.

11 Size

It is effective only when many components are selected. It is used to set these components to the same width, height or same size.

12 Layer

It is effective only when the component is selected. It is used to set the component to the top, to the bottom, to the previous layer, to the next layer, or set many components in the same horizontal space or in the same vertical space.

13 Same Color

It is effective only when many components are selected. It is used to set all components in the same color.

14 Group

Integrate many components.

15 Ungroup

Make the components of group to restore into individuals.

VEDA HCT User Manual

16 Center horizontally

Center all selected components horizontally in the window.

17 Center vertically

Center all selected components vertically in the window.

18 Lock

Lock the position of the component and stop it from size adjusting or position adjusting.

19 Unlock

Unlock a locked component and restore it to the state that its size or position can be adjusted.

4.4 Window

1 Create New Window

Create a new window and allow the user to set the window number, width, height and any other basic attribute or function.

2 Delete Window

Delete the selected window

3 Current Window Properties

Set the current window attributes and allow the user to set the window number, width, height and any other basic attribute or function.

① Basic

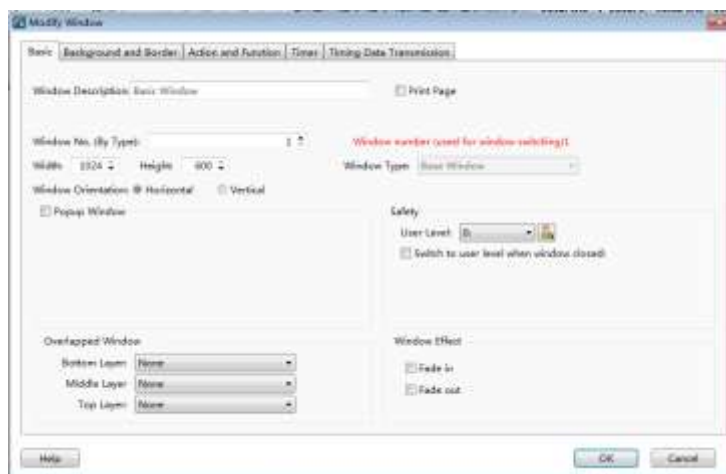

② Background and Border

VEDA HCT User Manual

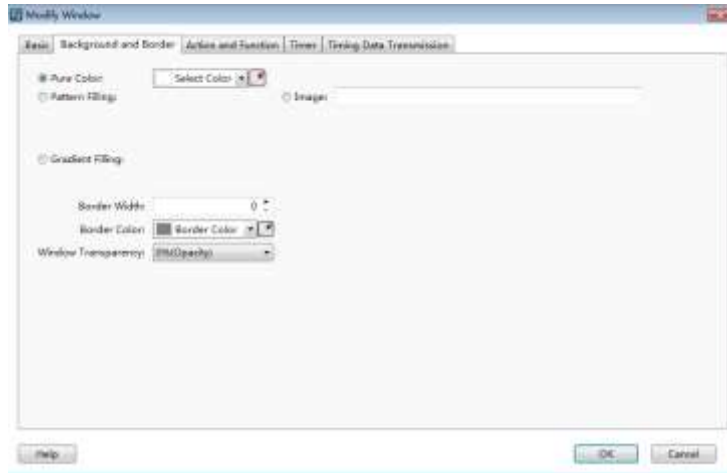

③ Action and Function

The action to open or close a window can be used to activate a bit, a word, a macro command or switch among windows.

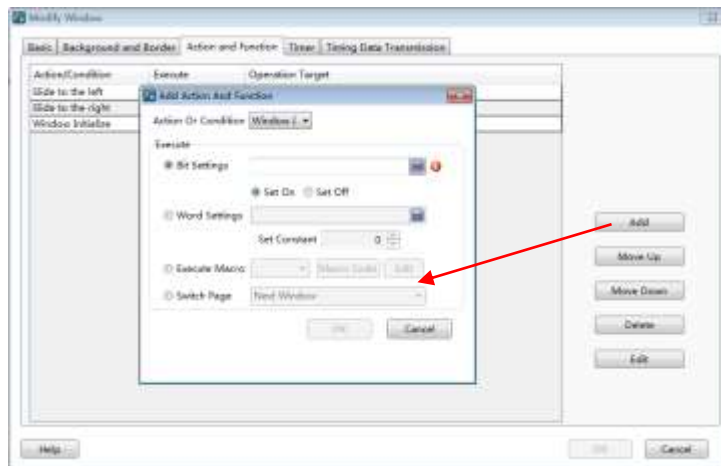

④ Timer

It is used to set an executing cycle. You can execute a macro or directly set a word or a bit according to the trigger conditions.

VEDA HCT User Manual

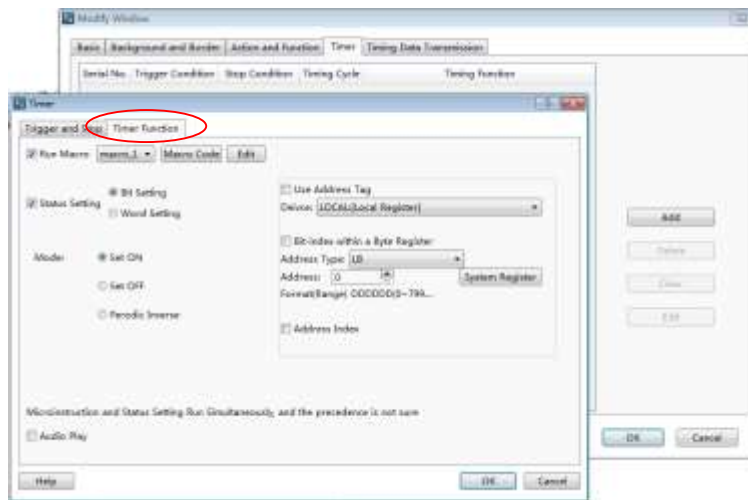
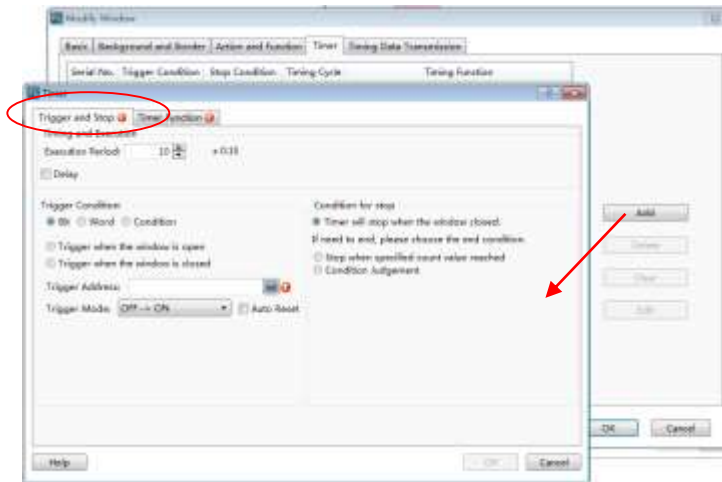

⑤ Timer Data Transmission

It is used to transmit words or bits in batches. And an action can be set before or after write-in.

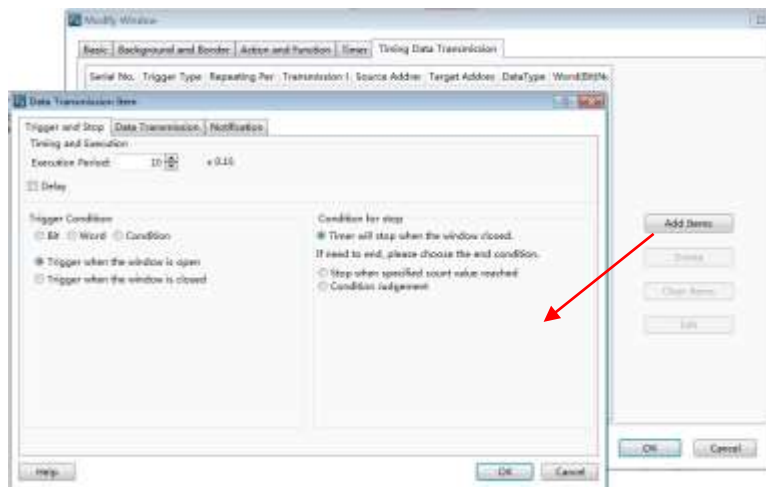

VEDA HCT User Manual

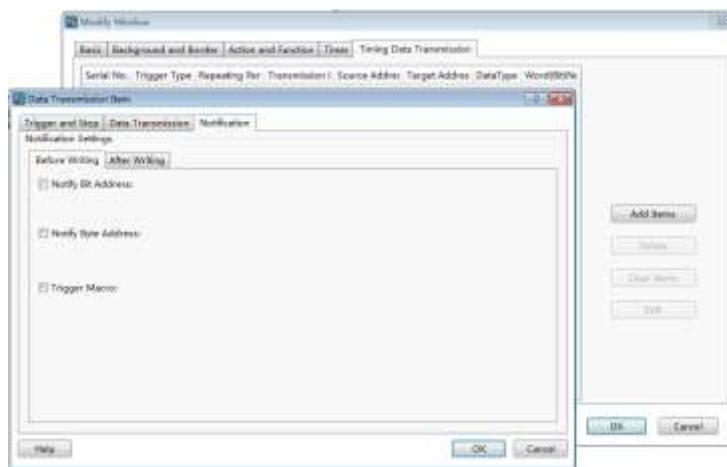
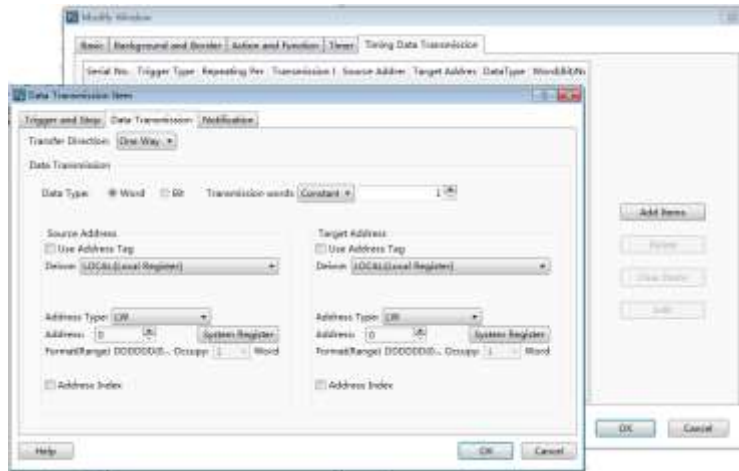

4 Edit Starting LOGO Window

The user can set the properties of the Power-on Screen window (double click the window after open the Power-on Screen)

5 Show the Public Window

Display/hide the Public Window and facilitate the user to view the effect of the Public Window displayed/hidden in the Basic Window.

6 Show the Lower Layer Window

Display/hide the lower layer window (the three lower layer windows are effective at the same time) and facilitate the user to view the effect of lower layer window displayed/hidden in the basic window.

7 Jump to the Target Window

When the selected component is integrated with a paging function, it is used to jump to the target screen window.

8 Show Grid

VEDA HCT User Manual

Display the grid and facilitate the user to view the position of components.

9 Grid alignment

Facilitate components aligning by the grid alignment function.

10 Align to alignment line

Activate the function of aligning the components in a line.

11 Grid Setting

Pop up the Grid Setting window. The user can customize the grid color and space here.

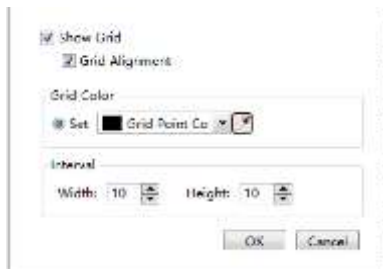

12 Window Zoom

Resize the window in a proportion including 50%, 75%, 100%, 125%, 150%, 175%, or 200%.

4.5 Drawing

4.5.1 Straight Line

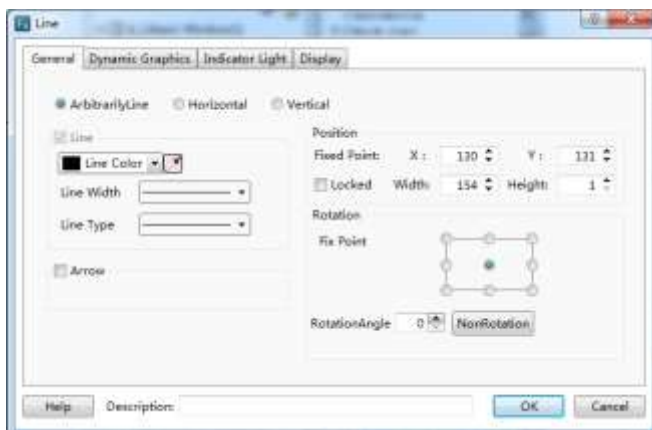

① General

- Arbitrarily Line

The user can draw a straight line at will.

- Horizontal

Rotate the straight line drawn by the user to the horizontal position around the center point.

VEDA HCT User Manual

- Vertical

Rotate the straight line drawn by the user to the vertical position around the center point.

- Line

See [Detailed manual/General functions/Drawing/Bordersettings](#).

- Arrow

The user can set the arrow pattern in the combo box, see the figure below.

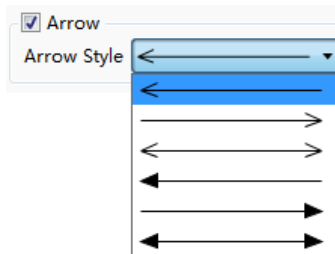

- Position

See [Detailed manual/General functions/Drawing/Position](#).

- Rotate

See [Detailed manual/General functions/Drawing/Rotation](#).

② Dynamic Graphics

See [Detailed manual/General functions/Drawing/Dynamic Graphics](#) for the details.

③ Indicator Light

See [Detailed manual/Component/Indicator Light](#) for the details.

④ Display

See [Detailed manual/General functions/Drawing/Display](#) for the details.

4.5.2 Fold Line

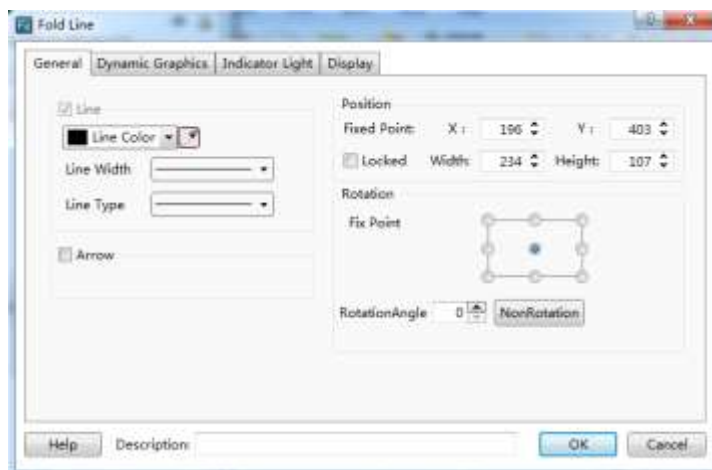

VEDA HCT User Manual

Click the left key to fix the fold line point in drawing. And click the right key to finish drawing. See details in: [Detailed Manual/ Drawing/ Straight Line](#).

4.5.3 Rectangle

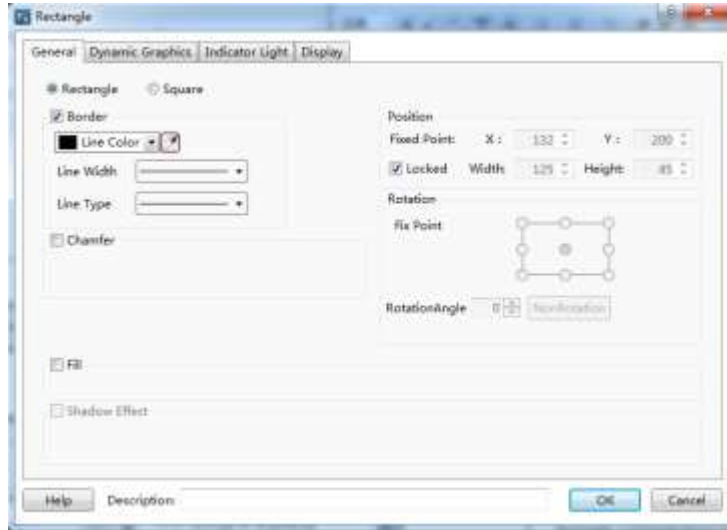

① General

- Rectangle

A rectangle is set to be drawn by the user.

- Square

Make the rectangle width equal to its length, and thus it is set into a square.

- Border

See [Detailed manual/General functions/Drawing/Border settings](#).

- Chamfer

After it is checked, edges of the rectangle drawn by the user can be chamfered in Line type (as shown in Fig. a) or in Fillet type (as shown in Fig. b). The maximum chamfering length cannot be larger than 1/2 of the shortest side length.

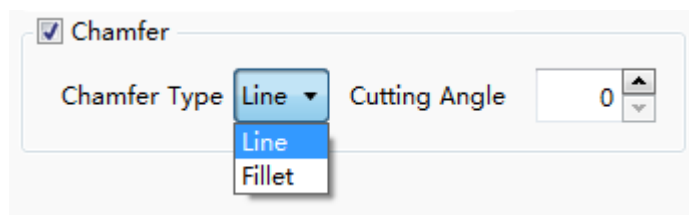

a.



VEDA HCT User Manual

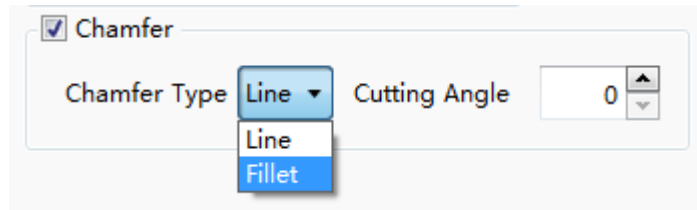

b.



- Position

See [Detailed manual/General functions/Drawing/Position.](#)

- Rotate

See [Detailed manual/General functions/Drawing/Rotation.](#)

- Fill

See [Detailed manual/General functions/Drawing/Filling settings.](#)

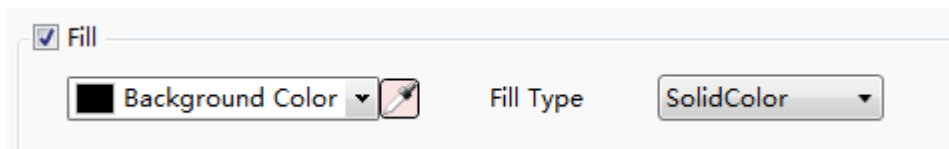

- Shadow Effect

See [Detailed manual/General functions/Drawing/Shadow Effect.](#)

② Dynamic Graphics

See [Detailed manual/General functions/Drawing/Dynamic Graphics](#) for the details.

③ Indicator Light

See [Detailed manual/Component/Indicator Light](#) for the details.

④ Display

See [Detailed manual/General functions/Drawing/Display](#) for the details.

4.5.4 Polygon

Draw a polygon by click the polygon tool. You can find the polygon tool in the shortcut tool bar, the shortcut menu and the pull-down menu.

VEDA HCT User Manual

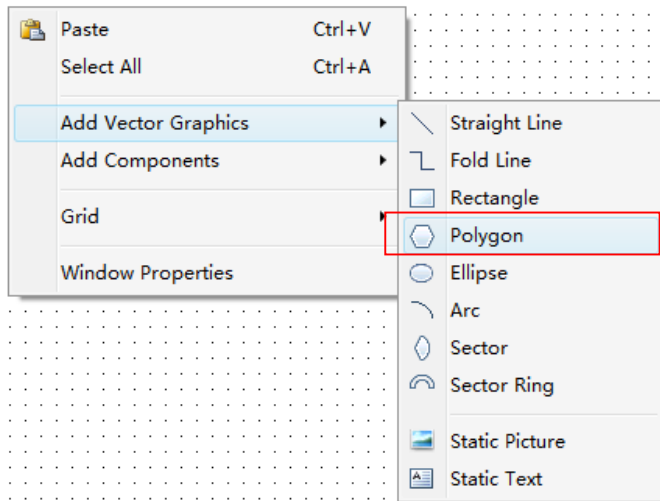
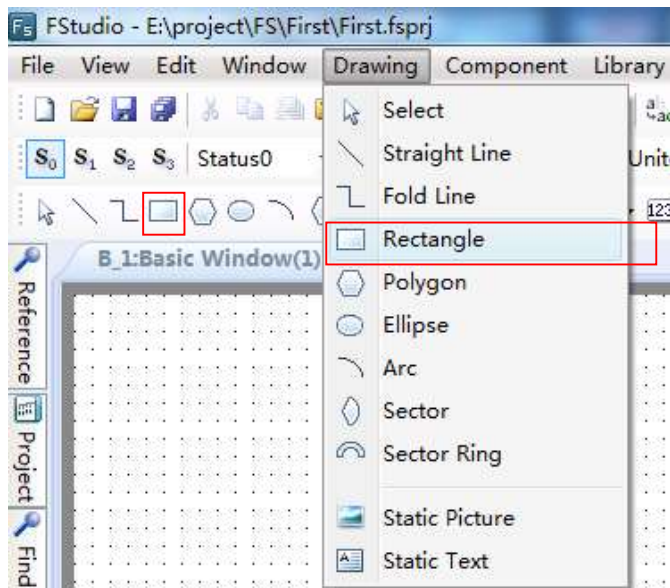

A side will be added every time when the left key is clicked. After all sides are obtained, a polygon can be obtained by clicking the left key and then clicking the right key.

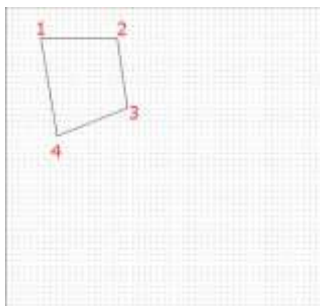

① General

VEDA HCT User Manual

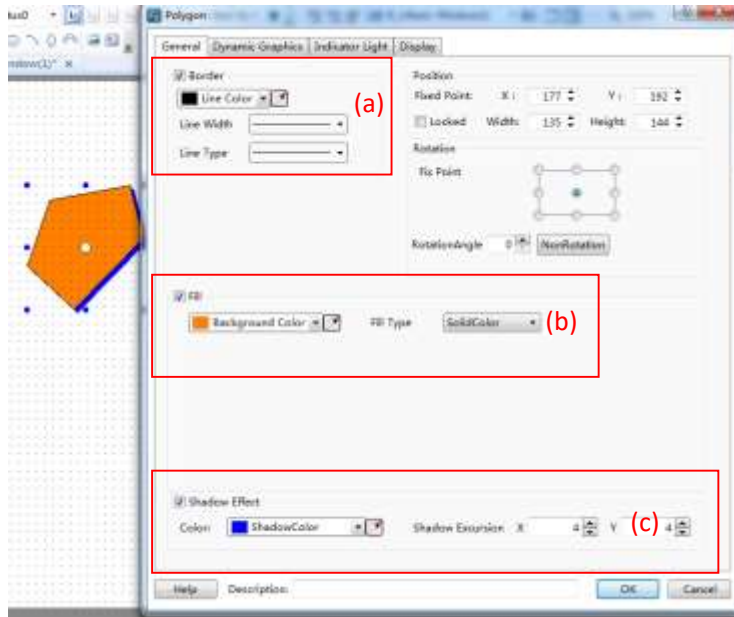

(a)Frame line pattern and frame line width (b)Polygon filling color (c)Polygon shadow effect

Please see details for the using method of polygon drawing.

② Dynamic Graphics

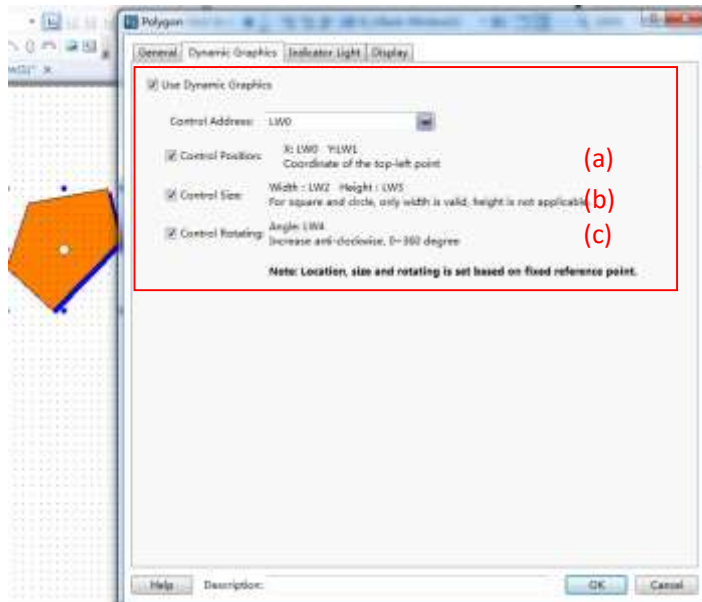

(a) Position control (b) Size control (c) Rotation control

Please see [Detailed manual/General functions/Drawing/Dynamic Graphics](#) for the details.

VEDA HCT User Manual

③ Indicator Light

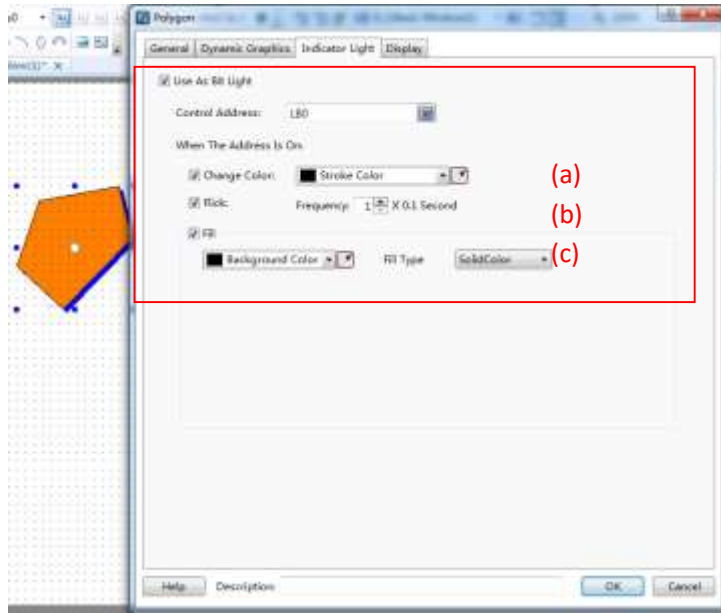

(a) Modify the frame color (b) Control the frequency of flickering (c) Modify the filling color

See [Detailed manual/Component/Indicator Light](#) for the details.

④ Display

See [Detailed manual/General functions/Drawing/Display](#) for the details.

4.5.5 Ellipse

Click the ellipse icon on the tool bar by the left key, or select “Ellipse” command from the menu of Drawing.

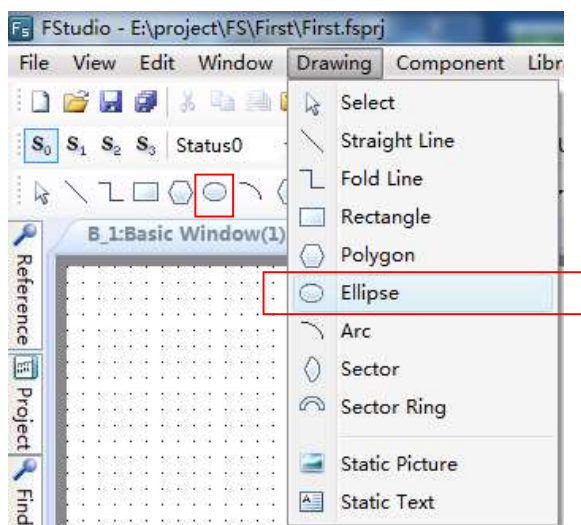

VEDA HCT User Manual

Click and hold the editing area in the window, and drag the mouse to modify the ellipse size and shape.

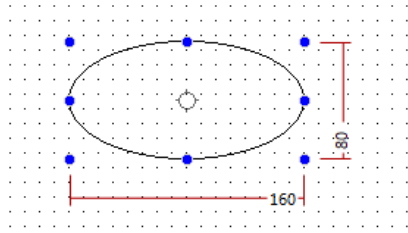

① General

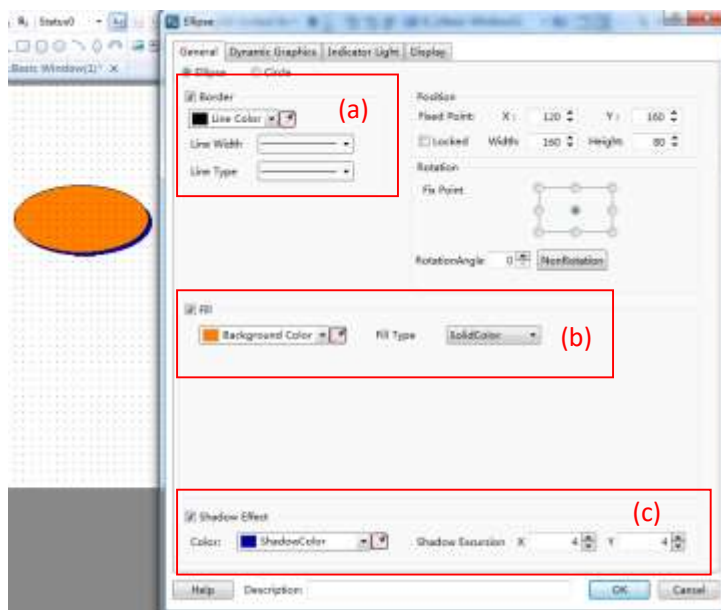

(a) Ellipse border color, width and pattern (b) Ellipse filling color (c) Ellipse shadow effect.

② Dynamic Graphics

VEDA HCT User Manual

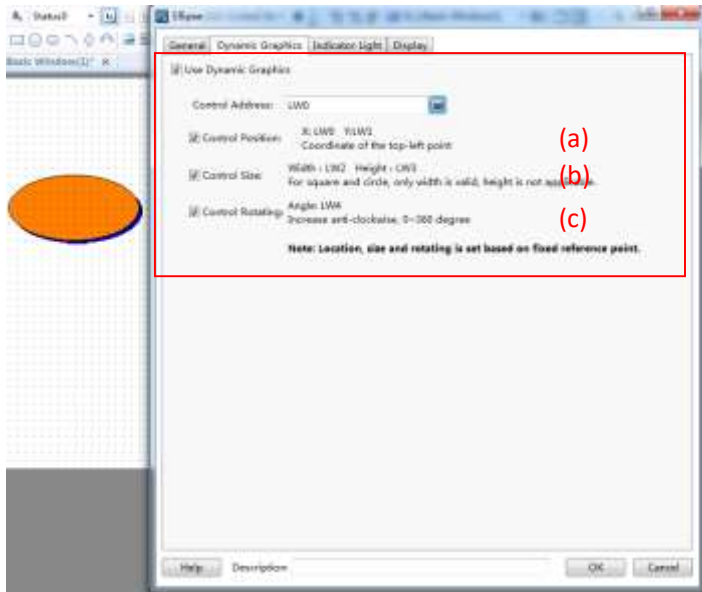

(a) Position control (b) Size control (c) Rotation control

See [Detailed manual/General functions/Drawing/Dynamic Graphics](#) for the details.

③ Indicator Light

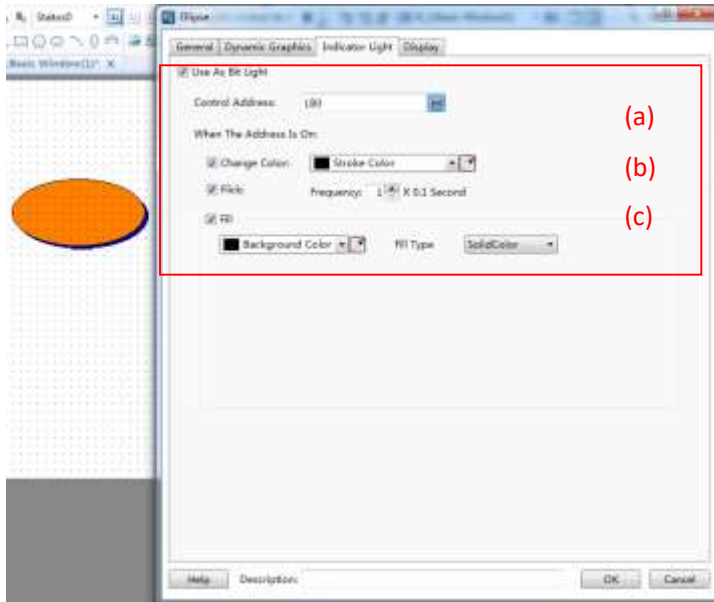

(a) Modify the frame color (b) Control flickering frequency (c) Modify the filling color

See [Detailed manual/Component/Indicator Light](#) for the details.

④ Display

VEDA HCT User Manual

See [Detailed manual/General functions/Drawing/ Display](#) for the details.

4.5.6 Arc

An arc can be drawn in a designated area. The arc component command can be found on the tool bar or from the menu of Drawing.

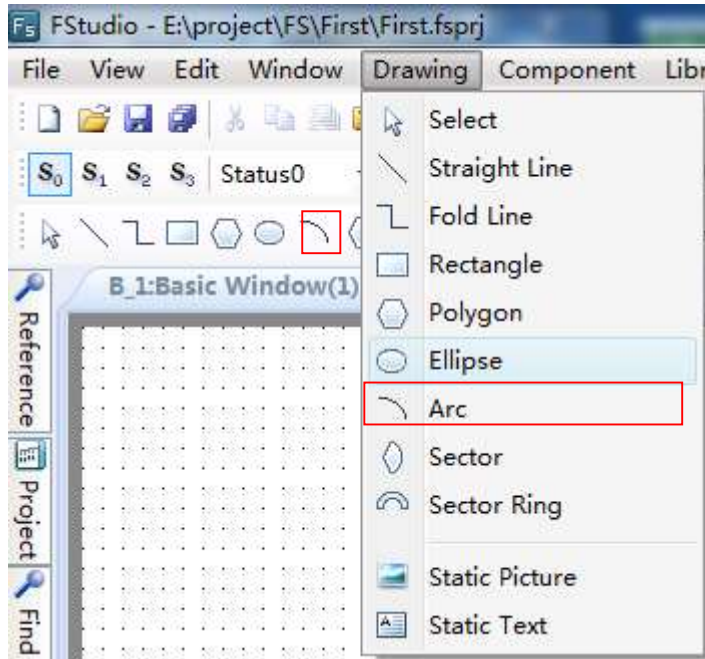

Select the arc component, designate any area to draw, and double click to set the arc properties.

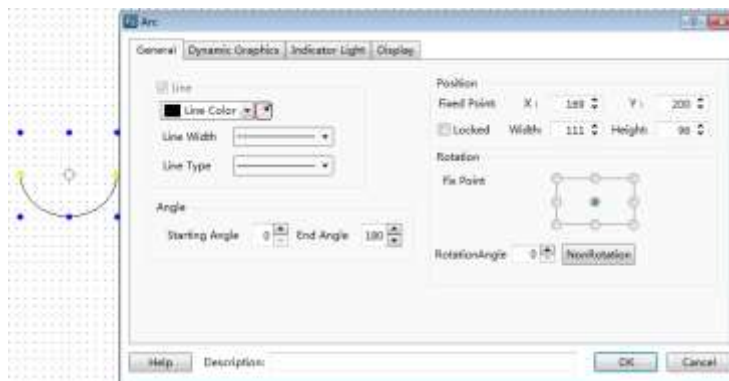

An arc can be got by setting the properties such as line color, width, type, starting angle, end angle, position and rotation. It can be freely drawn by dragging the yellow and blue areas.

VEDA HCT User Manual

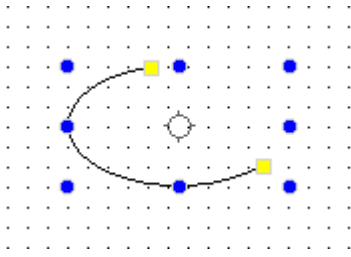

4.5.7 Sector

A sector can be drawn in a designated area. The sector component command can be found on the tool bar or from the menu of Drawing.

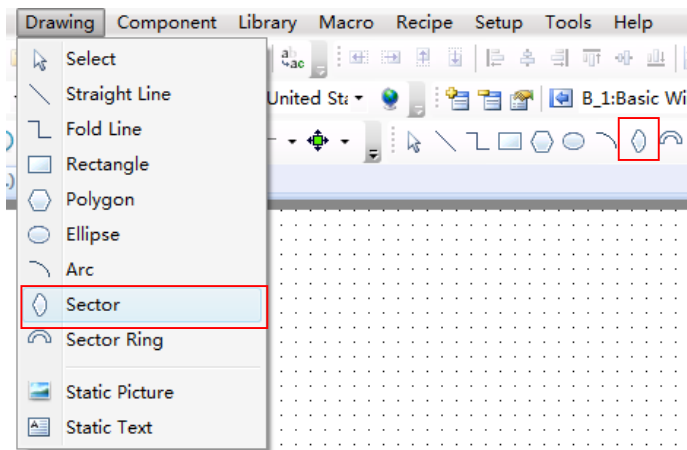

Select the sector component, designate any area to draw, and double click to set the sector properties.

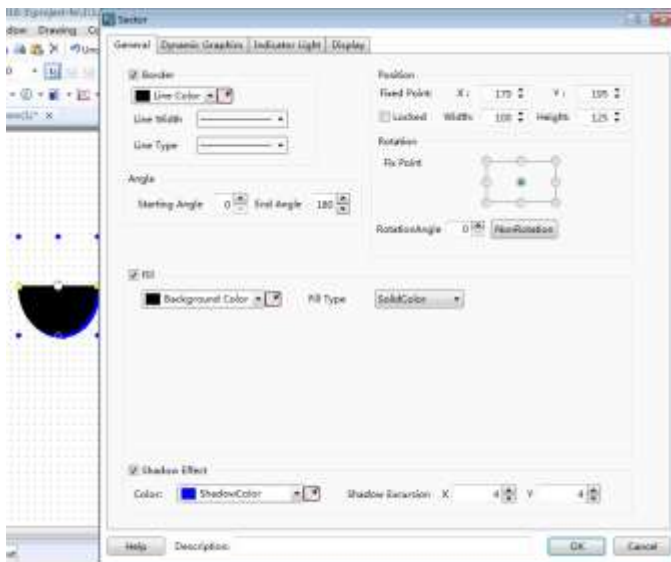

VEDA HCT User Manual

A sector can be got by setting the properties such as line color, width, type, starting angle, end angle, position, rotation, fill color, fill type and shadow effect. It can be freely drawn by dragging the yellow and blue areas.

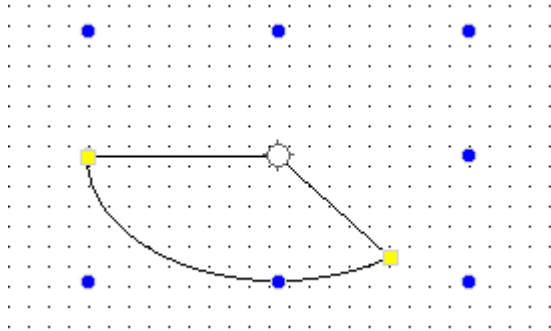

4.5.8 Sector Ring

A sector ring can be drawn in a designated area. The sector ring component command can be found on the tool bar or from the menu of Drawing.

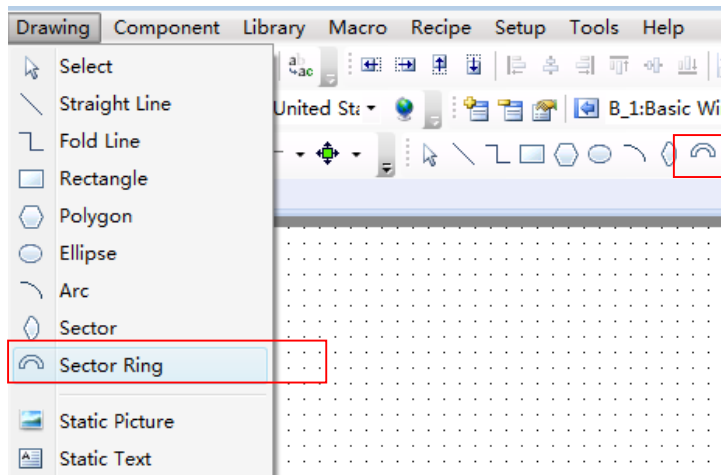

Select the sector ring component, designate any area to draw, and double click to set the sector ring properties.

VEDA HCT User Manual

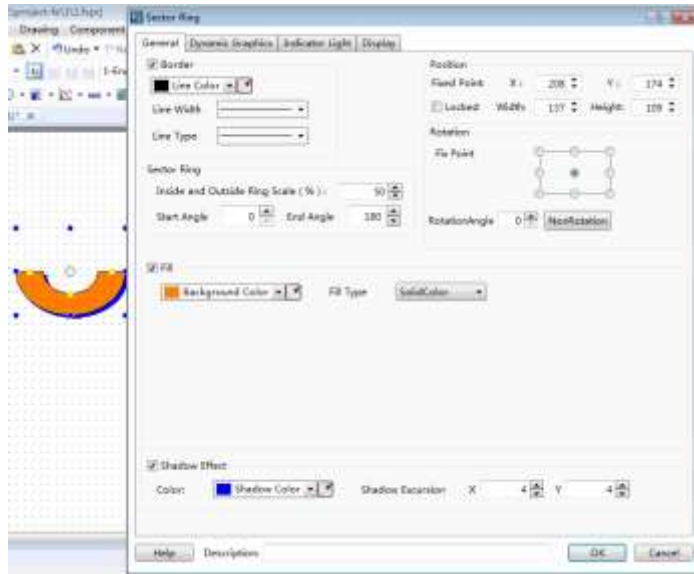

A sector ring can be got by setting the properties such as line color, line width, line type, starting angle, end angle, position, rotation, fill color, fill type and shadow effect. It can be freely drawn by dragging the yellow and blue areas.

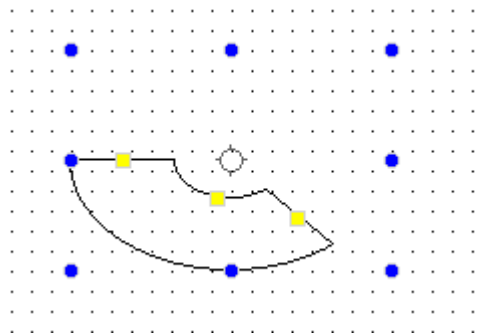

4.5.9 Static Picture

In this software, the “Static Picture” function will be used frequently. This function can make the whole project more clear and beautiful. The static picture command can be found from the shortcut tool bar or the pull-down menu of Drawing.

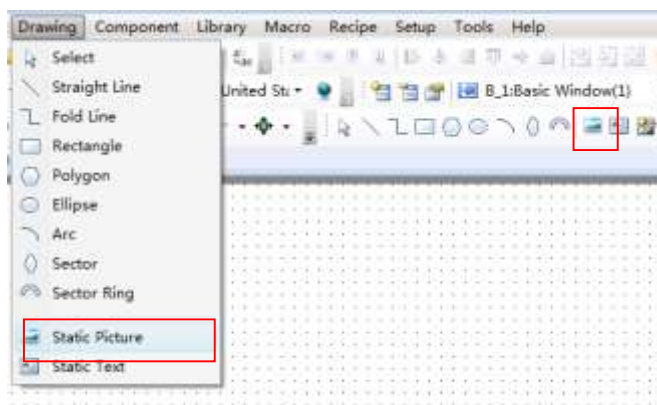

VEDA HCT User Manual

After the static picture component is selected, drag by the left key of the mouse, and then the corresponding properties window will pop up.

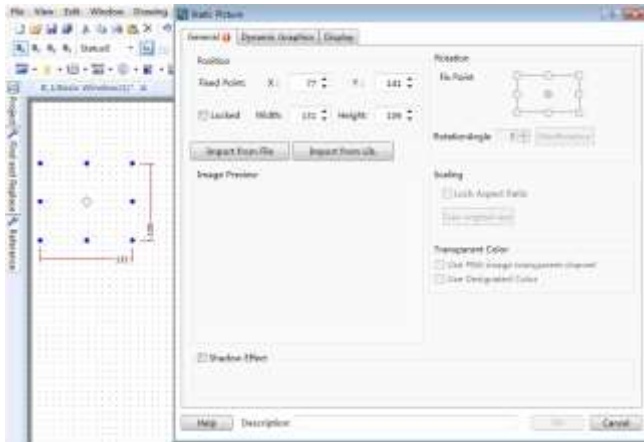

Local picture in the computer or in the software picture library can be imported by clicking the “Import from File” button or the “Import from Lib” button. And the picture will be put into the window by clicking the “OK” button.



The static picture position can be modified. You can change the position by manually dragging or by setting the coordinates in the static picture properties window. The static picture size can be modified, too.

VEDA HCT User Manual

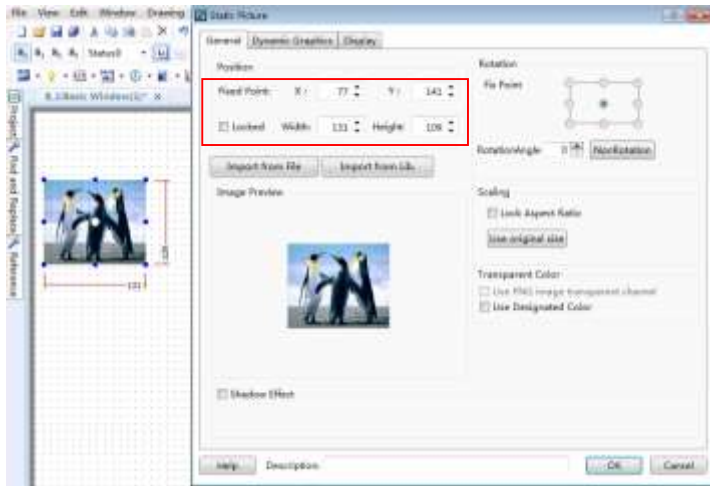

The static picture size and position can be fixed if the “Locked” is checked. And the static picture can be rotated around a fixed point. The fixed point and rotation angle can be set. The picture can be manually rotated (in any angle) after the fixing angle is set.

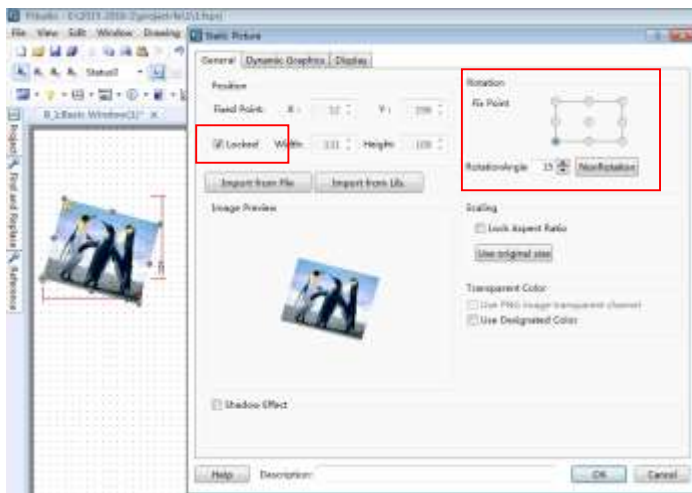

The static picture size can be set in the properties window by the Scaling function. It can be set either by checking “Lock Aspect Ratio” (the fixed horizontal/vertical ratio) or by checking “Use original size” (keeping the original size).

VEDA HCT User Manual

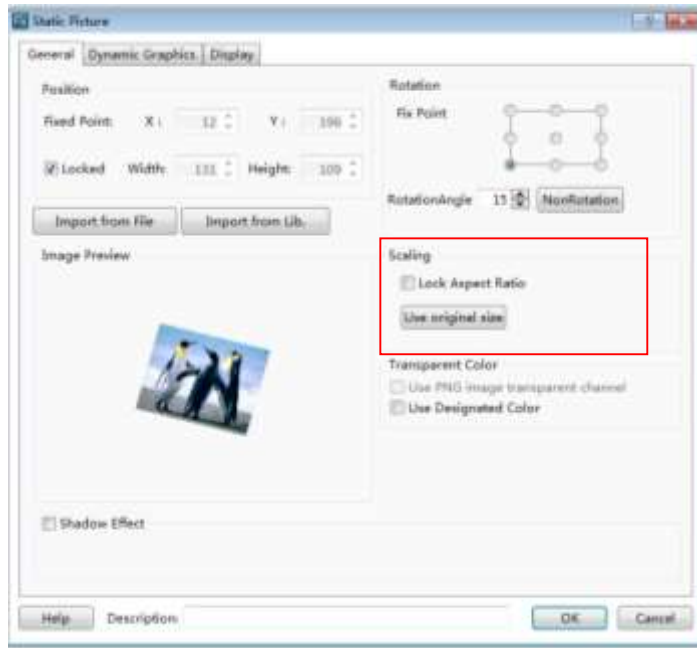

The picture effect can be beautified by the Shadow Effect function so that it can be differentiated from the background.

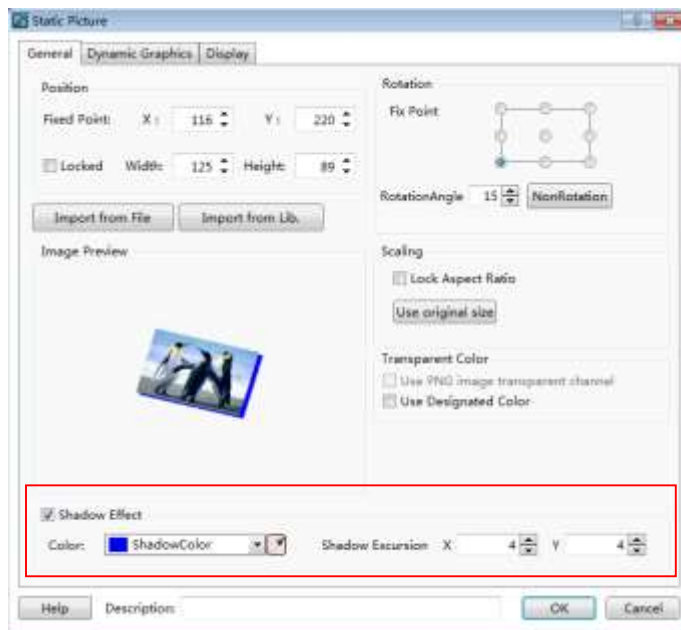

The static picture can be set to display only when the corresponding conditions are satisfied. The user can choose that the static picture is displayed all the time or displayed in conditions by setting the Display properties. The conditional display type includes Level User, Privilege User and Logic Control.

Level User: The static picture will be displayed only in the corresponding user level. It can be activated by checking it.

VEDA HCT User Manual

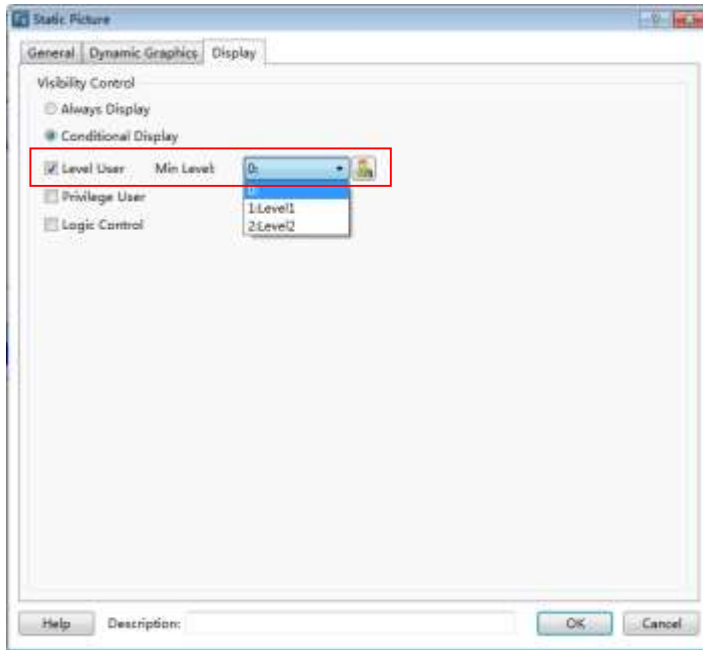

Privilege User: The static picture visibility control needs an authority. The authority system settings dialog can be opened by clicking the button “”.

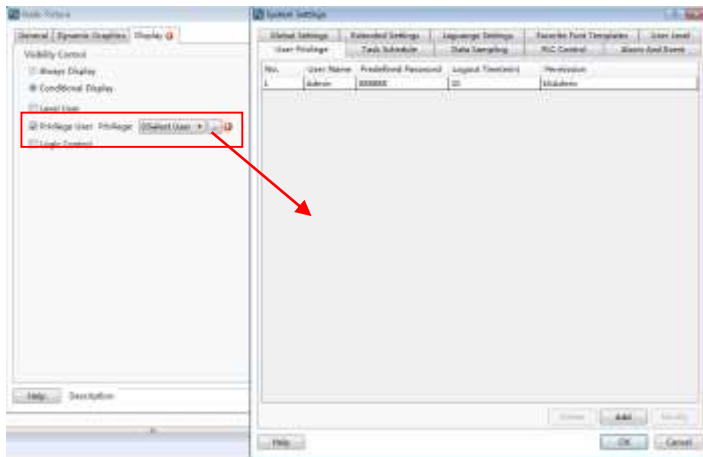

Logic Control: The static picture visibility can be controlled by the address conditions. The conditions include bit control (address ON and OFF) and word control (word address value conditions).

VEDA HCT User Manual

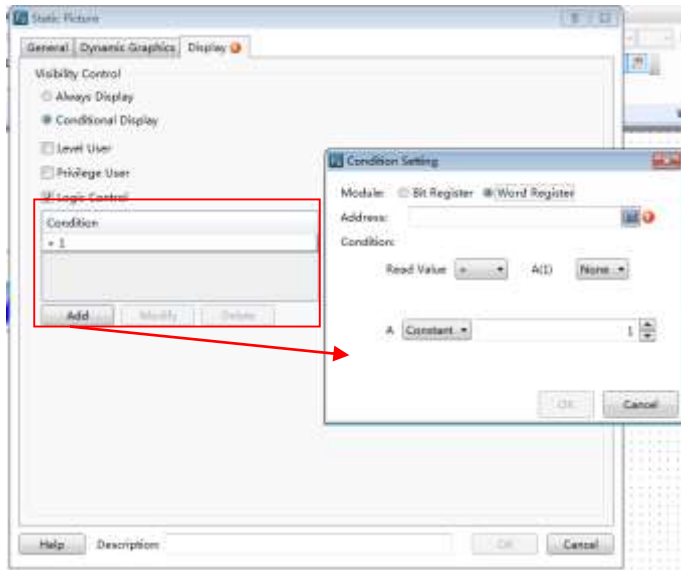

The static picture can be converted into a dynamic one by logic control. Static pictures can be quickly switched by picture stacking and the control address.

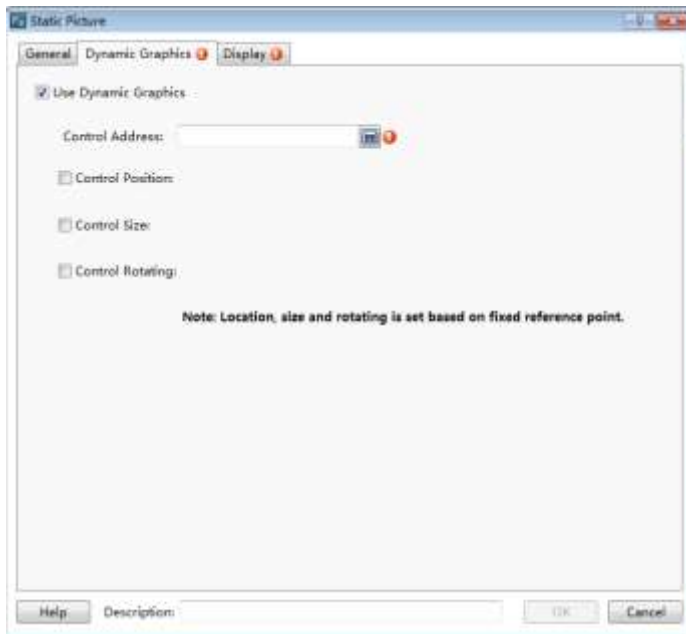

When the control address is fixed, the position, size and rotation can be controlled. E.g.: when there are many sector pictures, they can be set to display rotating effect by setting the Control Rotating.

VEDA HCT User Manual

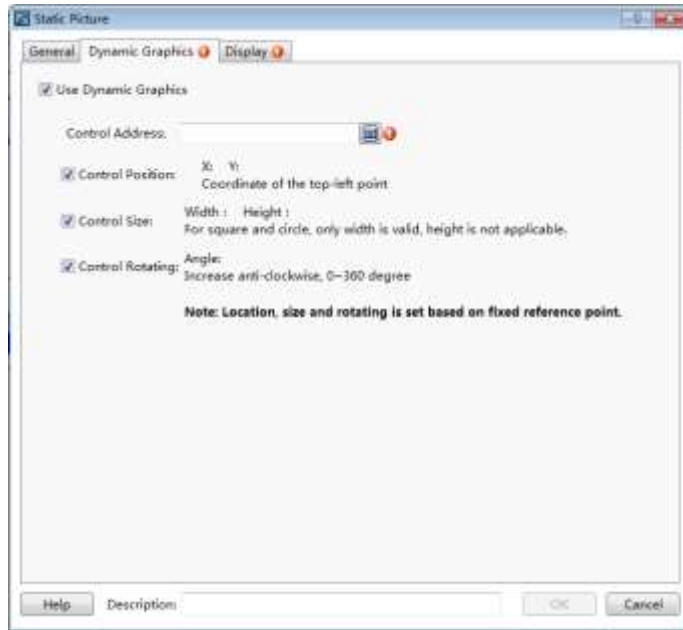

4.5.10 Static Text

When editing in the software, a lot of texts will be used for marking, displaying and describing, and thus the project edited can be easy to understand. The Static Text command can be found from the shortcut tool bar or the menu of Drawing.

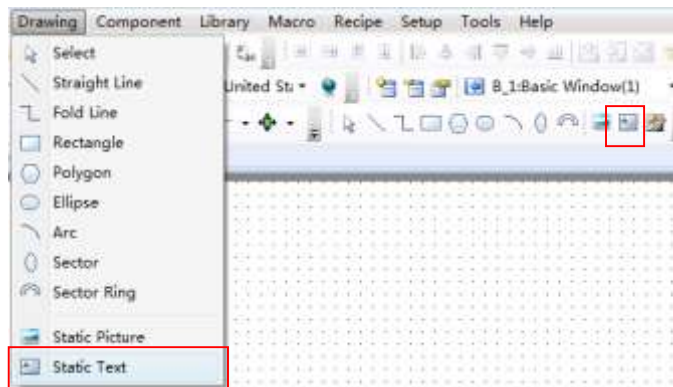

When click the Static Text command, the properties dialog will pop up. The content of the static text to be displayed can be written into the Tag Contents. The font, size, color and alignment mode can be set here.

VEDA HCT User Manual

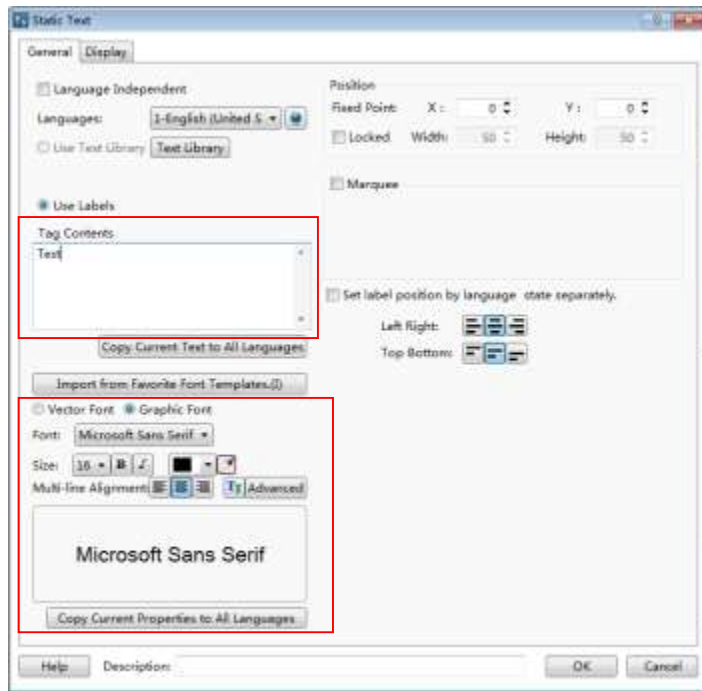

These properties such as the current text font, size, color and the alignment mode can be copied to make future texts uniform.

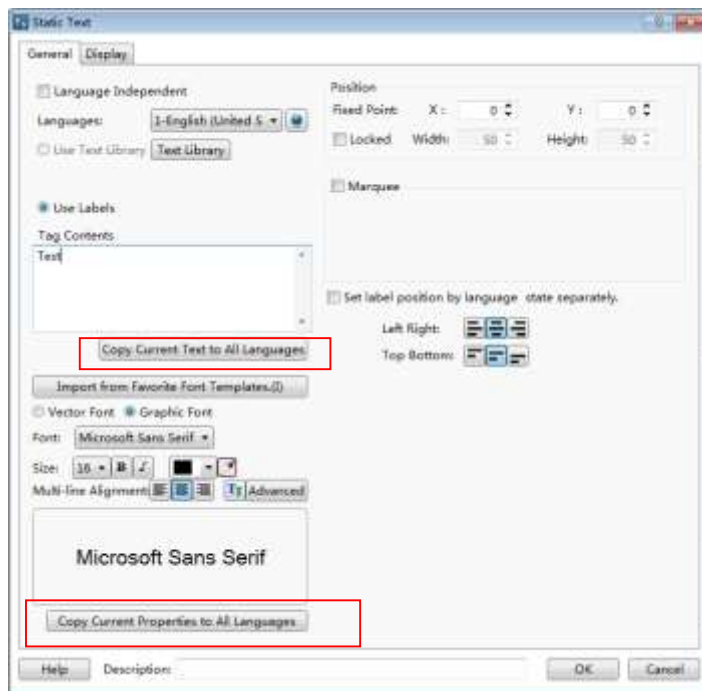

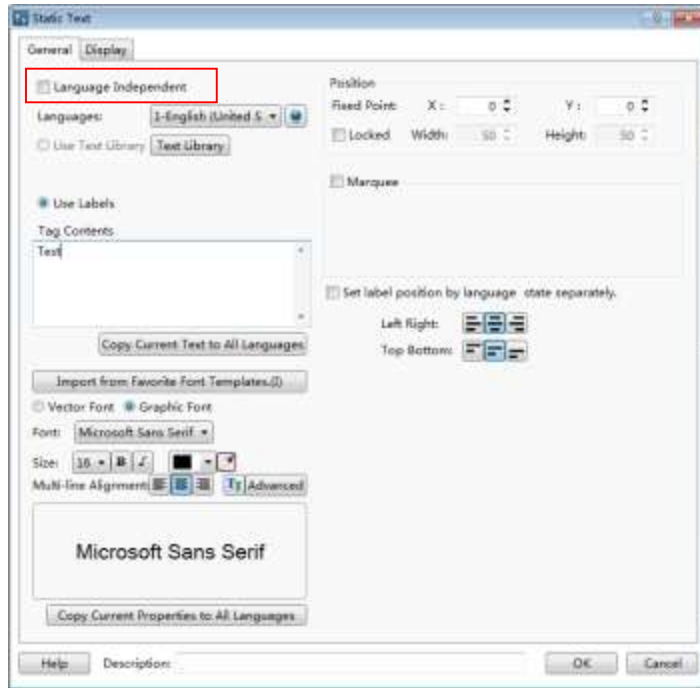

The function “Language Independent” can be checked to make sure the text is not influenced by other languages.

VEDA HCT User Manual

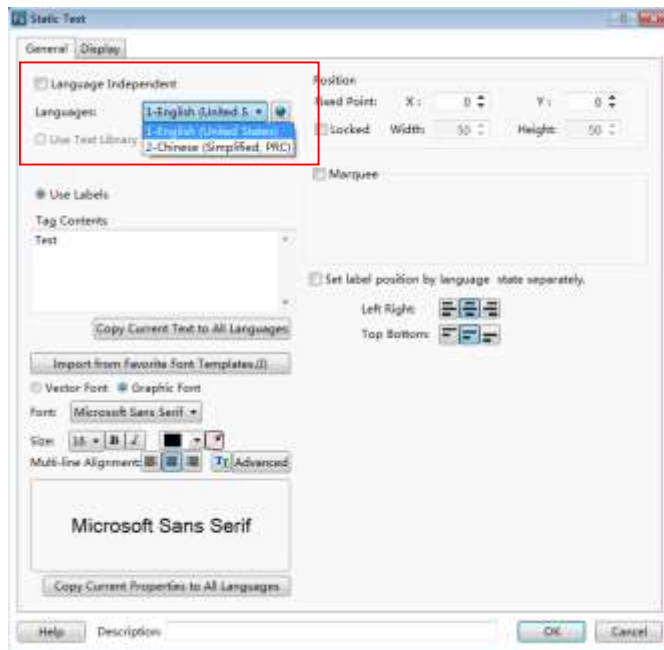

Sometimes, the project is provided to the users in different countries. You can set the different contents by switching Languages. Thus different texts can be displayed in different languages.



Multi languages can be set in System Settings dialog which is opened by clicking the button  to satisfy the different languages requirement.

VEDA HCT User Manual

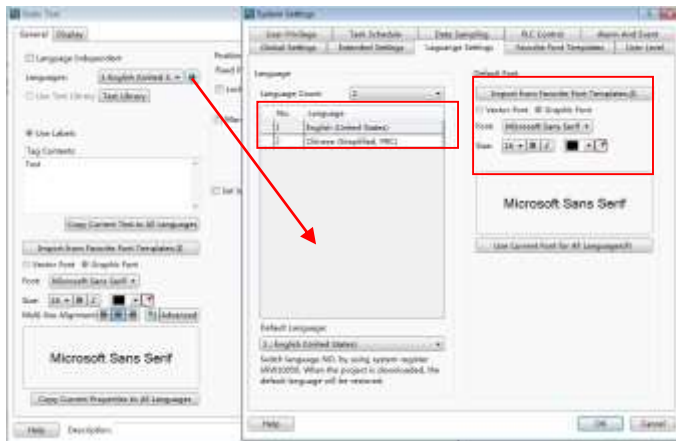

When you check the “Set label position by language state separately” function, different texts can be aligned in different effects.

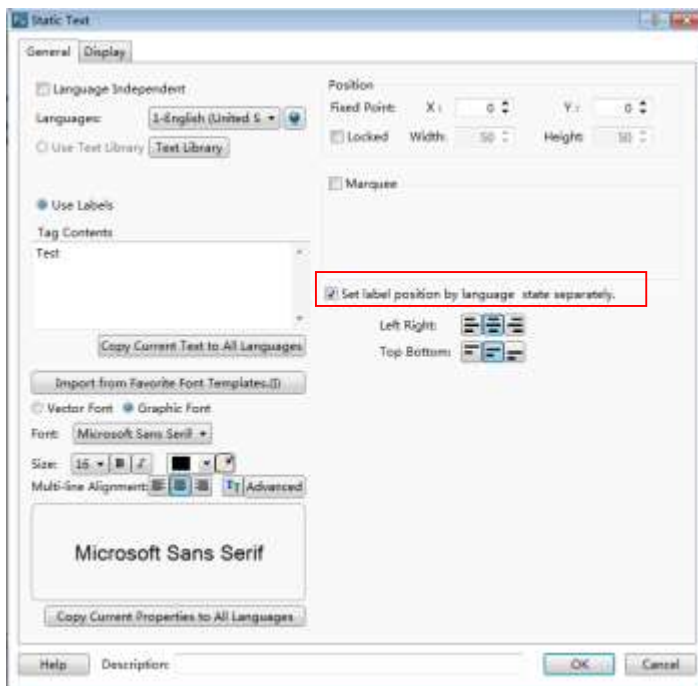

The static text can be used which is saved in the text library. The text library dialog can pop up by clicking the “Text Library” button. You can enter the text in the text library dialog in advanced and select it to use.

VEDA HCT User Manual



The static text can be set to a designated position, and the text can be locked to prevent any displaying defect caused by moving.

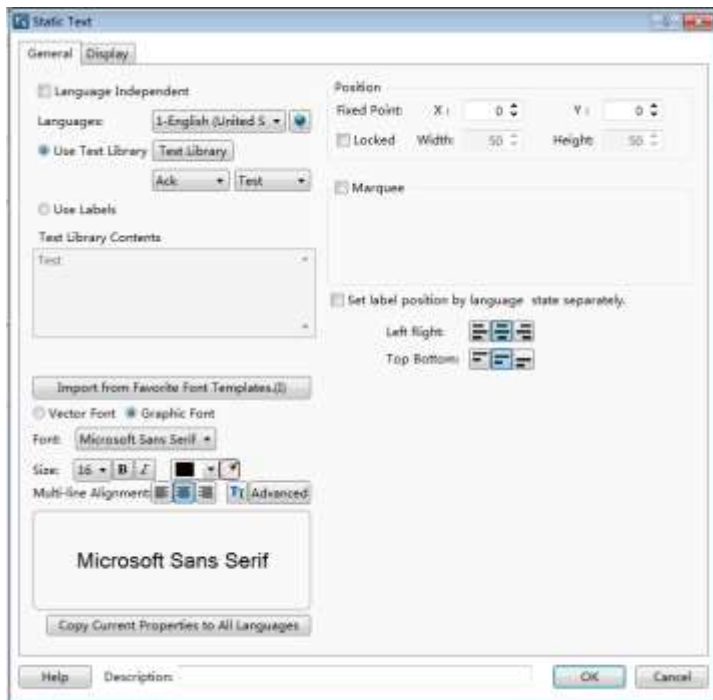

When the text includes a lot of words and characters, the revolving displaying function can be used to save the space. The revolving displaying function can be used by checking the “Marquee” function. The moving direction and the revolving displaying speed can be set in the properties dialog of the static text.

VEDA HCT User Manual

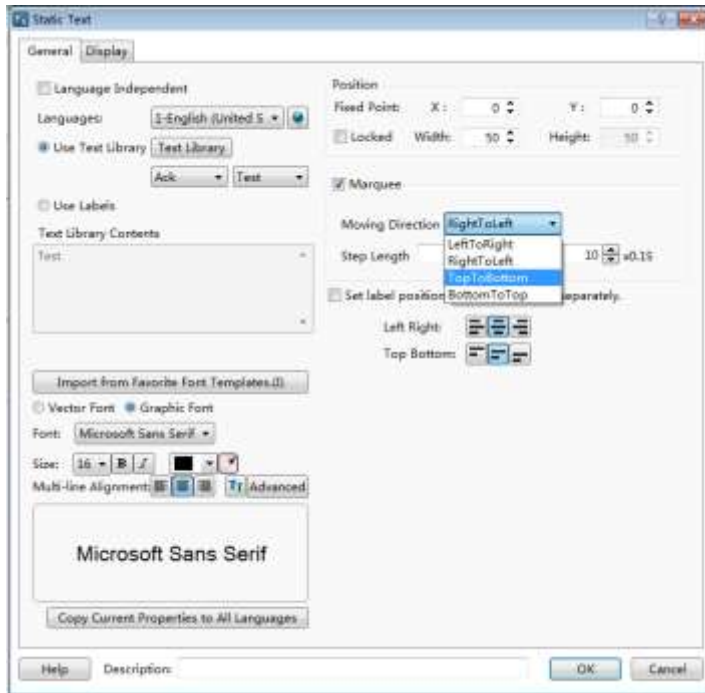

Similar to static picture functions, the static text can be also set to display only if necessary. The user can choose that the static text is displayed all the time or displayed in conditions by setting the Display properties. The conditional display type includes Level User, Privilege User and Logic Control.

Level User: The static text will be displayed only in the corresponding user level. It can be activated by checking it. The user level system settings dialog can be opened by clicking the button

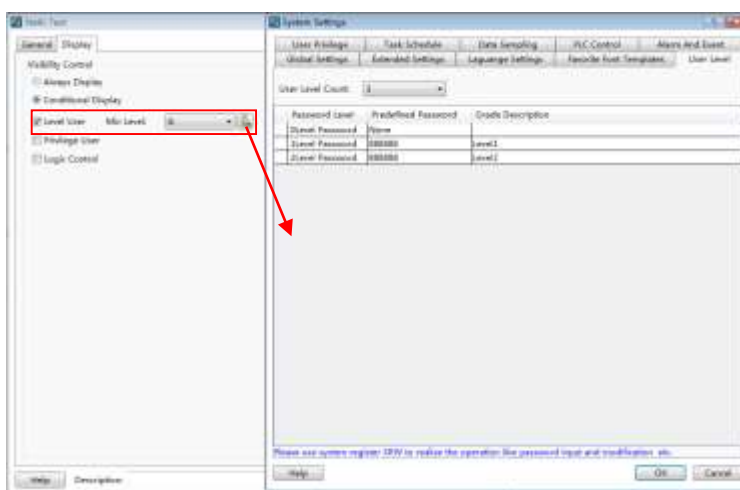

Privilege User: The static text visibility control needs an authority. The authority system settings dialog can be opened by clicking the button “...”.

VEDA HCT User Manual

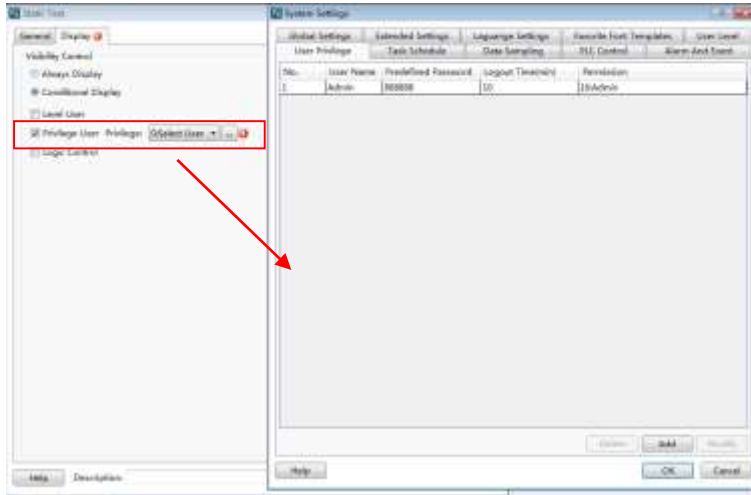

Logic Control: The static text visibility can be controlled by the address conditions. The conditions include bit control (address ON and OFF) and word control (word address value conditions).

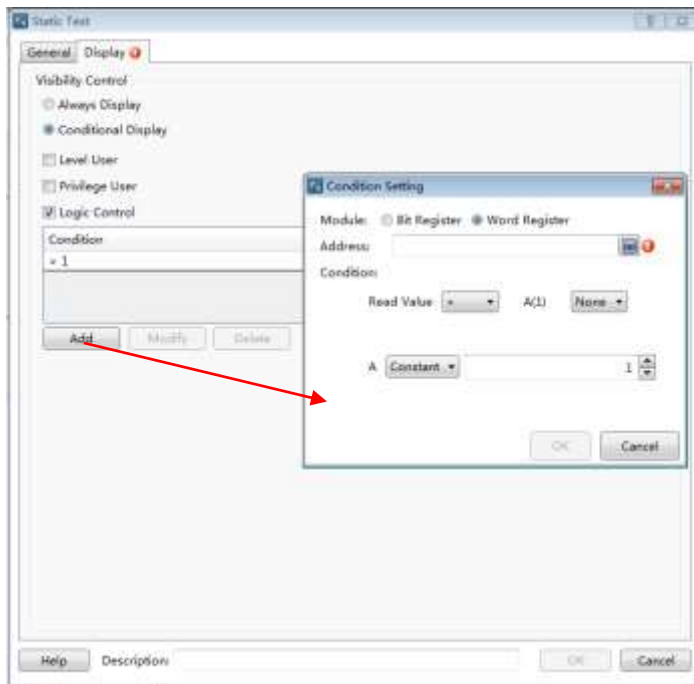

4.6 Component

4.6.1 Switch

The Switch component includes Bit Set, Word Set, Window Operation, Function Key, Data Transferring and Recipe Transmission.

VEDA HCT User Manual

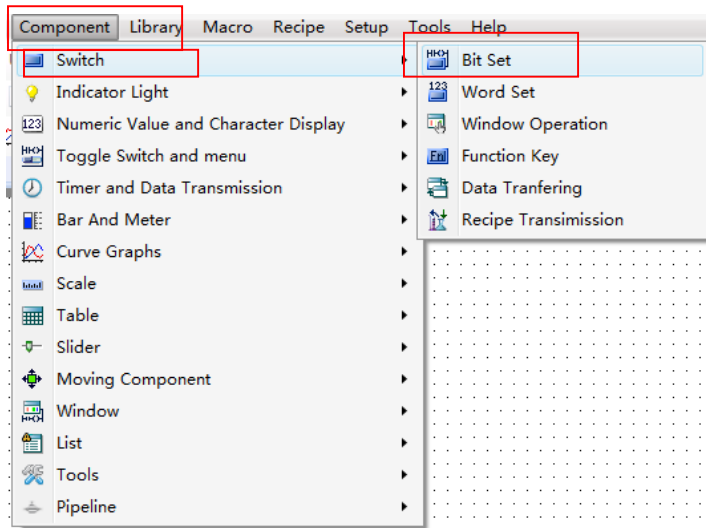

4.6.1.1 Bit Set

“Bit Set” is a component by which the internal bit address of HMI or the bit address of each controller connected to HMI is operated. The type of “Execute Setting” includes “On”, “Off”, “Inverse”, “Reset”, “On Pulse” and “Off Pulse”.

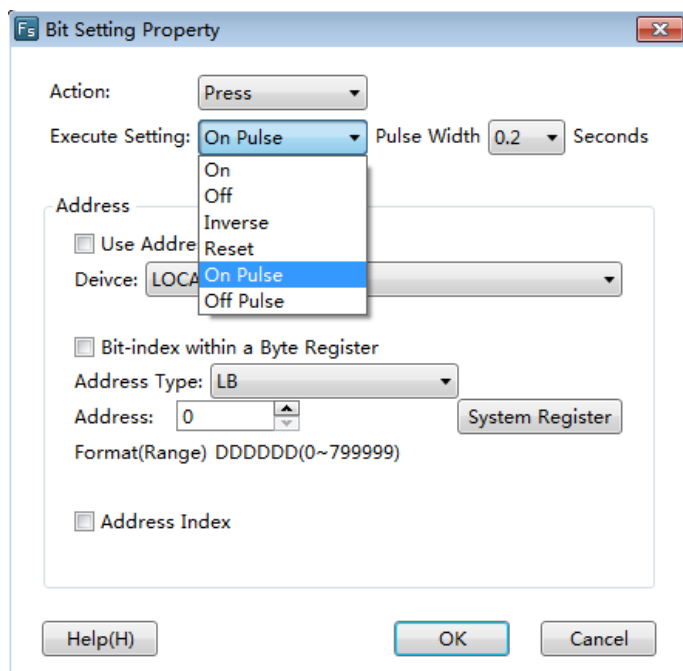

- On
Set the bit address to ON.
- Off
Set the bit address to OFF.
- Inverse
It is set a “Switch” by which the current state can be conversed. If the current bit address is

VEDA HCT User Manual

ON, after it is operated, the bit address will be converted to OFF. If the current bit address is OFF, after it is operated, the bit address will be converted to ON.

- Reset

When it is operated and kept being held, the bit address is set at the ON state all the time. When it is released, the state of the bit address will be immediately switched to OFF.

- On Pulse

A rising edge pulse is produced which the bit address keeps the pulse “on” in a designated time width. The pulse width range is 0.1~1.5 seconds.

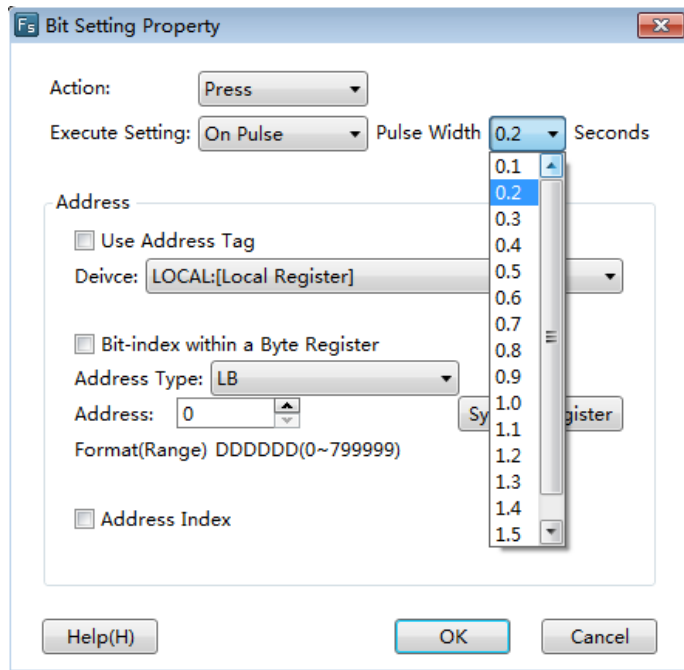

- Off Pulse

A falling edge pulse is produced which the bit address keeps the pulse “off” in a designated time width. The pulse width range is 0.1~1.5 second.

For the “On Pulse”, if the pulse width is set to 1 second and the current bit state is OFF, a 1 second ON pulse signal will be produced and then it goes back to the OFF state. If the current bit state is ON, a 1 second ON time will be still set because the bit state is already ON, and then the bit state will turn OFF.

Similar to the “Off Pulse”, if the pulse width is set to 1 second and the current bit state is ON, a 1 second OFF pulse signal will be produced and then it goes back to the ON state. if the current state is OFF, a 1 second OFF time will be still set because the bit state is already OFF, and then the bit state will turn ON.

There is an “Action” attribute for the Bit Set component. It includes two options, “Press” and “Release”. When the “Bit Set” component is pressed down, the bit set function will be executed immediately. When the “Release” attribute is selected and the “Bit set” component is pressed,

VEDA HCT User Manual

the bit set function will not be executed. And when it is released, the “Bit set” function will be executed immediately. But the action is not valid when the “Execute Setting” is “Reset”.

The “Bit Set” component has other property pages. For example, in the “Indicator Light” property page, it is recommended to check the “Use Indicator” option and set an address to monitor the “Bit set” component state if the “Use Graphics” option is checked in the “Graphics” property page. The details can be seen in the “System Manual/ Component/ Indicator Light”.

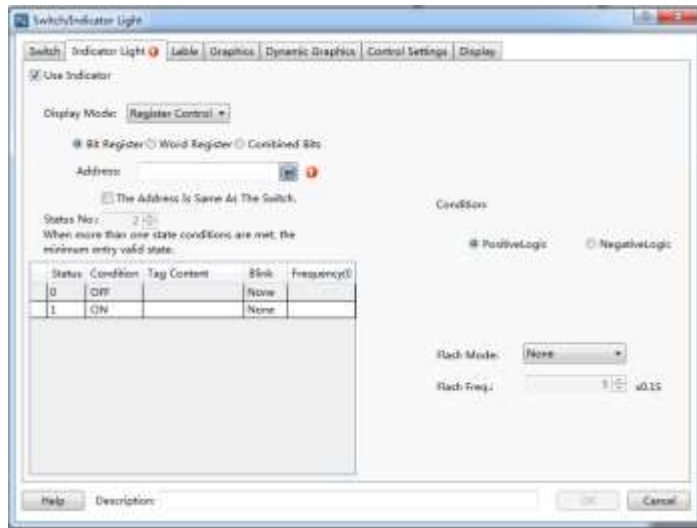

The following brief example introduces the process for setting the HMI internal address LB100 into the “Inverse” attribute.

- In the software menu, click “Component/ Switch/ Bit Set” to open the following dialog.

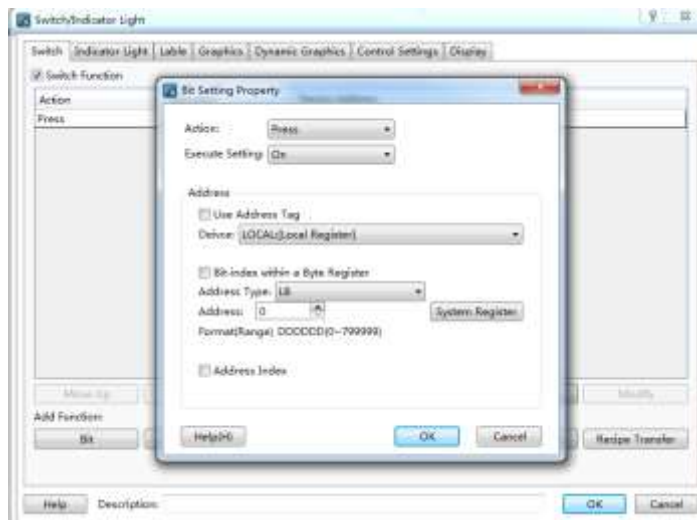

The default action is “Press”. The default Execute Setting is “On”. The default address is “LB0”. They are modified into the required as follows.

VEDA HCT User Manual

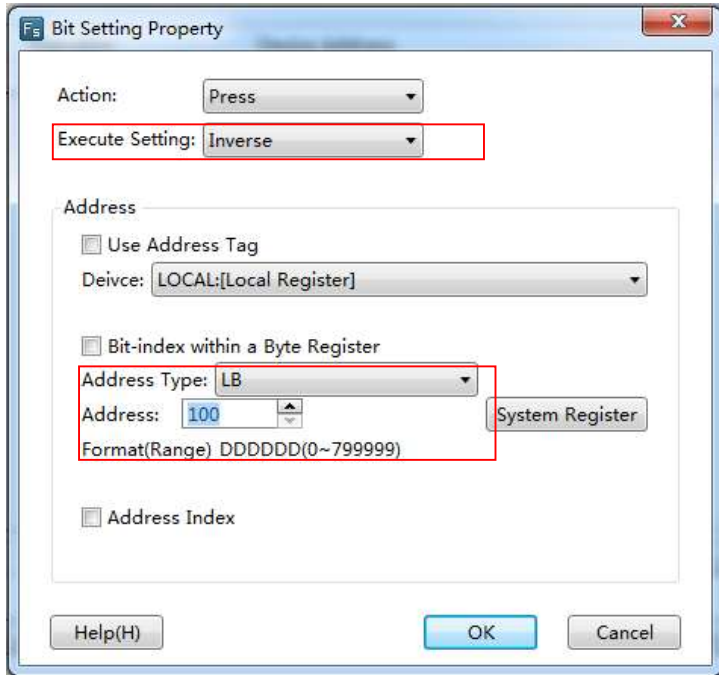

- Click "OK" to add an operation action in the "Switch" list.

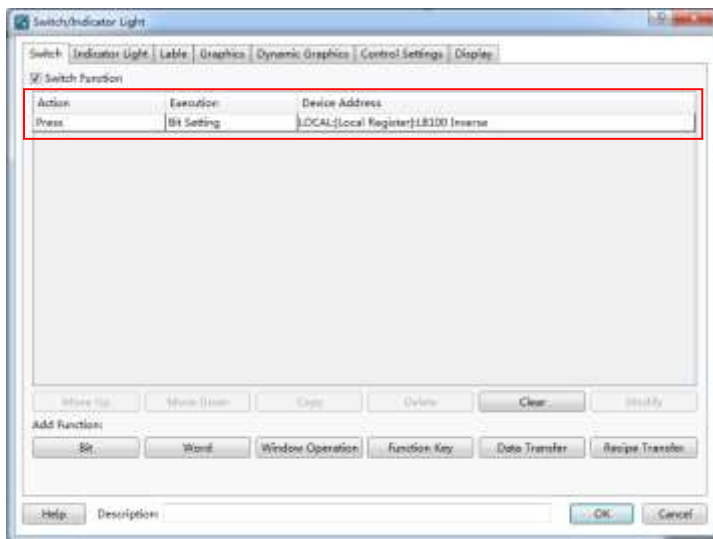

In the list, we can clearly see the execution attribute and the bit address to be operated.

Click "OK" in the Switch dialog to put the component into the window edited. In this way, a simple "Bit Set" component is finished.

4.6.1.2 Word Set

"Word Set" is a component by which various attributes of the internal word register of HMI or the word register of any controller connected to HMI are controlled. The Word Set property dialog can be opened by clicking the "Component/ Switch/ Word Set" in the menu. The default settings are shown as follows.

VEDA HCT User Manual

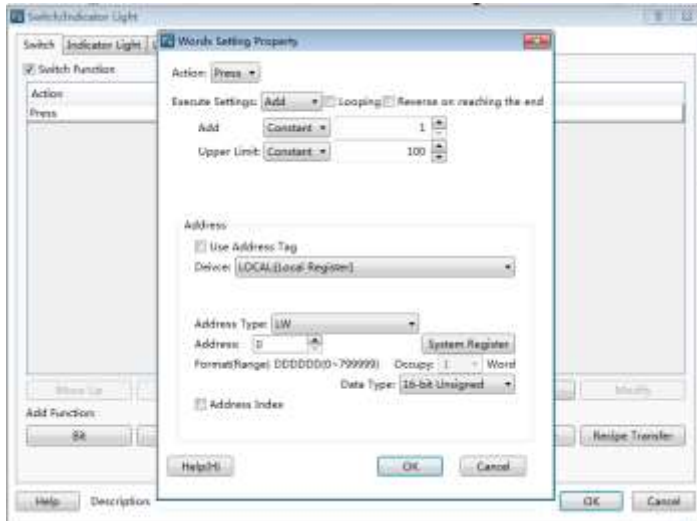

The type of “Execute Settings” includes “Add”, “Subtract”, “Increase”, “Decrease”, “Set Up Constants”, “Set Up Character Strings”, “Set Up Figures By Bit” and “Logic Operation”.

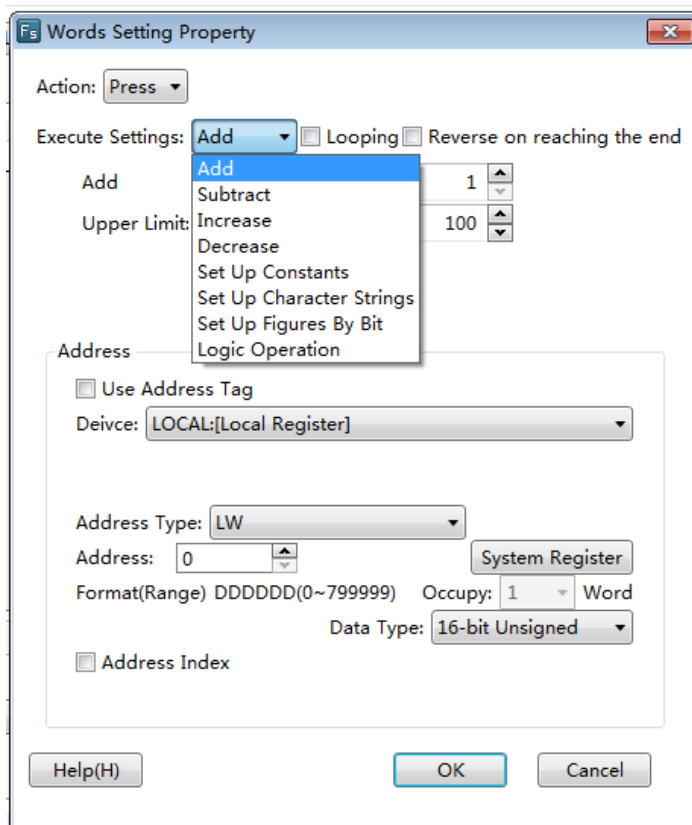

- Add

A designated data will be added to the value of the designated word register. The “Add” attributes contain the following settings.

VEDA HCT User Manual

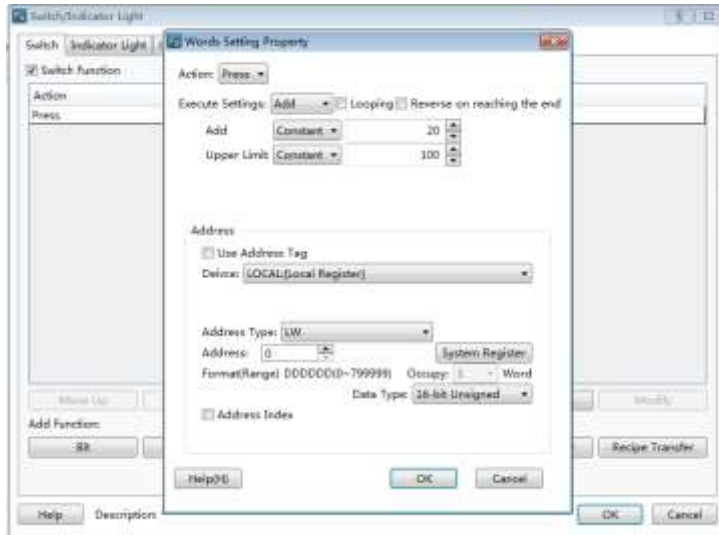

➤ Add

At each time of operation, the set data will be added and written into the word register.

➤ Upper Limit

It is the upper limit of the word register operated. When the result reached the upper limit of operation, no further “Add” operation can be done.

➤ Looping

If “Looping” is checked, an option of “Lower limit” will appear. The operation will be continued at the upper limit and the adding operation will be done from the lower limit. For example, if the “Lower limit” is set to “0”, the “Add” is set to “1”, and the upper limit is set to “100”, the Word Set component will be valid when it is added to “100”. It will turn to 0, 1, 2, 3, and so on, at the next operations.

➤ Reverse on reaching the end

If “Reverse on reaching the end” is checked, the operation will be continued at the upper limit and the result will change to reduce from the upper limit to the lower limit. When the result reached the lower limit, the operation will change to add.

The “Add”, “Upper limit” and “Lower limit” are all “Constant” in default. They can also be set into “Variable”. It is noted that the data type of variable register must comply with the “Word Set” component address type.

● Subtract

A designated data will be subtracted from the value of the designated word register till the “Lower limit”. The “Subtract” attributes contain the following settings.

VEDA HCT User Manual

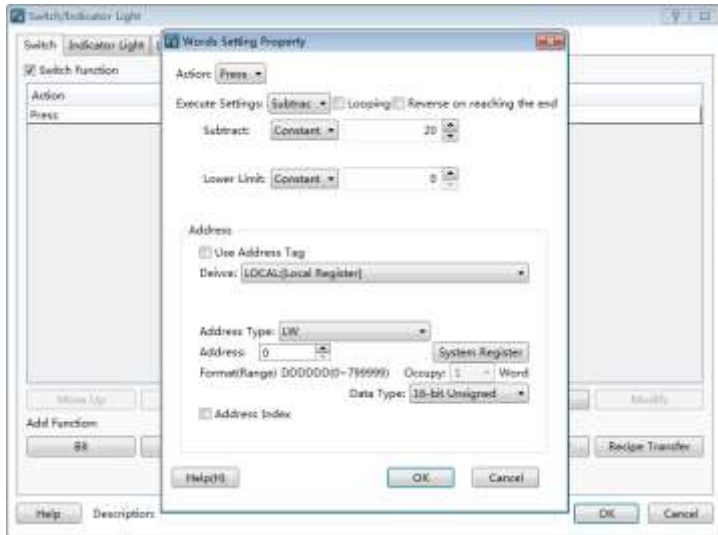

- **Subtract**

At each time of operation, the set data will be subtracted from the word register.

- **Lower Limit**

It is the lower limit of the word register operated. When the result reached the lower limit of operation, no further “Subtract” operation can be done.

- **Looping**

If “Looping” is checked, an option of “Upper limit” will appear. The operation will be continued at the lower limit and the subtraction will be done from the upper limit. For example, if the “Lower limit” is set to “0”, the “Subtract” is set to “1”, and the upper limit is set to “100”, the Word Set component will be valid when it is subtracted to “0”. It will turn to 100, 99, 98, 97, and so on, at the next operations.

- **Reverse on reaching the end**

If “Reverse on reaching the end” is checked, the operation will be continued at the lower limit and the result will change to add from the lower limit to the upper limit. When the result reached the upper limit, the operation will change to subtract.

- **Increase**

The result value will keep increasing if the component of “Increase” is pressed down. The increasing will stop if the component of “Increase” is released or the value reaches the upper limit. The component of “Increase” has attributes of “Immediately Execute Increase/Decrease Action”, “Delaying Time” and “Execution Time”.

VEDA HCT User Manual

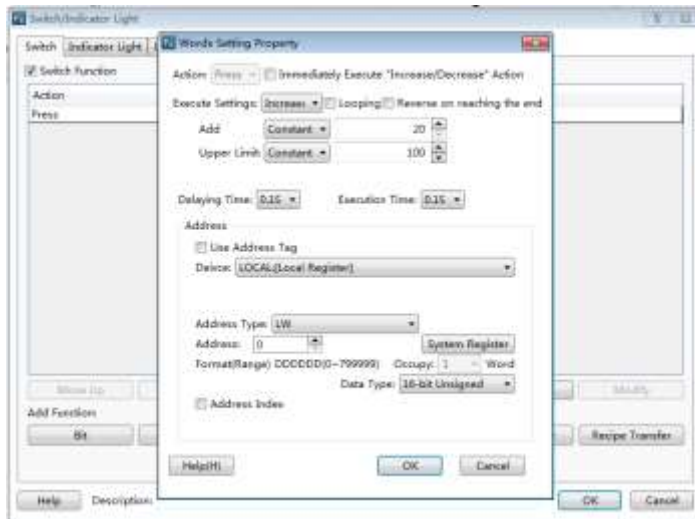

- Immediately Execute Increase/Decrease Action

“Increase” and “Decrease” all have this attribute. If it is checked, the operation of “Increase” or “Decrease” will be executed immediately without waiting when the component is pressed down.

- Delaying Time

When the attribute of “Immediately Execute Increase/Decrease Action” is not checked, the “Delaying time” attribute is valid. The default time is 0.1s and the maximum is 1.5s. If the time is 0.1s, it means the action of “Increase” will be delayed 0.1s to execute after the component is pressed down.

- Execution Time

The “Execution Time” means the time to execute the action “Increase” once. The time range is 0.1s ~ 1.5s.

- Decrease

The function of “Decrease” is similar to the attribute of “Increase”. The result value will keep decreasing if the component of is pressed down. The component of “Decrease” also has attributes of “Immediately Execute Increase/Decrease Action”, “Delaying Time” and “Execution Time”.

VEDA HCT User Manual

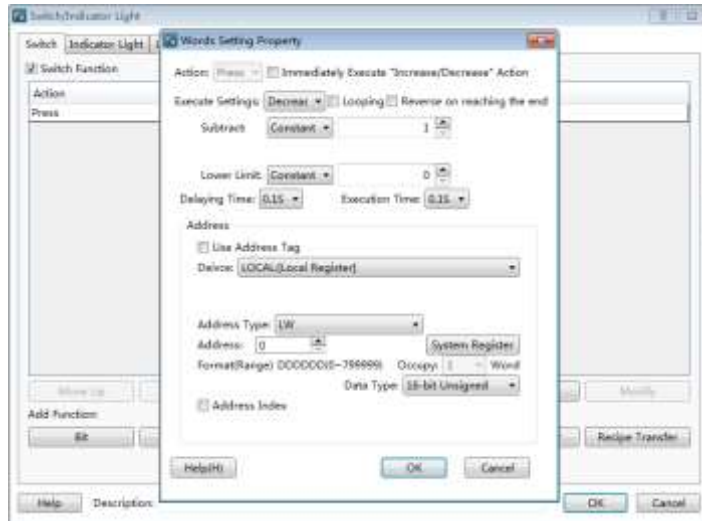

- Set Up Constants

A data is written to the designated register. The data (Setting Value) can be a “Constant” or a “Variable”.

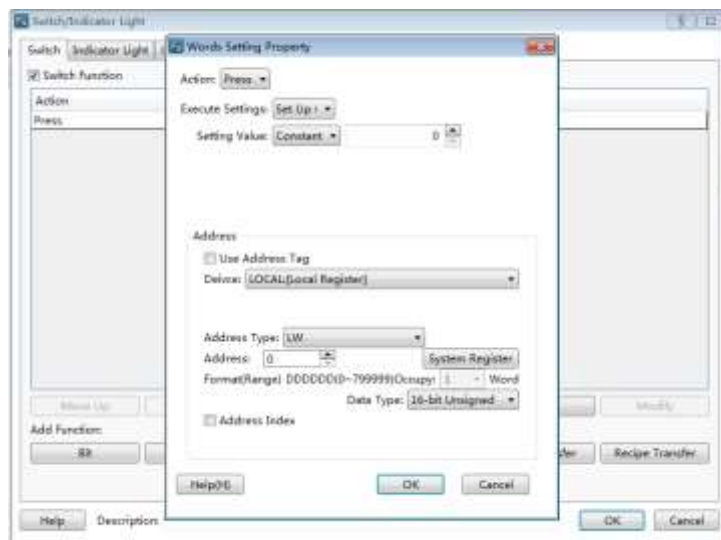

In the figure above, a constant “0” is written to the register LW0 of HMI.

- Set Up Character Strings

This function is similar to “Set Up Constants”. A character string can be written to the word register. For example, character string “A123” is written to the register LW0 and LW1 of HMI.

VEDA HCT User Manual

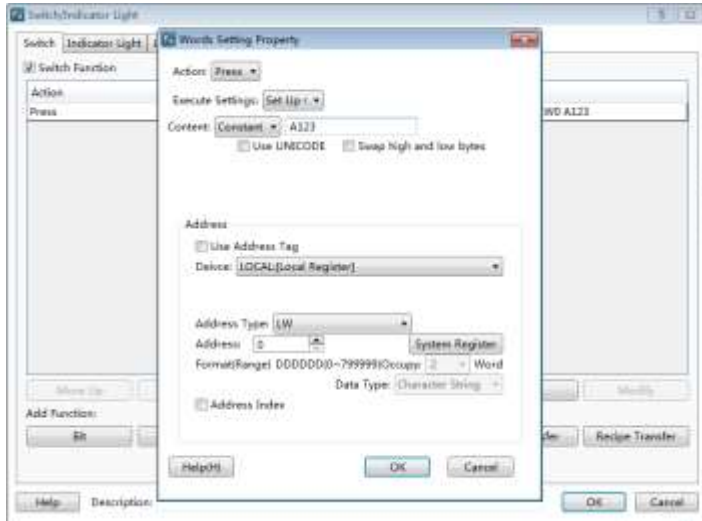

“Set Up Character Strings” has two optional attributes “Use UNICODE” and “Swap high and low bytes”. When “Use UNICODE” is checked, it means the character string written to registers is coded by UNICODE. The string is normally displayed only in “UNICODE”. If “Swap high and low bytes” is checked, the high and low bytes in the character string will be exchanged before written to the word register.

- Set Up Figures By Bit

This function has two modes, “Add” and “Subtract”. By this function, each bit of the value can be added or subtracted.

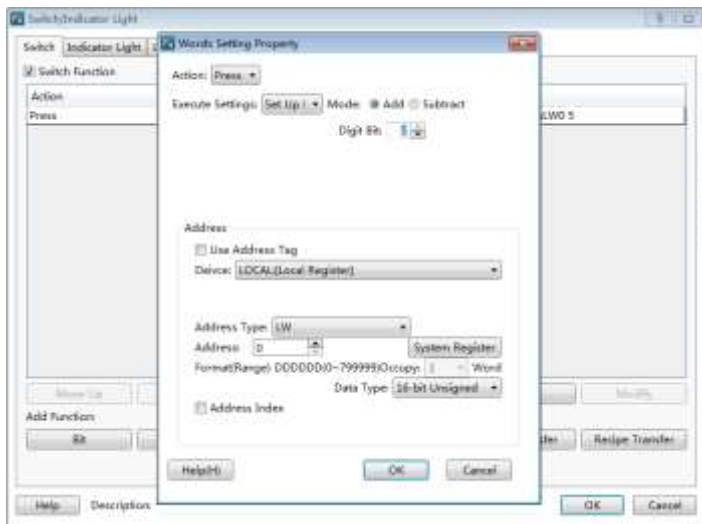

This function has an attribute “Date type”. It can be “16-bit Unsigned” or “32-bit unsigned number”. In other words, only unsigned single word and unsigned double word can use this function. If the data type is “16-bit unsigned number”, the value range is 0~65535. So the parameter of this function “Digit bit” can be 1~5. That means the number length is 1~5. “1” means units digit, “2” means tens digit, “3” means hundreds digit, “4” means thousands digit, and “5” means ten thousands digit. For example, if the “Digit bit” is 3 and the “Mode” is “Add”, it means the hundreds digit is operated for adding. If the hundreds digit of a register is 6 and when this component is pressed down, the hundreds bit will change into 7, and then into 8 if it is pressed

VEDA HCT User Manual

down again, and 9 again, 0 again, and 1 again, so the attribute of “Add” is similar to the “Looping” attribute. But, the “Add” or “Subtract” attribute of the “Set up Figures by Bit” function is only valid for one digit, and other digits are not changed.

For example, if “Digit bit” is 3, “Mode” is “Add”, and the current register value is 18668, the value will change into 18768 when the component is pressed down, 18868 when it is pressed down again, 18968 again, 18068 again, 18168 again. The maximum value of a single word is 65535. If the “Digit bit” is 5, the ten thousands digit will change in 0~5.

- Logic Operation

This function has four modes, “And”, “Or”, “Exclusive-or” and “Not”. The default mode is “Add”.

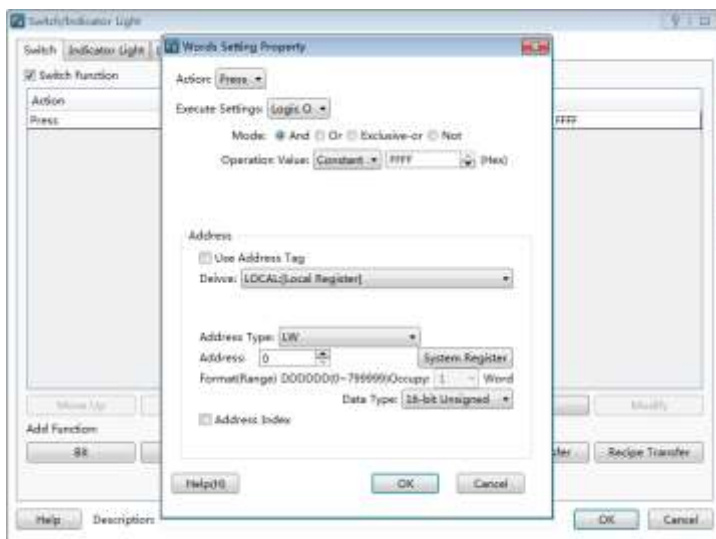

In the figure above, when the component is operated, the value in register LW0 will have a logic operation “And” with 0xFFFF. The logic result will be written to register LW0. The operations of other three modes are similar to “And” mode but the logic operation.

The attribute “Operation Value” can be “Constant” or “Variables”. The default is “Constant” and the data format is hexadecimal. It can be a variable, but the data type must comply with the register data type.

The attribute “Data Type” for logic operation can be “16-bit Unsigned”, “32-bit Unsigned”, “16-bit BCD” and “32-bit BCD”.

Special notice:

In all these functions for “Word Set”, the “Action” is “Press” in default. That means the operation will be executed correspondingly when the component is pressed down. The “Action” can also be “Release” but not for the function “Increase” and “Decrease”. That means the operation will be executed correspondingly when the component is released.

VEDA HCT User Manual

When use “Variables” for the “Word Set” function, the data type of “Variables” must comply with the data type of word register used. If not, the result may be incorrect.

4.6.1.3 Window Operation

- Action

The attribute “Action” of “Window Operation” can be “Press” or “Release”.

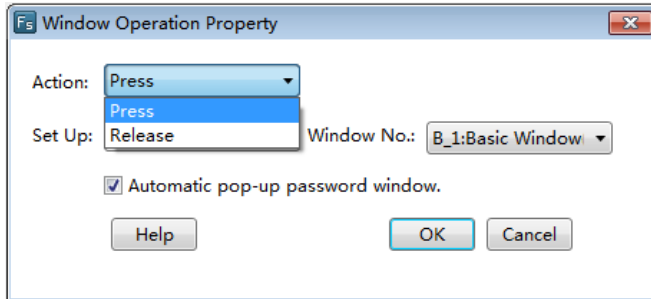

- Press

The corresponding keyboard function will be given out when the component is pressed down, and the macro instructions or system operation instructions will be executed.

- Release

The corresponding keyboard function will be given out when the component is released, and the macro instructions or system operation instructions will be executed.

- Set Up

The attribute “Set Up” of “Window operation” can be “Switch Window”, “Close Pop-up Window”, “Pop-up”, “Return To Previous Window”, “Window Control Bar” or “Return to the main window (HOME)”.

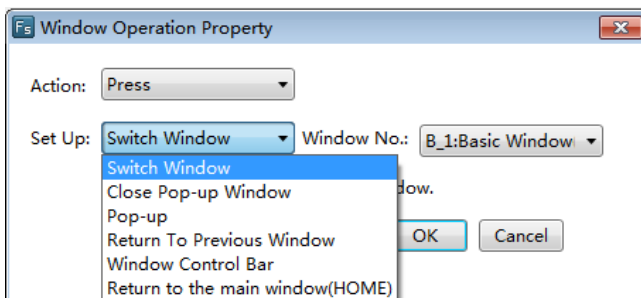

- Switch Window

Close the current window and switch to a designated window.

- Close Pop-up Window

Put the button on the pop-up window, click to close it.

- Pop-up

VEDA HCT User Manual

Pop up a designated window.

➤ Return To Previous Window

Close the current window and open the window opened last time.

➤ Window Control Bar

Put the component on the pop-up window, press, hold and drag to modify the pop-up window position.

➤ Return to the main window (HOME)

Close the current window and open the preset main window. The main window can be set by the menu command “Setup -> System Setting -> General Setting”.

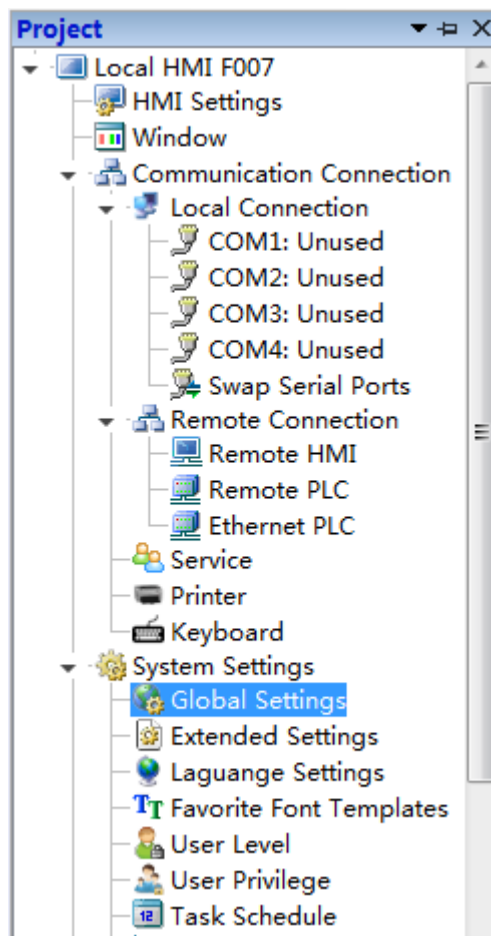
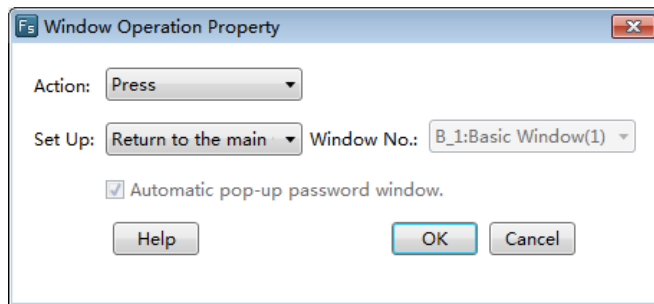

VEDA HCT User Manual

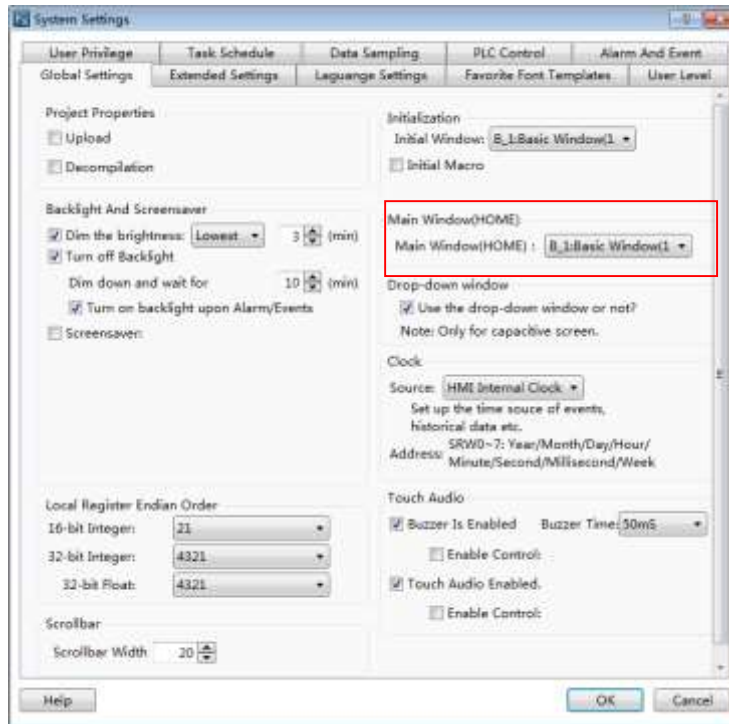

- Automatic pop-up password window

If “Automatic pop-up password window” is checked and when the window operation is switched to a window in a higher password or authority level, the window to enter password will pop up automatically.

4.6.1.4 Function Key

The “Function Key” component provides component executing action, keyboard function, executing macro instructions, and system operation functions.

- Action

The attribute “Action” of “Function Key” can be “Press” or “Release”.



- Press

The corresponding keyboard function will be given out when the element is pressed down, and the macro instructions or system operation instructions will be executed.

- Release

The corresponding keyboard function will be given out when the component is released, and the macro instructions or system operation instructions will be executed.

VEDA HCT User Manual

- Function Setting

The attribute “Function Setting” of the “Function Key” includes “Keyboard Function”, “Execute Macro”, “System Operation” and “Print”.

- Keyboard Function

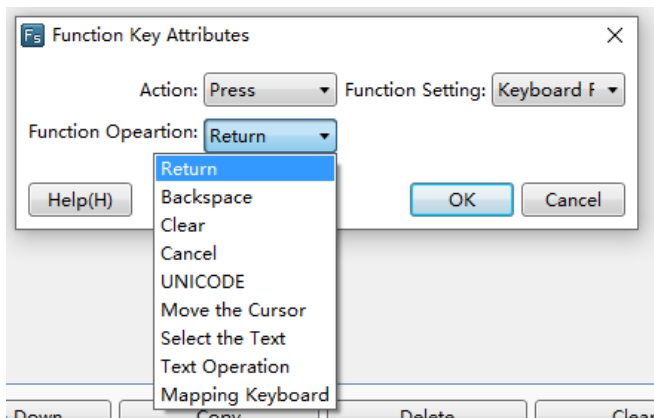

“Return”

It is the same to the “Enter” key on the keyboard.

“Backspace”

It is the same to the “Backspace” key on the keyboard.

“Clear”

Delete the current content which has been inputted for the component “Numeric Value Input” and “Character Input”.

“Cancel

Cancel the component operation of “Numeric Value Input” and “Character Input”.

“UNICODE”

Set the type of characters which inputted to the component “Character Input”. The characters can be number keys (0, 1, 2...), letters of an alphabet (a, b, c...), ASCII code or Unicode characters.

“Move the Cursor”

Move the cursor according to the set modes including up, down, left, right, row beginning, row end, first bit and last bit. This function is effective only for the input component.

“Select the Text”

VEDA HCT User Manual

Set the operation for the selected text content, including “Selection Begin” and “Selection End”. This function is effective only for the input component.

“Text Operation”

Set the operation for the text content, including “Copy”, “Cut” and “Paste”. This function is effective only for the input component.

“Mapping Keyboard”

When this function is activated, corresponding functions can be mapped to F1~F8 of HMI, including forward, backward, Esc, Enter, and so on. This function is effective only for some specified HMI.

➤ Execute Macro

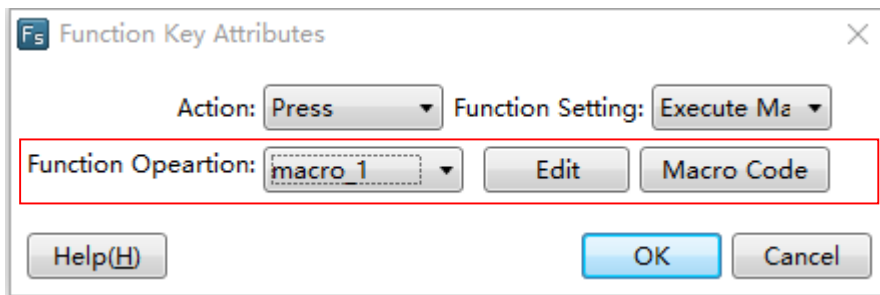

If this function is selected, the selected macro will be executed when the component is pressed down or released. The “Macro Instruction” dialog will pop up if you click the button “Macro Code” or “Edit”. You can select or create a macro here, or edit the current macro.

➤ System Operation

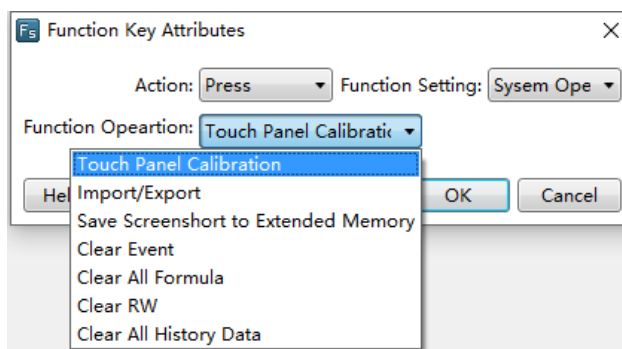

“Touch Panel Calibration”

By using this function, the user can enter the touch control calibrating window. Screen touch control calibration for HMI can be realized in this window.

“Import/Export”

VEDA HCT User Manual

When this function is selected, the project or prescription data can be imported or exported. This function must be used together with the file view box, and it only supports the HMI with USB HOST or SD card slot.

“Save Screenshot to Extended Memory”

When this function is selected, the touch screen picture can be captured and saved into an external memory device in the bmp format for printing or viewing HMI picture. And this function only supports the HMI with USB HOST or SD card slot.

“Clear Event”

This function can be used to clear warning events in groups.

“Clear All Formula”

This function can be used to clear all prescription data.

“Clear RW”

This function can be used to clear all RW data saved in power failure.

“Clear All History”

This function can be used to clear all history data. It can be used together with other switch components.

4.6.1.5 Data Transferring

The “Data Transferring” component can be used to transmit the data saved in one or more continuous addresses to another one or other more continuous addresses.

VEDA HCT User Manual

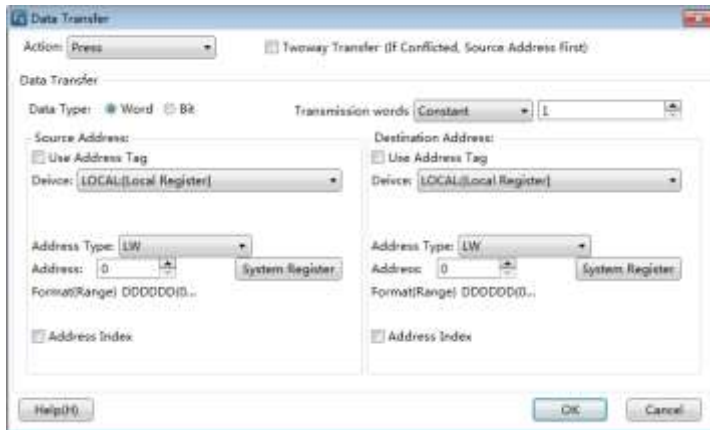

➤ Action

The attribute “Action” can be “Press” or “Release”. When “Press” is selected, data transmission will be started when the component is pressed down. When “Release” is selected, data transmission will be executed when the component is released.

➤ Data Type

The “Data Type” means the type of data to be transmitted. It can be “Bit” or “Word”.

➤ Transmission words

It means the number of data transmitted at one time. It can be set “Constant” or “Variable”. If set “Variable”, the register address must be designated. The maximum number of words transmitted in this software is 8192.

➤ Source Address

The “Source Address” means the first address of the data to be transmitted. The detailed can be seen in the [Detailed manual/General functions/Address editor/Standard Bit Address Input](#) or [Detailed manual/General functions/Address editor/Standard Byte Address Input](#).

➤ Destination address

The “Destination address” means the first address of data transmission target. The detailed can be seen in the [Detailed manual/General functions/Address editor/Standard Bit Address Input](#) or [Detailed manual/General functions/Address editor/Standard Byte Address Input](#).

4.6.1.6 Recipe Transmission

The “Recipe Transmission” component includes two transmission directions: “Download recipe to PLC” and “Upload recipe from PLC”. “Download recipe to PLC” means transmitting the content of the recipe file to the address of PLC. “Upload recipe from PLC” means transmitting data from the address of PLC to the recipe file.

VEDA HCT User Manual

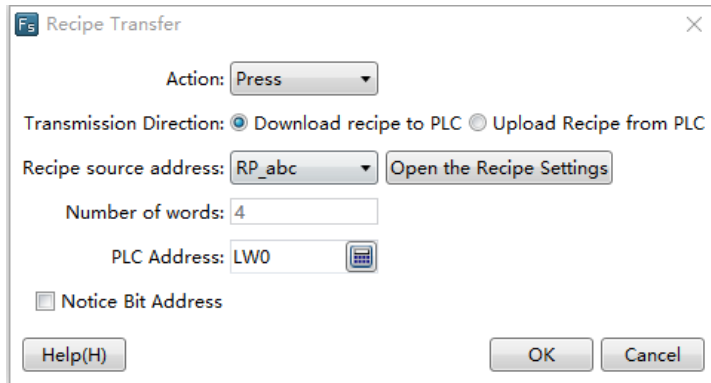

- Download recipe to PLC

It's the default setting for the "Transmission Direction".

- Upload Recipe from PLC

If the "Upload Recipe from PLC" is selected, the recipe uploading function will be activated.

The detailed operation of the recipe uploading can refer to the recipe downloading.

➤ Recipe source address

When no recipe file is created, the "Recipe source address" will be blank with a red exclamation mark. You can click the button "Open the Recipe Settings" to create recipe. After the recipe is created, you can select it in "Recipe source address" to download.

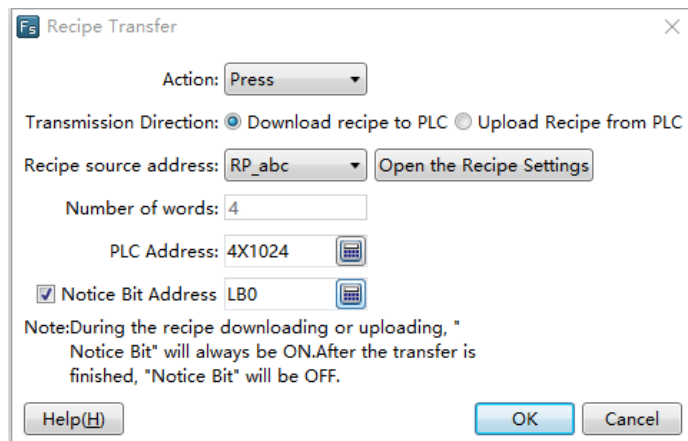

Notice:

The "Number of words" is determined by the recipe itself, and it always displays automatically.

➤ PLC Address

"PLC Address" means the target address for recipe file data transmission. It can be the address of PLC connected to HMI or an internal address of HMI. The detailed address editing method can be seen in: [Detailed manual/General functions/Address editor/ Standard Byte Address Input](#).

VEDA HCT User Manual

➤ Notice Bit Address

A bit address can be set here to monitor the recipe downloading state. The address editing method can be seen in: [Detailed manual/General functions/Address editor/Standard Bit Address Input](#). This bit address will be kept on during the recipe downloading or uploading, and it will be set to OFF after transmission.

4.6.2 Indicator Light

4.6.2.1 Bit Indicator Light

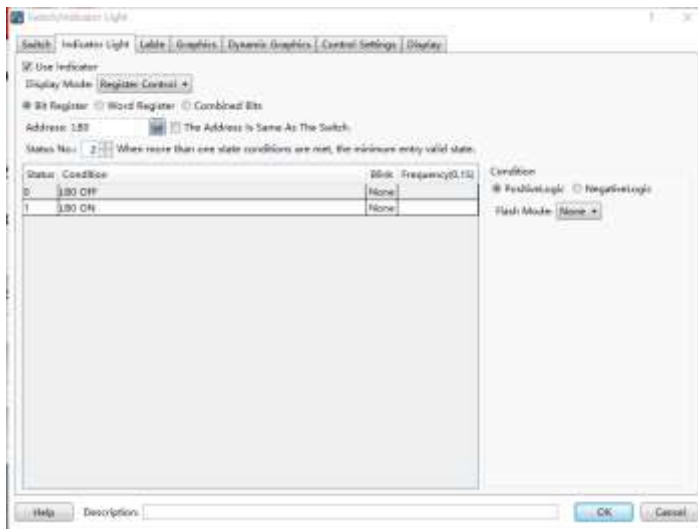

- Display Mode

The “Display Mode” can be “Register Control” or “Automatic looping”. The details are referred to: [Detailed manual/General functions/Drawing/Display Mode](#).

- Bit Register

The component is a bit indicator when “Bit Register” is selected. The method to input bit address can be seen in: [Detailed manual/General functions/Address editor/Standard Bit Address Input](#).

- Status No.

The status of a bit address can be ON or OFF. So it is 2 here in default and can not be modified.

- Condition

- Positive Logic

State 0 is OFF and state 1 is ON.

- Negative Logic

State 0 is ON and state 1 is OFF.

- Flash Mode

VEDA HCT User Manual

It includes three modes: “None”, “Blink Text” and “Blink Picture”. You can select each status in left table and then set the flash mode for the status selected.

- None

It means no flashing.

- Blink Text

Text can flash in a frequency.

- Blink Picture

Picture can flash in a frequency.

- Flash Freq.

Picture or text will flash in a designated frequency. The frequency can be a multiple of 0.1 second.

Detailed attribute information of the current bit indicator light can be seen in the table at the left bottom.

4.6.2.2 Word Indicator Light

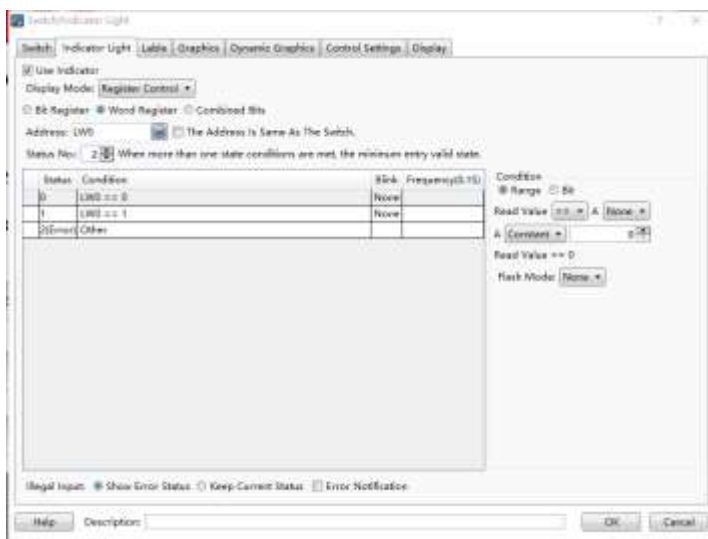

- Display Mode

The “Display Mode” can be “Register Control” or “Automatic looping”.

- Word Register

The component is a word indicator when “Word Register” is selected. The method to input bit address can be seen in: [Detailed manual/General functions/Address editor/Standard Byte Address Input](#).

- Status No.

VEDA HCT User Manual

The range of the status number is 1~256. Each status corresponds to the value of the word address. When many statuses satisfy the condition at the same time, only the status with the minimum value will be effective.

- Condition

- Range

The status content (value) will be determined according to the comparison and logic operation result of the word address value. The comparison operation includes ">", "<", ">=", "<=", "==" and "!=". The logic operation can be "AND", "OR" or "None".

Condition

Range Bit

Read Value == A AND

Read Value == B

A Constant 0

B Constant 0

Read Value == 0 AND == 0

Flash Mode: None

- Bit

Text or picture can be displayed according to the state of one bit of the word address, e.g.: bit LW0.1 of address LW0.

“Positive Logic” means that State 0 is OFF and state 1 is ON.

“Negative Logic” means that State 0 is ON and state 1 is OFF.

- Flash Mode

It includes three modes: “None”, “Blink Text” and “Blink Picture”. You can select each status in left table and then set the flash mode for the status selected.

- None

It means no flashing.

- Blink Text

Text can flash in a frequency.

- Blink Picture

Picture can flash in a frequency.

- Flash Freq.

VEDA HCT User Manual

Picture or text will flash in a designated frequency. The frequency can be a multiple of 0.1 second.

Detailed attribute information of the current word indicator light can be seen in the table at the left bottom.

Status	Condition	Tag Content	Blink	Frequen
0	LW0 Bit0 OFF		Text	5
1	LW0 == 1		Picture	5
2(Error)	Other		None	

Illegal Input: Show Error Status Keep Current Status

Error Notification 

- Illegal Input

The value of word address doesn't satisfy the condition preset.

- Show Error Status

The indicator displays the “Error” status when illegal input happened. That is the last status displayed in the table.

- Keep Current status

The indicator keeps the current status when illegal input happened.

- Error Notification

You can select a bit address here. It will be set to ON if the word address value doesn't satisfy with the condition. It will be set to OFF when the condition is satisfied.

4.6.2.3 Multi Bit Combination Indicator Light

VEDA HCT User Manual

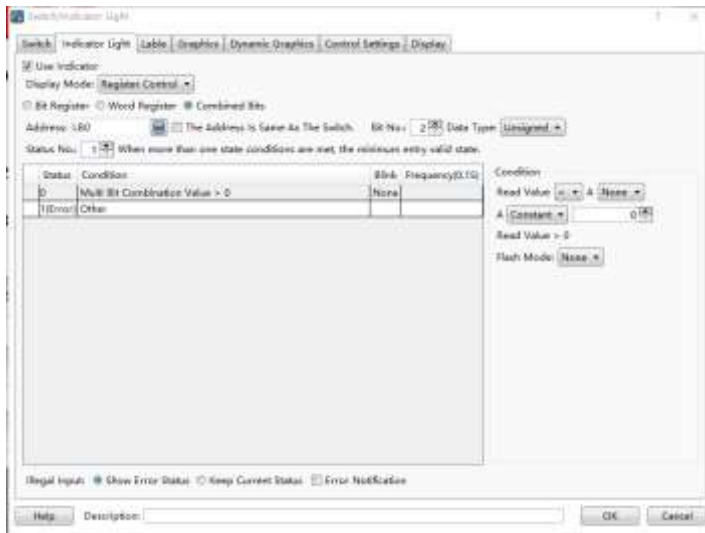

- Display Mode

The “Display Mode” can be “Register Control” or “Automatic looping”.

- Combined Bits

The status displayed is determined by a multi bit combination condition.

- Bit No.

The condition can be a combination of 2~32 bits. The “Bit No.” means the number of bits.

- Data Type

- Unsigned

If the number of bits is n, the combination value will be $0 \sim 2^n - 1$.

- Signed

If the number of bit is n, the combination value will be $-2^{n-1} \sim 2^{n-1} - 1$.

- Starting Address

The starting address is closely associated to the number of bits. For example, if the starting address is LB0 and the number of bits is 2, a combination will be formed. LB1 will be the high bit and LB0 will be the low bit. The range of 2 bits combination value will be $0 \sim 3$ if the data type is unsigned. The range of 2 bits combination value will be $-2 \sim 1$ if the data type is signed.

- Status No.

The range of the status number is $1 \sim 256$. Each status corresponds to the value of the word address. When many statuses satisfy the condition at the same time, only the status with the minimum value will be effective.

- Condition

- Range

VEDA HCT User Manual

The status content (value) will be determined according to the value of the combined bits. The comparison operation includes “>”, “<”, “>=”, “<=”, “==” and “!=”. The logic operation can be “AND”, “OR” or “None”.

The screenshot shows a configuration window titled "Condition". It contains the following elements:

- "Read Value >" followed by a dropdown menu set to "A" and a logic operation dropdown menu set to "AND".
- "Read Value <" followed by a dropdown menu set to "B".
- "A" followed by a dropdown menu set to "Constant" and a numeric input field containing "0".
- "B" followed by a dropdown menu set to "Constant" and a numeric input field containing "0".
- A summary text: "Read Value > 0 AND < 0".
- "Flash Mode:" followed by a dropdown menu set to "None".

- Flash Mode

It includes three modes: “None”, “Blink Text” and “Blink Picture”. You can select each status in left table and then set the flash mode for the status selected.

- None

It means no flashing.

- Blink Text

Text can flash in a frequency.

- Blink Picture

Picture can flash in a frequency.

- Flash Freq.

Picture or text will flash in a designated frequency. The frequency can be a multiple of 0.1 second.

Detailed attribute information of the current component can be seen in the table at the left bottom.

VEDA HCT User Manual

Status	Condition	Tag	Blink	Frec
0	Multi Bit Combination Value == 1		None	
1	Multi Bit Combination Value == 2		None	
2	Multi Bit Combination Value == 3		None	
3(Error)	Other		None	

Illegal Input: Show Error Status Keep Current Status

Error Notification LBO 

- **Illegal Input**

The multi bit combination value doesn't satisfy the condition preset.

- **Show Error Status**

The indicator displays the “Error” status when illegal input happened. That is the last status displayed in the table.

- **Keep Current status**

The indicator keeps the current status when illegal input happened.

- **Error Notification**

You can select a bit address here. It will be set to ON if the multi bit combination value doesn't satisfy the condition. It will be set to OFF when the condition is satisfied.

4.6.2.4 Display Mode

You can find the “Display Mode” if you check the “Use Indicator” in the property TAB of “Indicator Light”. The display modes include “Register Control” and “Automatic looping”.

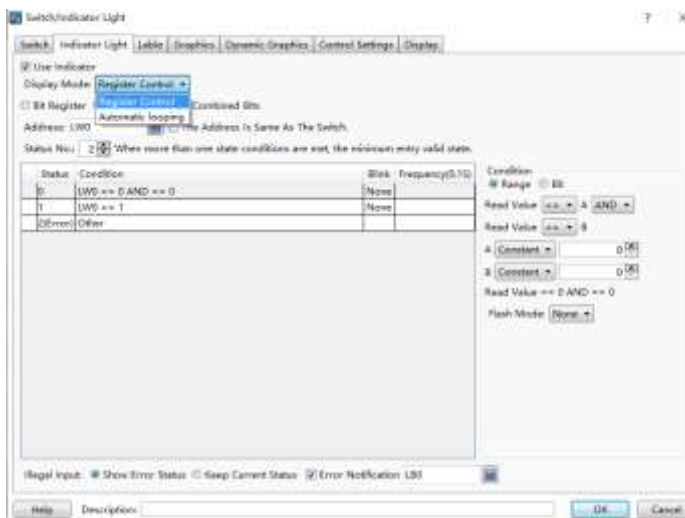

VEDA HCT User Manual

1 Register mode

The “Register Control” mode can be Bit Registers, Word Registers or Combined Bits.

2 Automatic looping

All the status will be cycled to display according to the specified frequency if the display mode is “Automatic looping”. The unit of frequency is 100 milliseconds. The setting is shown as below.



4.6.3 Numeric Value and Character Display

4.6.3.1 Numeric Value Display

4.6.3.1.1 General

- Operation Attribute

The “Operation Attribute” includes four operation types: “Numeric Display”, “Numeric Input”, “Character Display” and “Character Input”. The operation type of this current component can be modified here. It is highly efficient for the project modifying and maintaining.

VEDA HCT User Manual

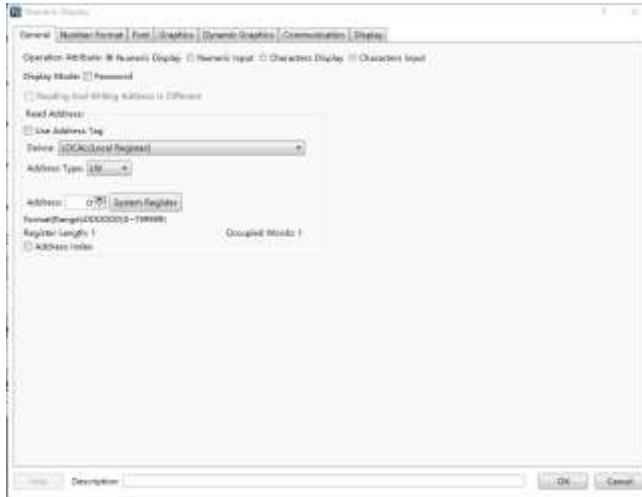

- Password

When the “Password” is checked, “*” will be displayed in the component (See the figure below). It is always used for the numeric value input component. The numeric value display component is not used generally.

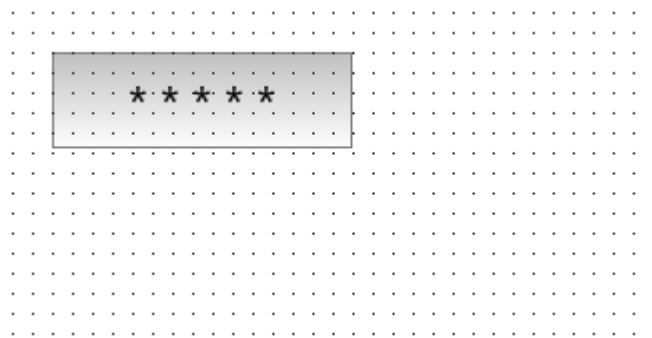

- Read Address

- Use Address Tag

VEDA HCT User Manual

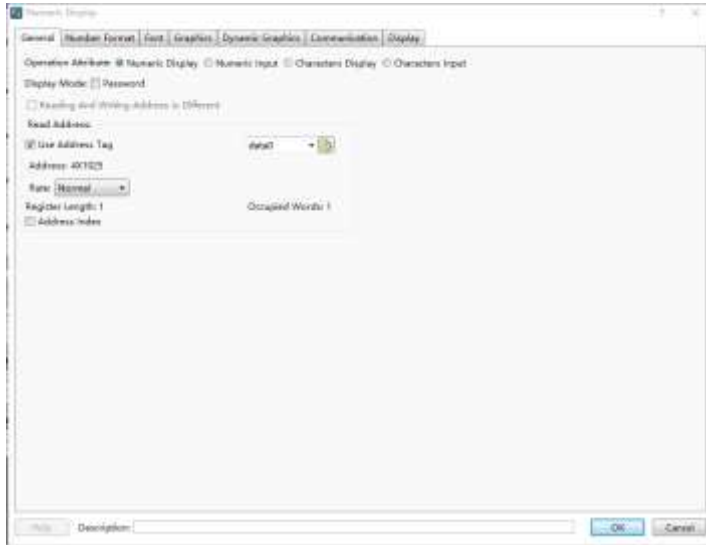

When this function is checked, variables in the address tag library can be directly linked by the component (See address tag library details in: [Detailed manual/Library/Address Tag Library](#)). The address tag library can be used to improve the project maintaining efficiency. If many components in the project are linked to a same variable in the address tag library and this address need to be modified, it is only necessary to modify the variable address linked in the tag library without modifying each component.

- Address setting

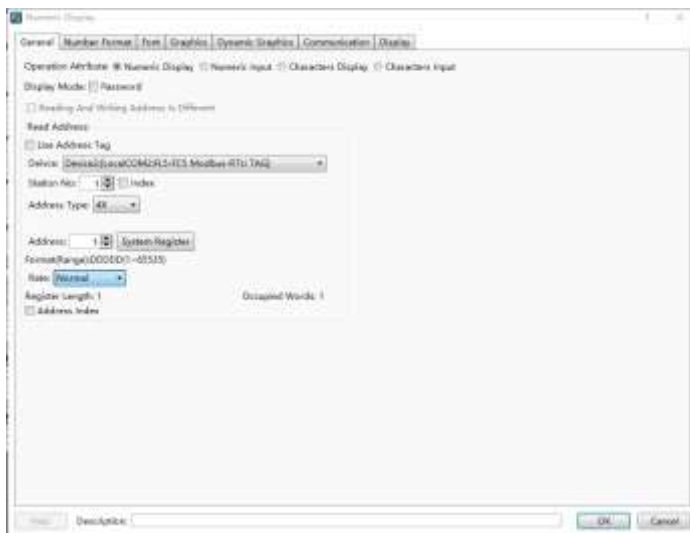

The address setting includes the attributes : “Device”, “Address Type”, “Address”, “Format (Range)”, “Address Index”, and so on. Please see: [Detailed manual/ General functions/ Address editor/ Standard Byte Address Input](#).

4.6.3.1.2 Number Format

VEDA HCT User Manual

- Data Type

The “Data Type” can be “16-bit Signed”, “16-bit Unsigned”, “32-bit Signed”, “32-bit Unsigned”, “16-bit BCD”, “32-bit BCD”, “16-bit Hexadecimal”, “32-bit Hexadecimal”, “16-bit Binary”, “32-bit Binary” or “Single precision floating point number”.

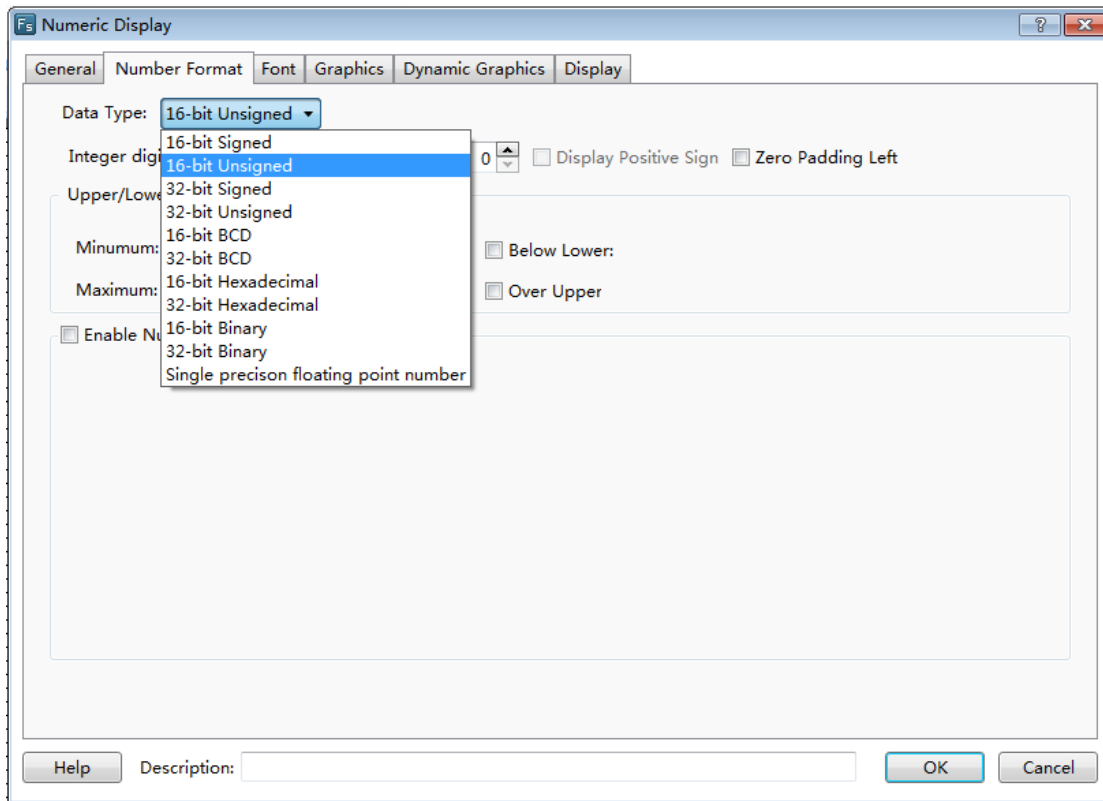

- Data setting

The “Data setting” includes “Integer digits”, “Decimal Point”, “Display Positive Sign” and “Zero Padding Left”.

VEDA HCT User Manual

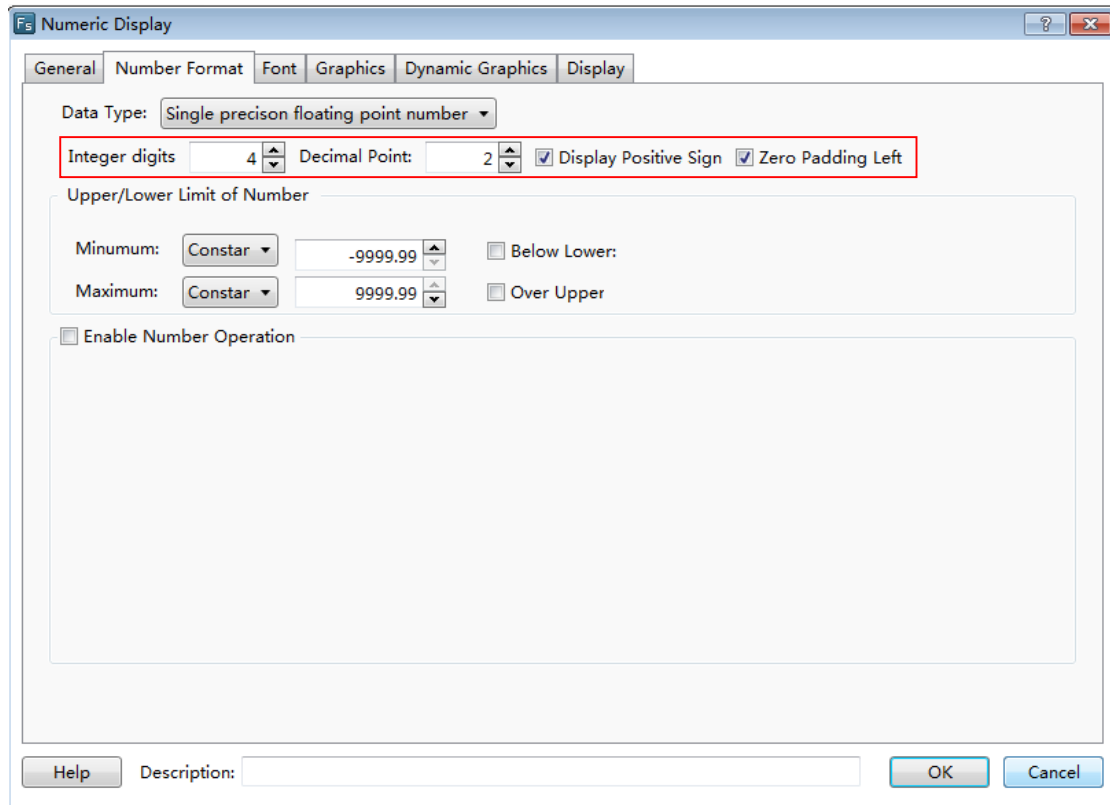

The “Integer digits” means the integer digit number of the data. The “Decimal Point” means the decimal digit number of the data.

Note: when the data type is an integer and the decimal bit is not zero, the value displayed will reduce to satisfy the decimal digit number. For example, if the data is an integer “55” and two decimal bits are set, the value displayed will be “0.55”. In fact, only the value and the type of the data displayed can be modified by this function. The actual value and the actual type are not modified. It is still the integer “55”.

- Upper/Lower Limit of Number

VEDA HCT User Manual

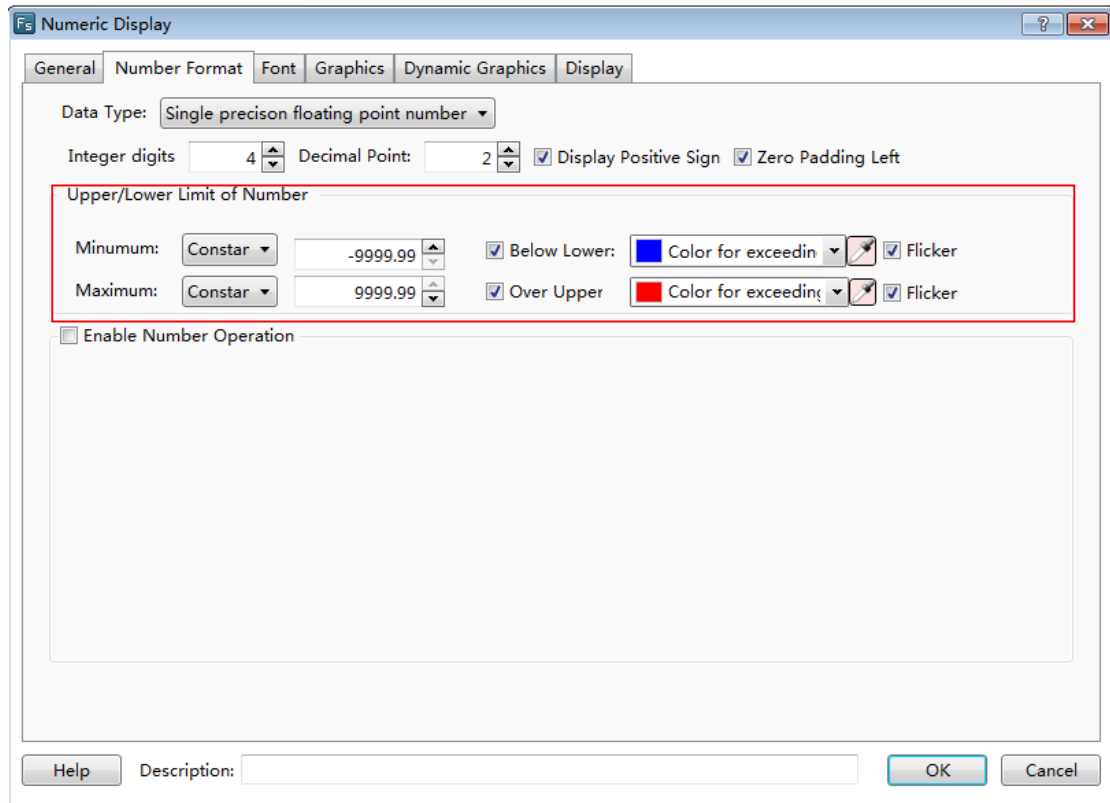

You can set the data upper limit in “Minimum” and the data lower limit in “Maximum”. And you can set the font color of the data beyond the limit. When the “Flicker” is checked, the text will flash when the data is less than the lower limit or greater than the upper limit.

- Enable Number Operation
- Proportion convert

VEDA HCT User Manual

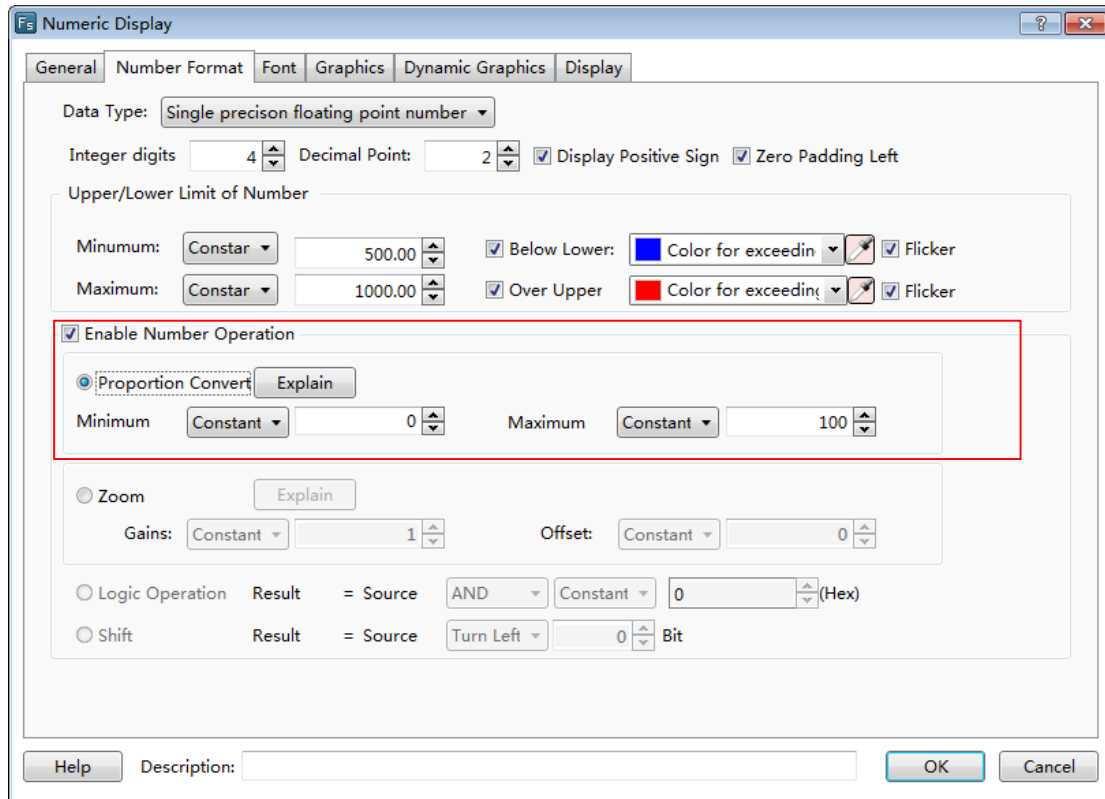

When the function of “Proportion Convert” is activated, the value displayed will be the result after proportional conversion. The proportional conversion formula is displayed when you click the button “Explain”.

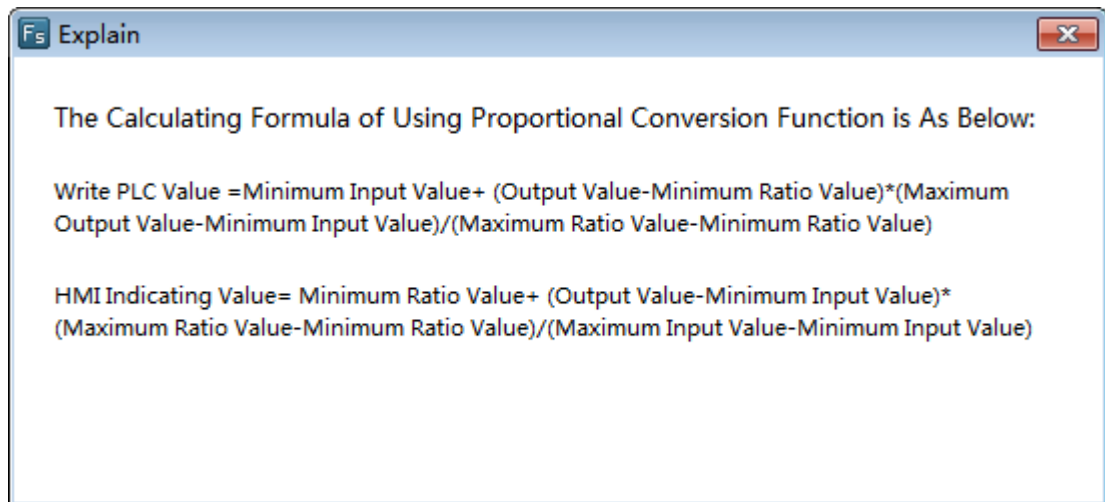

➤ Zoom

VEDA HCT User Manual

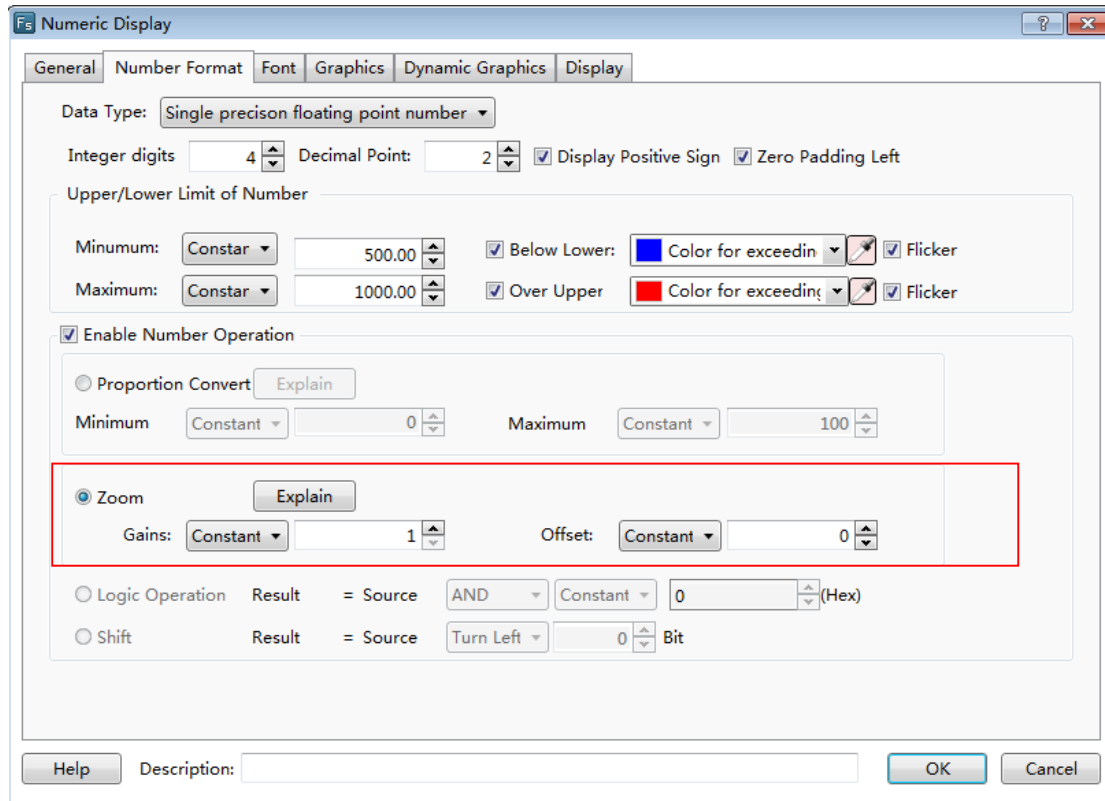

When the function of “Zoom” is selected, the value displayed will be the result after zooming conversion. The zooming conversion formula is displayed when you click the button “Explain”.

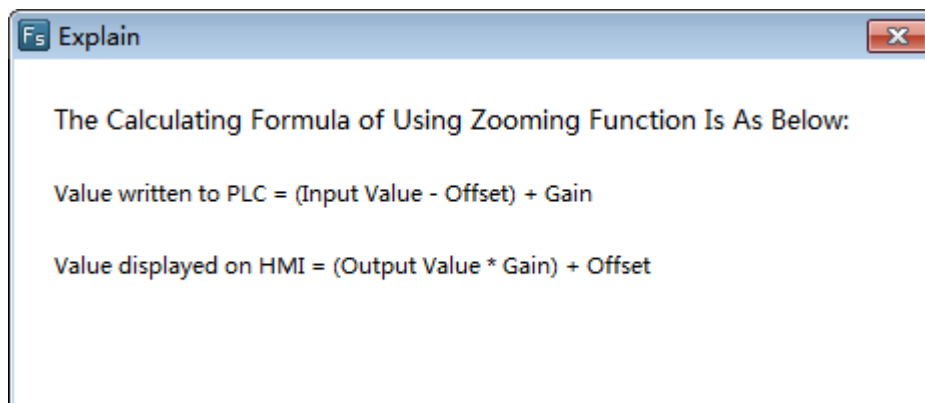

➤ Logic Operation

VEDA HCT User Manual

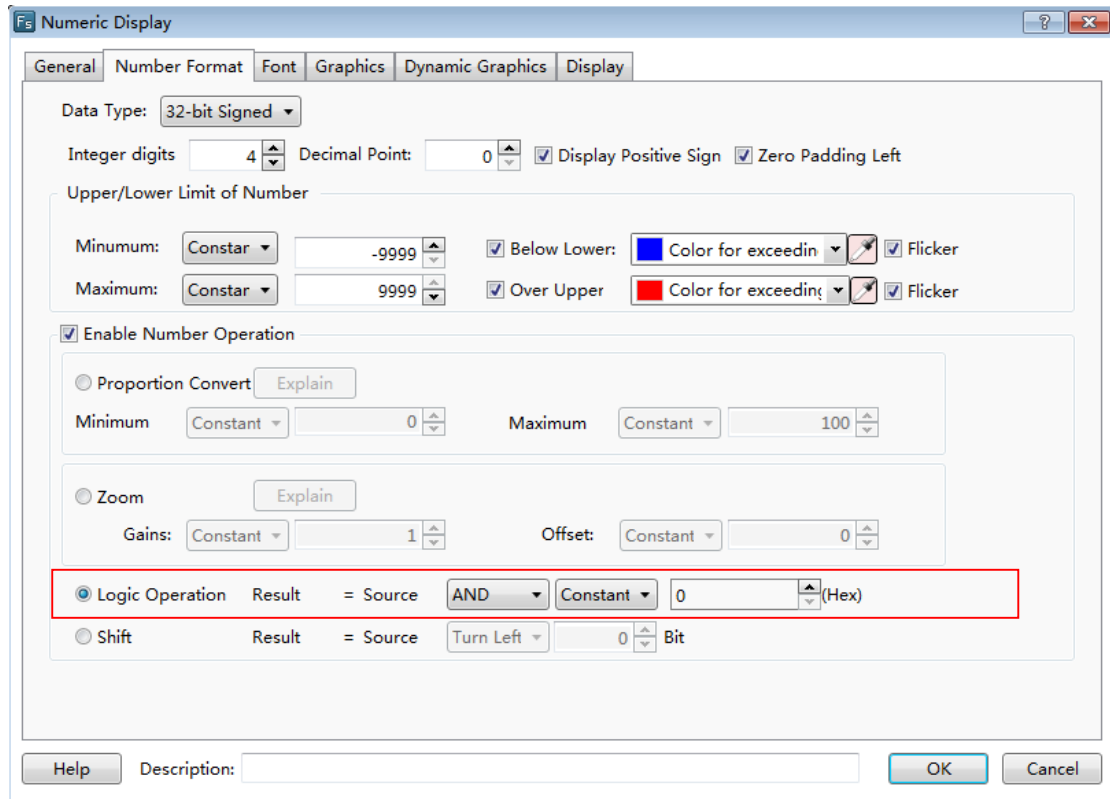

The data can be logically operated by the component which the logic operation can be “And”, “Or” or “Exclusive or”. And the result of logic operation will be displayed.

➤ Shift

VEDA HCT User Manual

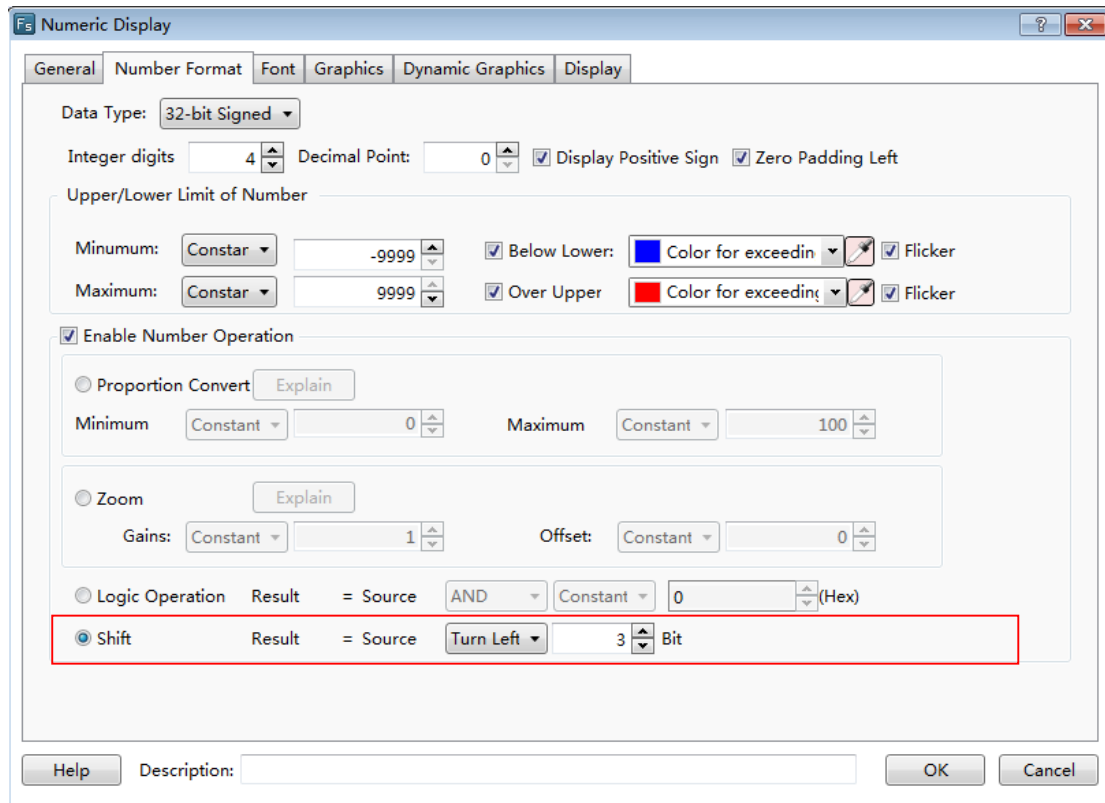

The data can be shifted left or right by the component. And the result of shifting operation will be displayed.

4.6.3.1.3Font

The detailed font setting can be seen: [Detailed manual/ General functions/ Drawing/ Font Settings](#).

4.6.3.1.4Graphics

The detailed graphics setting can be seen: [Detailed manual/ General functions/ Drawing/ Graphic edit](#).

4.6.3.1.5Dynamic Graphics

The detailed graphics setting can be seen: [Detailed manual/ General functions/ Drawing/ Dynamic Graphics](#).

4.6.3.1.6Display

The detailed display setting can be seen: [Detailed manual/ General functions/ Drawing/ Display](#).

VEDA HCT User Manual

4.6.3.2 Numeric Value Input

The attributes setting of the “Numeric Value Input” component is generally same to the “Numeric Value Display” component. The differences are detailed as below.

4.6.3.2.1 General

- Password

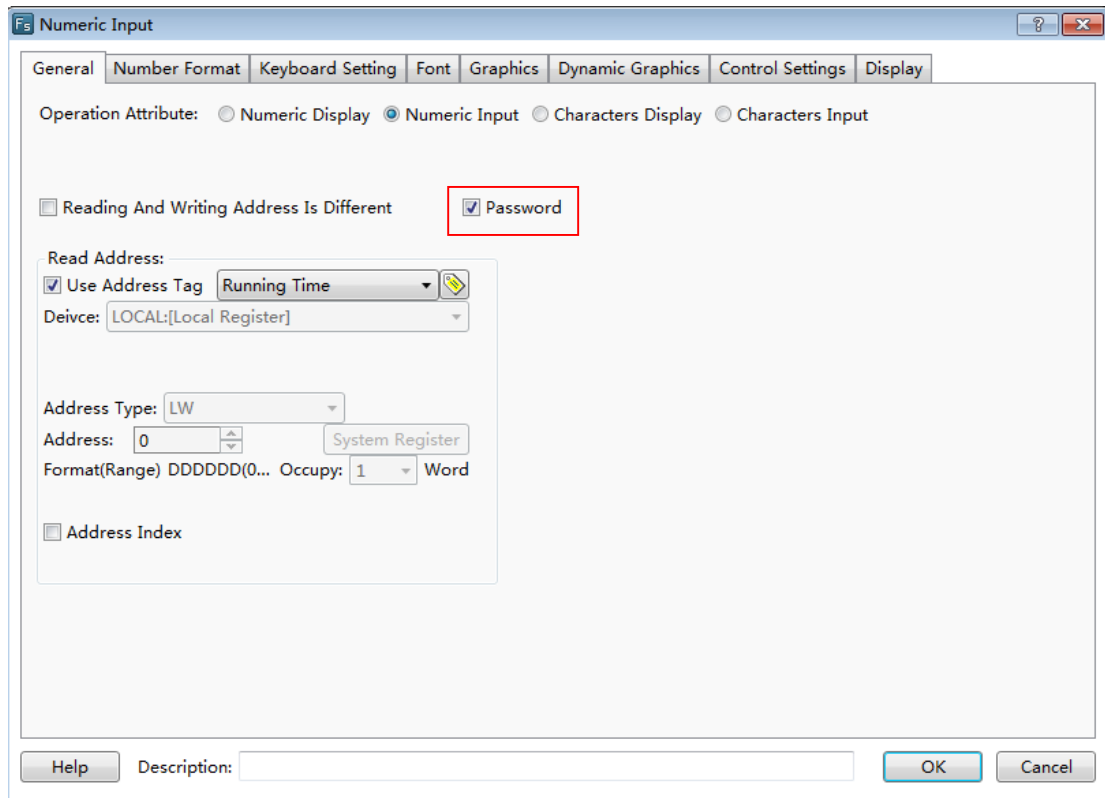

When the “Password” is checked, “*” will be displayed in the component (See the figure below). It can be checked if the current component is used to input the password.

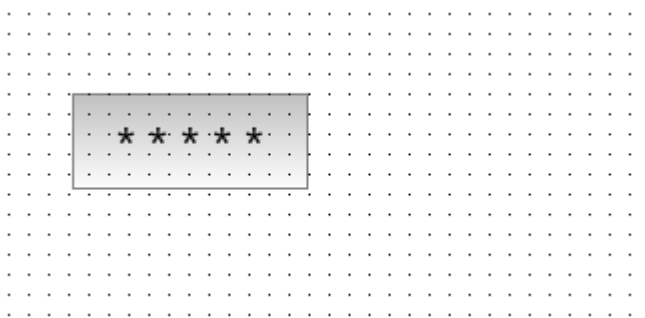

- Reading Address” and “Writing Address

VEDA HCT User Manual

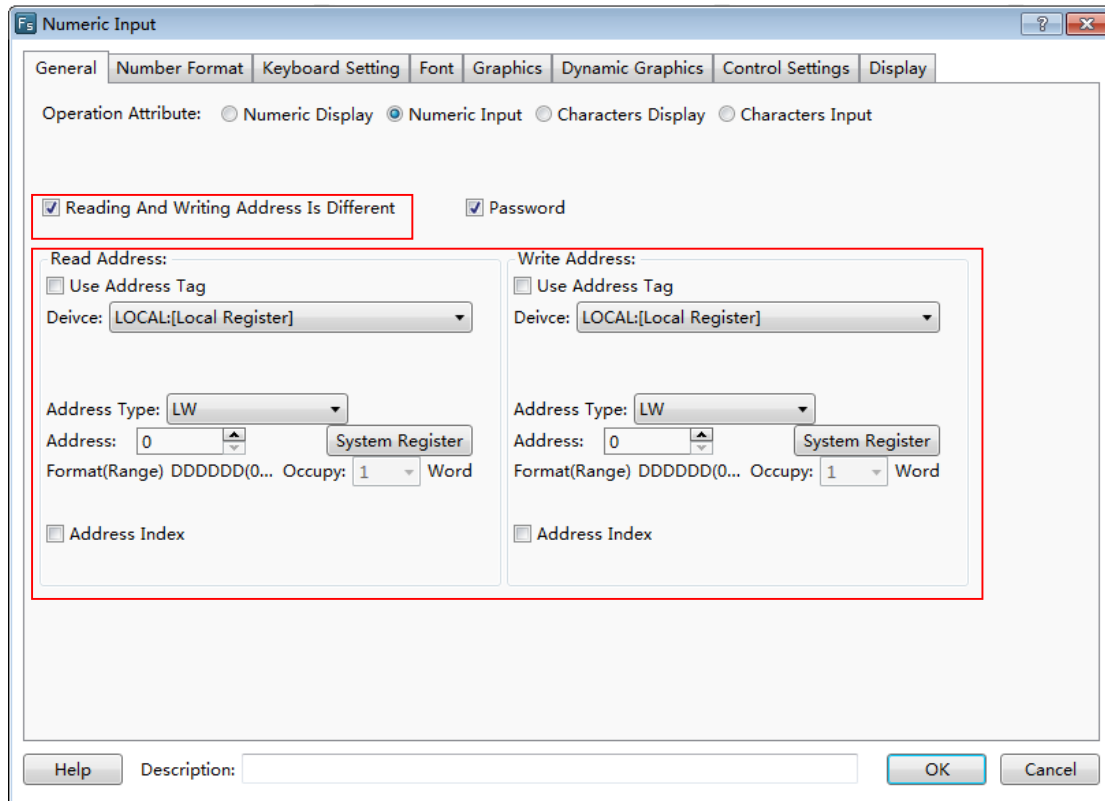

The numeric value input component is integrated with functions of reading data from an address and writing data to an address. When the “Reading And Writing Address Is Different” is not checked, the using method is same to the “Numeric Value Display” component. When the “Reading And Writing Address Is Different” is checked, different address can be set in the “Read Address” and in the “Write Address”.

4.6.3.2 Keyboard Setting

See detailed functions in: [Detailed manual/ General functions/ Drawing/ Keyboard setting.](#)

4.6.3.3 Character Display

4.6.3.3.1 General

- Operating Attribute

VEDA HCT User Manual

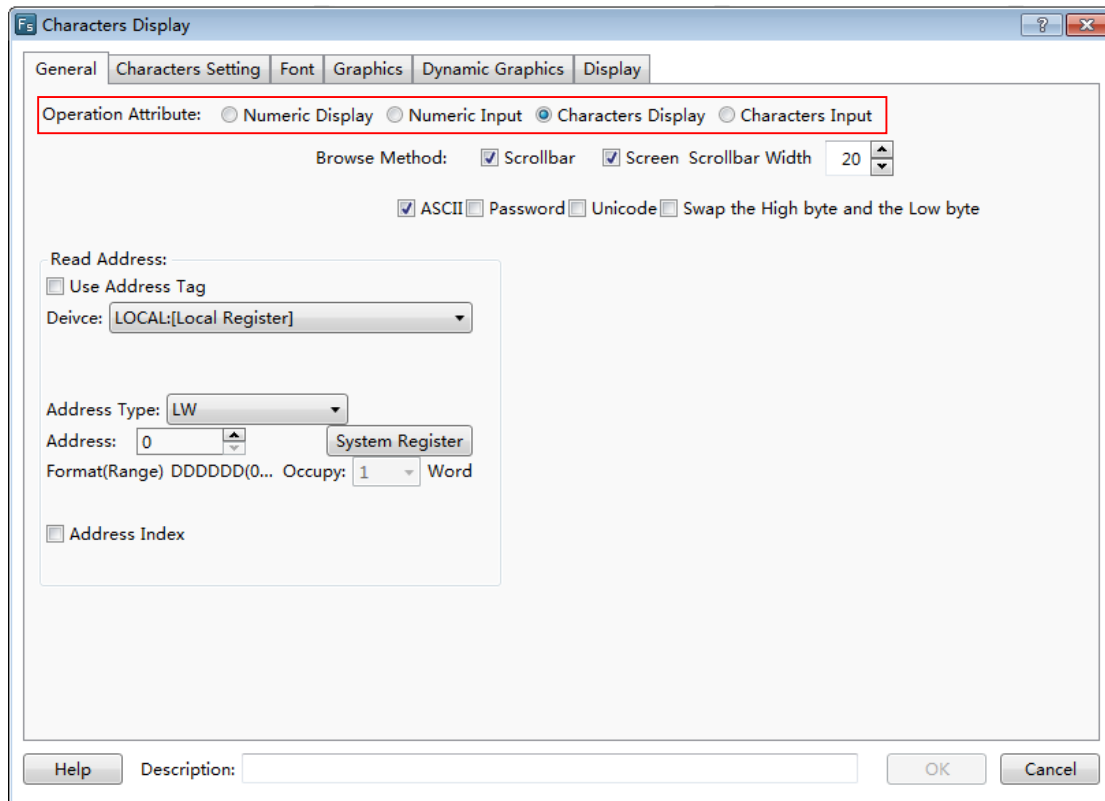

The “Operation Attribute” includes four operation types: “Numeric Display”, “Numeric Input”, “Character Display” and “Character Input”. If you want the current Character Display component change to the Character Input component or Numeric component, you can modify it here. It is highly efficient for the project modifying and maintaining.

- Browse Method

The “Browse Method” includes “Scrollbar” and “Screen”. You can select the “Scrollbar” or the “Screen” or both ways to browse the content of the current character component. The scrollbar width can be freely set. The “Screen” browse method is only effective for a capacitive screen.

- Display Mode

VEDA HCT User Manual

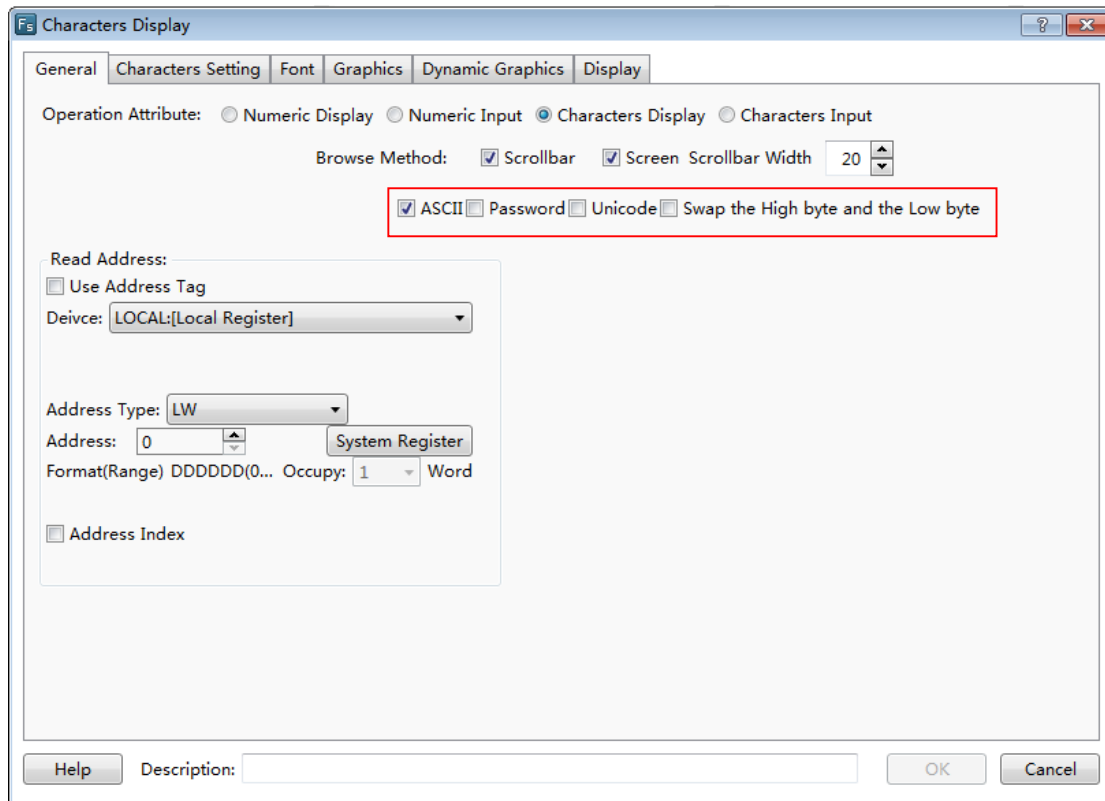

- ASCII

If it is checked, characters will be displayed in ASCII format. In this format, only ASCII characters will be displayed, including numbers, symbols and English letters. Chinese characters are not supported to display.

- Password

If it is checked, characters will be displayed in “*” mode.

- Unicode

If it is checked, characters will be displayed in UNICODE. In the UNICODE mode, each Chinese character or English letter will occupy one character (two bytes).

- Swap the High byte and the Low byte

After the “ASCII” is checked, you can select the function “Swap the High byte and the Low byte”.

- Read Address

- Use Address Tag

VEDA HCT User Manual

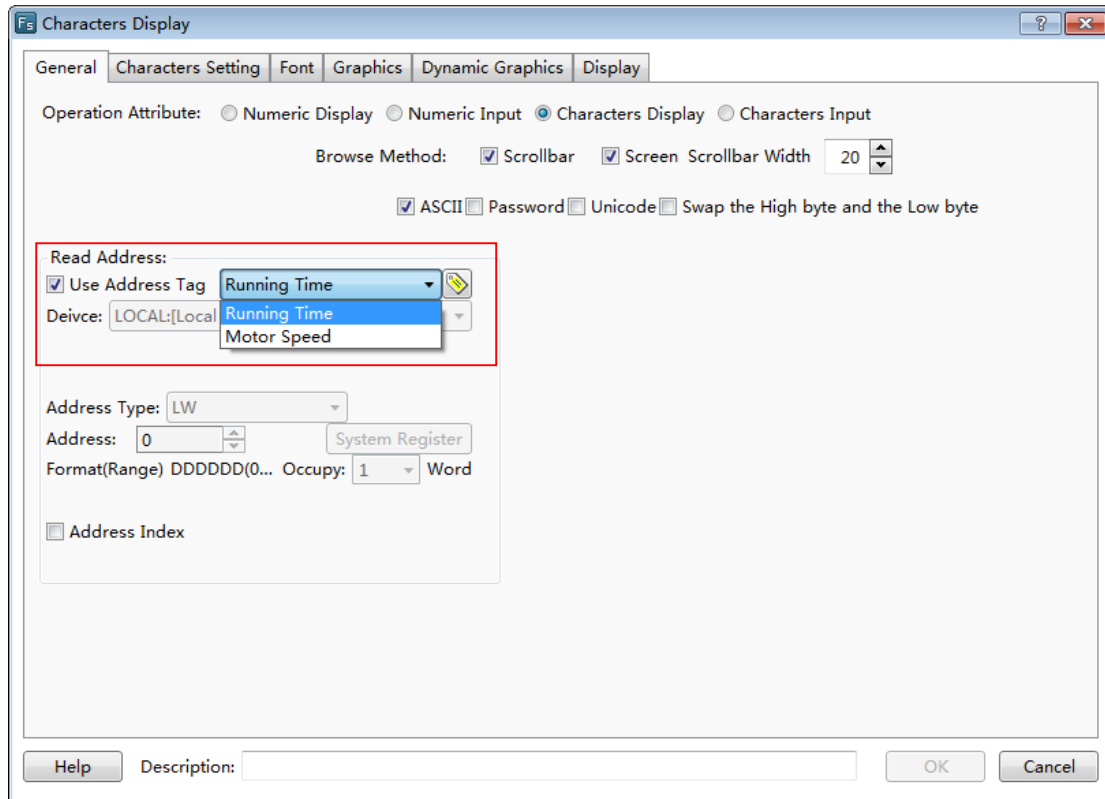

When this function is checked, variables in the address tag library can be directly linked by the component (See address tag library details in: [Detailed manual/Library/Address Tag Library](#)). The address tag library can be used to improve the project maintaining efficiency. If many components in the project are linked to a same variable in the address tag library and this address need to be modified, it is only necessary to modify the variable address linked in the tag library without modifying each component.

The address setting includes the attributes : “Device”, “Address Type”, “Address”, “Format (Range)”, “Address Index”, and so on. Please see: [Detailed manual/ General functions/ Address editor/ Standard Byte Address Input](#).

4.6.3.3 Characters setting

- Row Settings

VEDA HCT User Manual

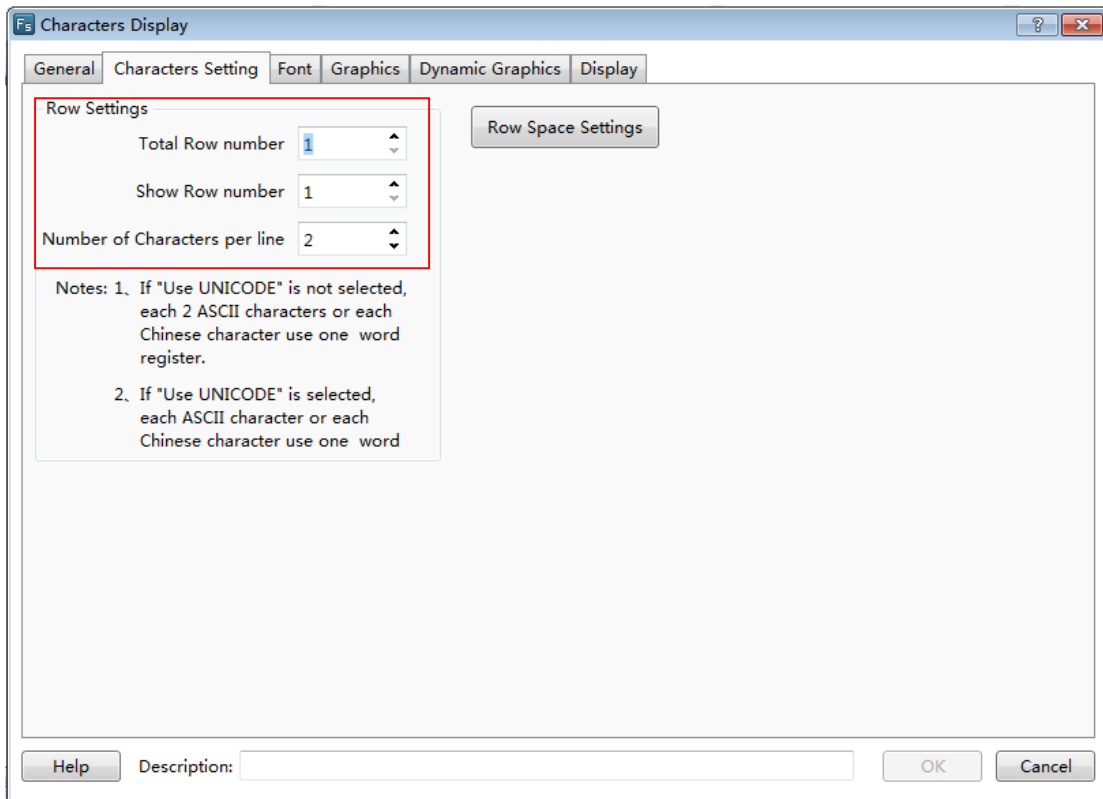

The "Row Settings" includes "Total Row number", "Show Row number" and "Number of Characters per line". The "Total Row number" means the number of the rows which the current character component contains. The "Show Row number" sets the number of rows displayed in the current character component. If the number of rows displayed is smaller than the number of total rows, a scrollbar will appear automatically.

- Row Space settings

VEDA HCT User Manual

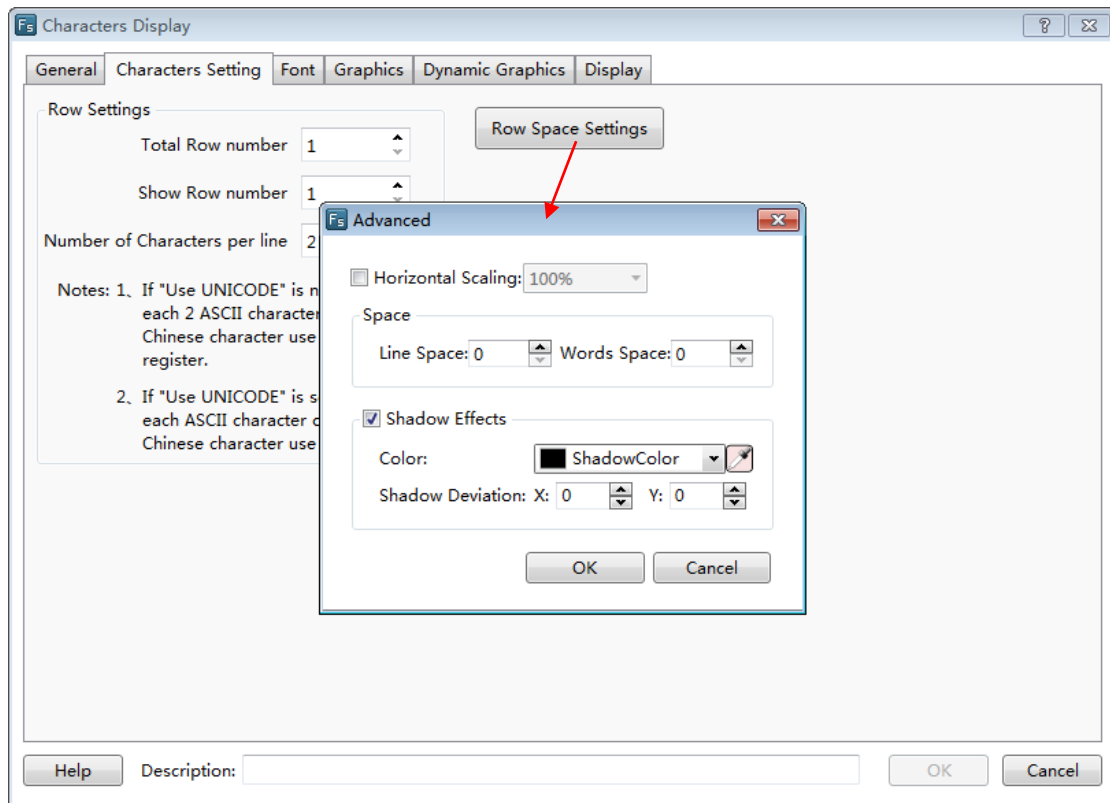

A dialog will pop up when you click the “Row Space Settings” button. You can set the attributes such as “Horizontal scaling”, “Line space”, “Words space”, “shadow Effects”, and so on.

4.6.3.3.3Font

See detailed font setting in: [Detailed manual/ General functions/ Drawing/ Font settings.](#)

4.6.3.3.4Graphics

See detailed Graphics setting in: [Detailed manual/General functions/Drawing/Graphic edit.](#)

4.6.3.3.5Dynamic Graphics

See detailed Dynamic Graphics setting in: [Detailed manual/ General functions/ Drawing/ Dynamic Graphics.](#)

4.6.3.3.6Display

See detailed display setting in: [Detailed manual/ General functions/ Drawing/Display.](#)

VEDA HCT User Manual

4.6.3.4 Character Input

4.6.3.4.1 General

- Operation Attribute

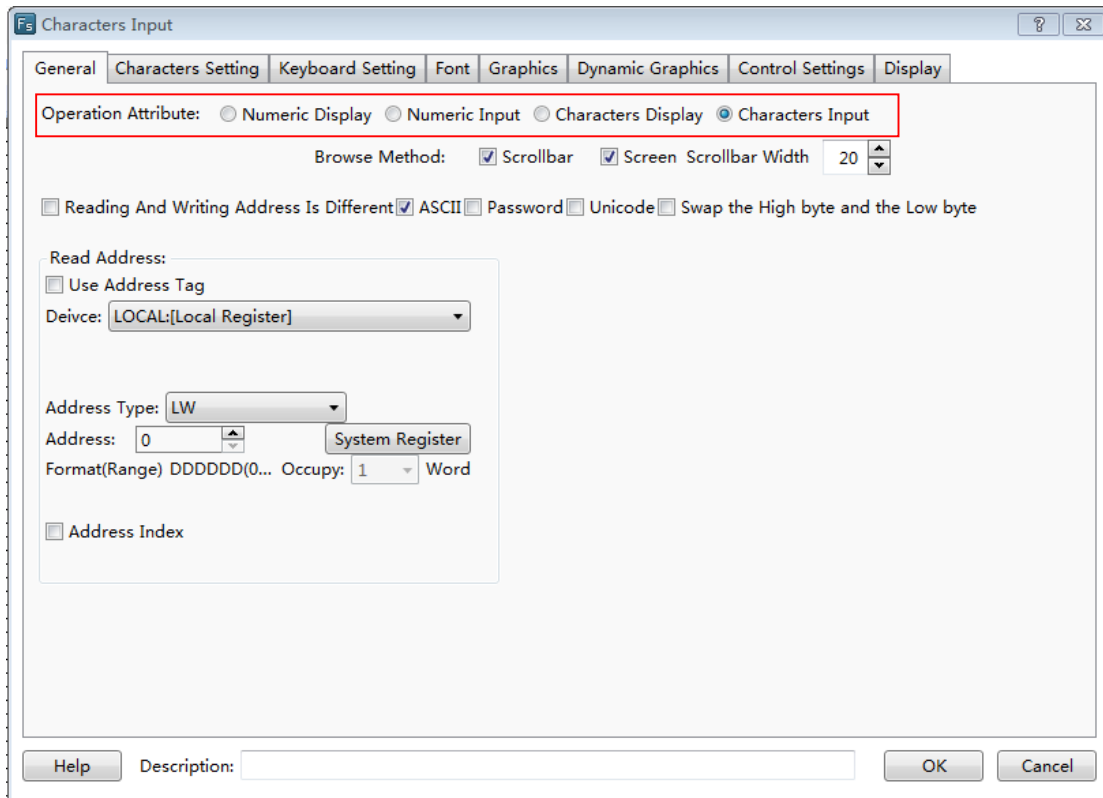

The “Operation Attribute” includes four operation types: “Numeric Display”, “Numeric Input”, “Character Display” and “Character Input”. If you want the current Character Input component change to the Character Display component or Numeric component, you can modify it here. It is highly efficient for the project modifying and maintaining.

- Browse Method

The “Browse Method” includes “Scrollbar” and “Screen”. You can select the “Scrollbar” or the “Screen” or both ways to browse the content of the current character component. The scrollbar width can be freely set. The “Screen” browse method is only effective for a capacitive screen.

- Display Mode

VEDA HCT User Manual

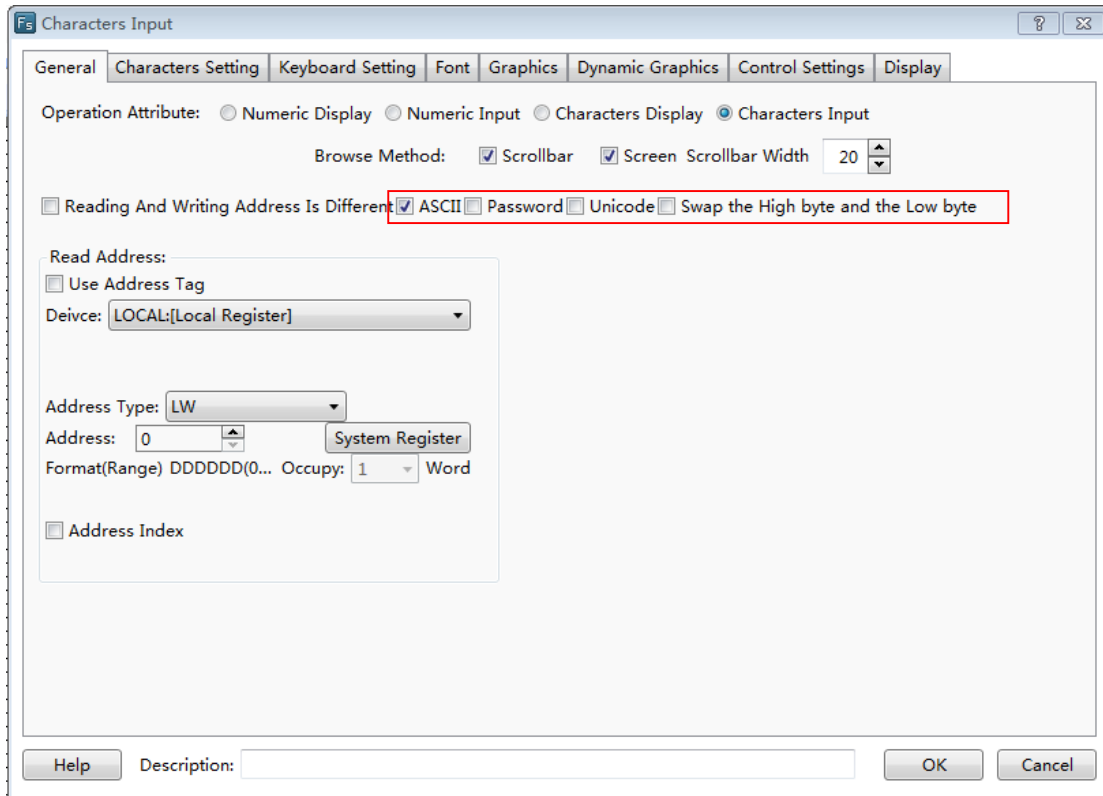

➤ ASCII

If it is checked, characters will be displayed in ASCII format. In this format, only ASCII characters will be displayed, including numbers, symbols and English letters. Chinese characters are not supported to display.

➤ Password

If it is checked, characters will be displayed in “*” mode.

➤ Unicode

If it is checked, characters will be displayed in UNICODE. In the UNICODE mode, each Chinese character or English letter will occupy one character (two bytes).

➤ Swap the High byte and the Low byte

After the “ASCII” is checked, you can select the function “Swap the High byte and the Low byte”.

● Read Address

➤ Reading And Writing Address Is Different

VEDA HCT User Manual

The character input component is integrated with functions of reading data from an address and writing data to an address. When the “Reading And Writing Address Is Different” is not checked, the using method is same to the “Character Display” component. When the “Reading And Writing Address Is Different” is checked, different address can be set in the “Read Address” and in the “Write Address”.

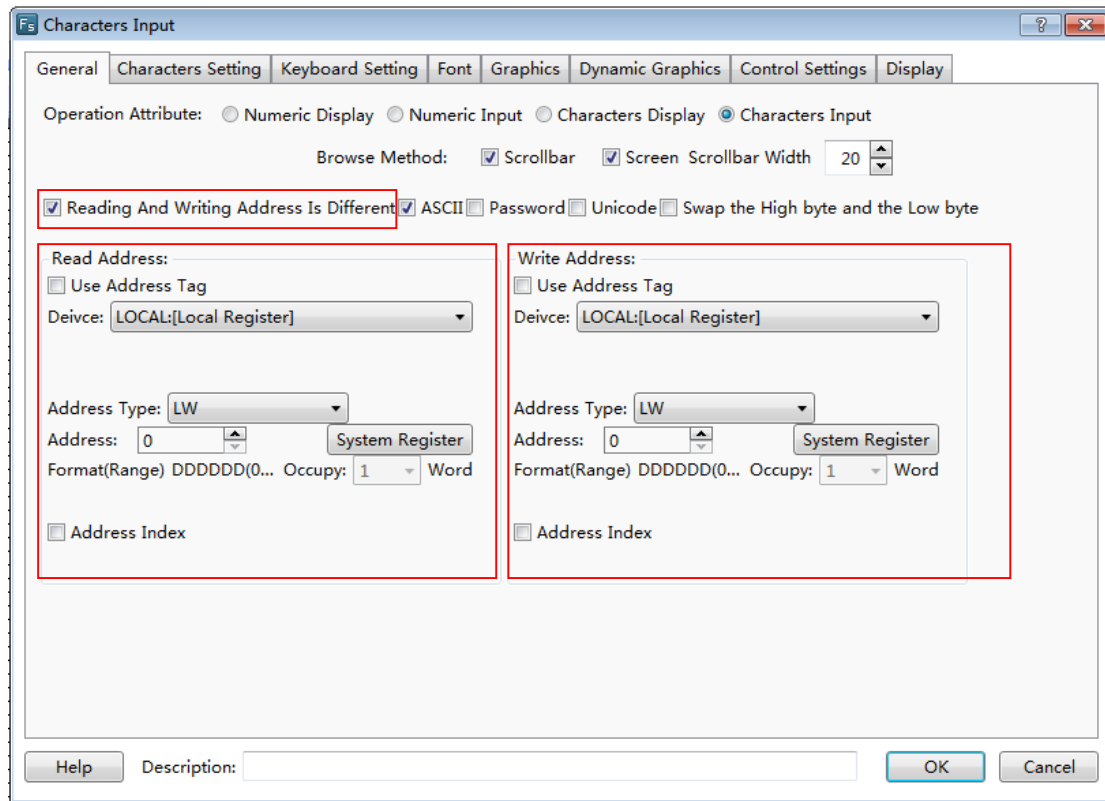

- Use Address Tag

VEDA HCT User Manual

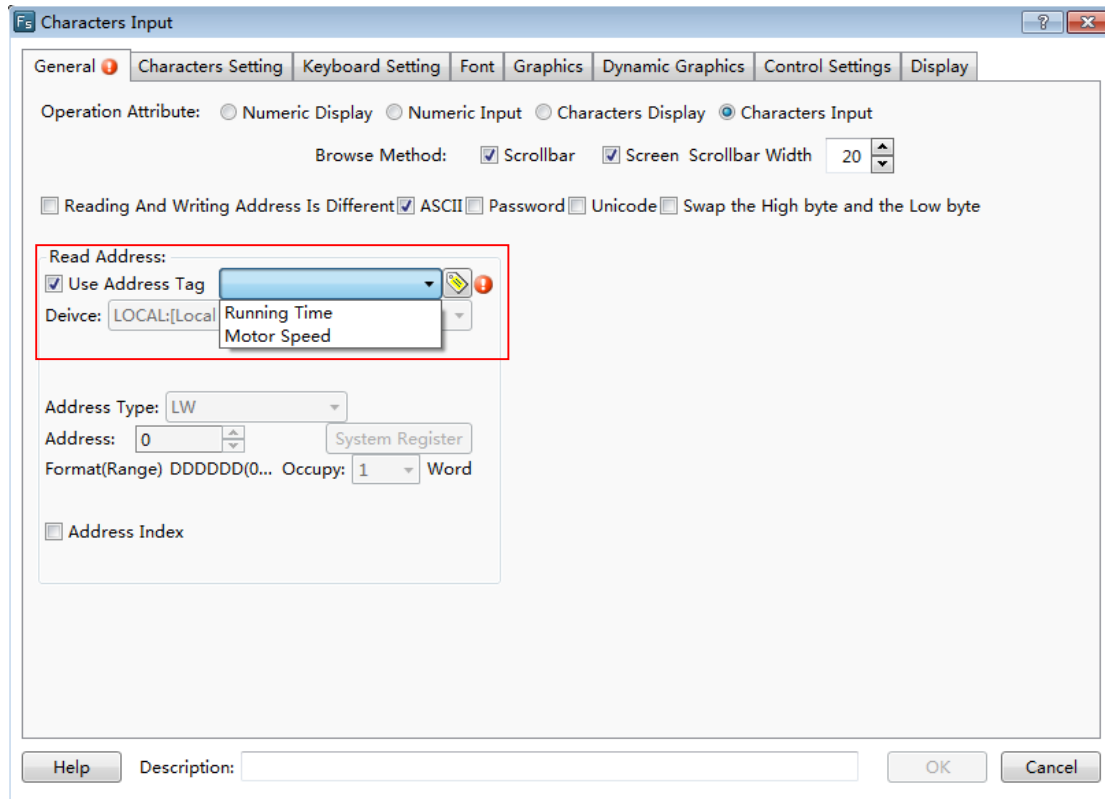

When this function is checked, variables in the address tag library can be directly linked by the component (See address tag library details in: [Detailed manual/Library/Address Tag Library](#)). The address tag library can be used to improve the project maintaining efficiency. If many components in the project are linked to a same variable in the address tag library and this address need to be modified, it is only necessary to modify the variable address linked in the tag library without modifying each component.

The character address setting includes the attributes : “Device”, “Address Type”, “Adress”, “Format (Range)”, “Address Index”, and so on. Please see: [Detailed manual/ General functions/ Address editor/Standard Byte Address Input](#).

4.6.3.4.2 Characters Setting

- Row Settings

VEDA HCT User Manual

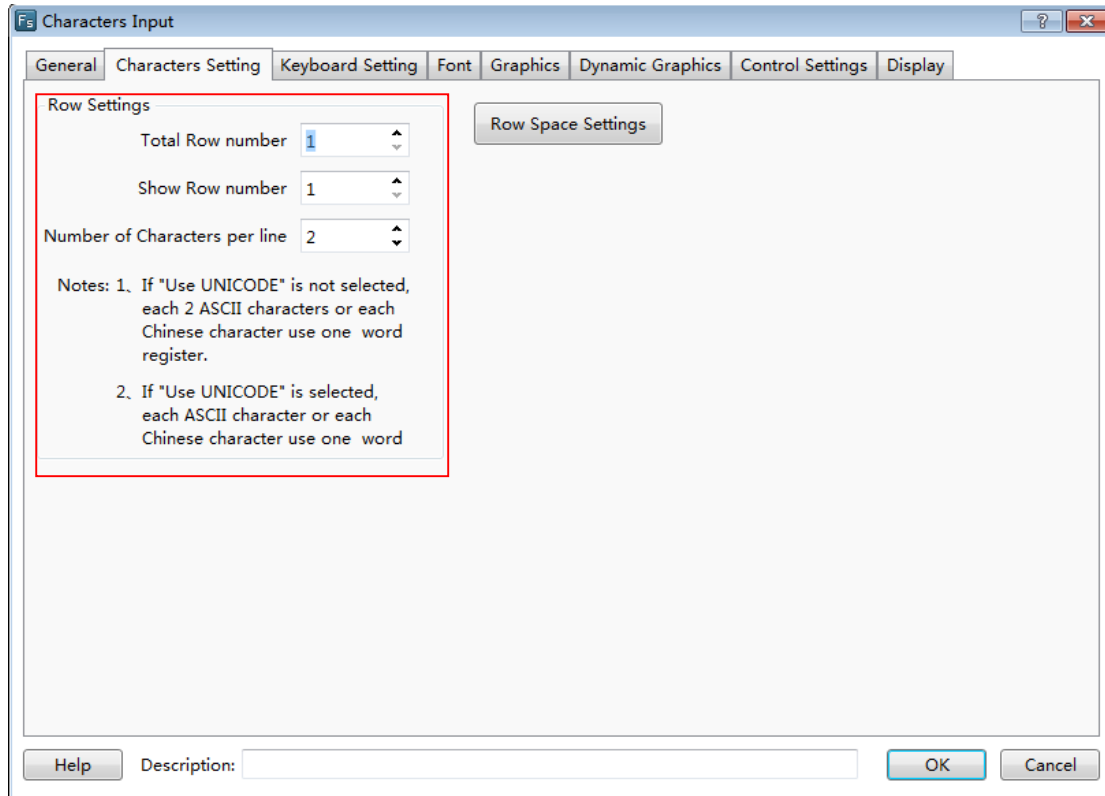

The “Row Settings” includes “Total Row number”, “Show Row number” and “Number of Characters per line”. The “Total Row number” means the number of the rows which the current character component contains. The “Show Row number” sets the number of rows displayed in the current character component. If the number of rows displayed is smaller than the number of total rows, a scrollbar will appear automatically.

Note:

If “Unicode” is not checked, each two ASCII characters or each one Chinese character occupies one word register.

If “Unicode” is checked, each ASCII character or each Chinese Character occupies one word register.

- Row Space settings

VEDA HCT User Manual

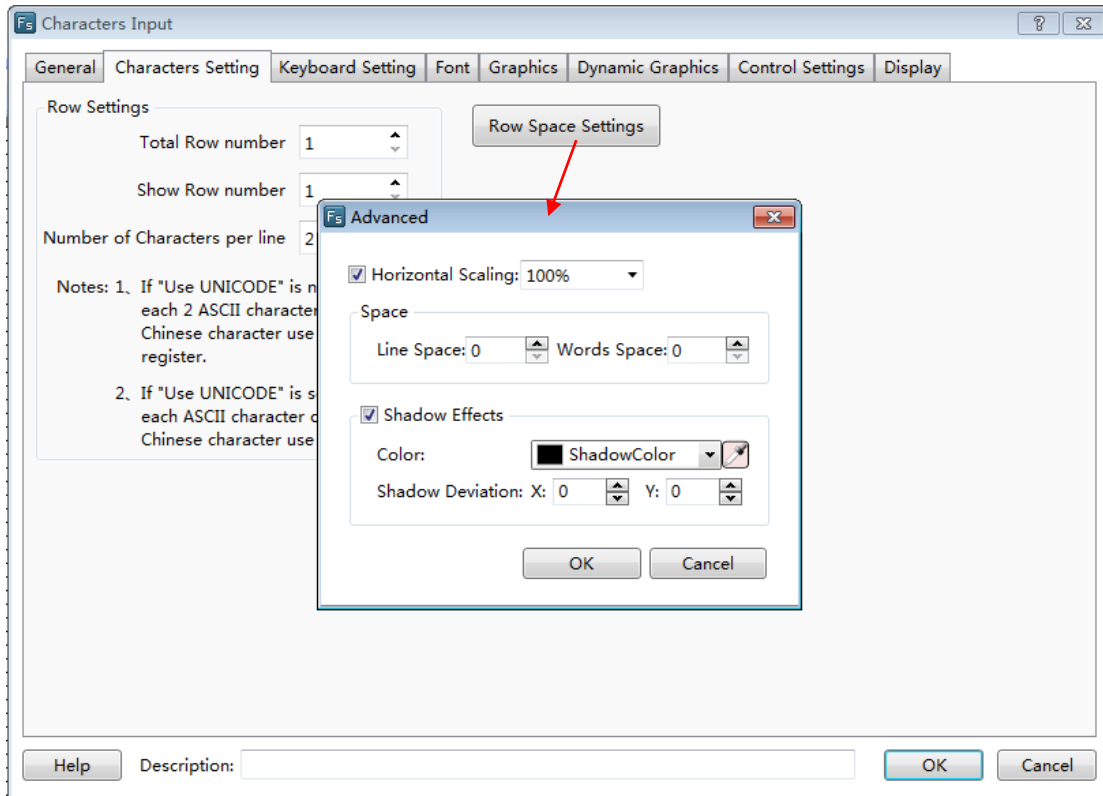

A dialog will pop up when you click the “Row Space Settings” button. You can set the attributes such as “Horizontal scaling”, “Line space”, “Words space”, shadow color and shadow deviation.

4.6.3.4.3 Keyboard Setting

See detailed setting in: [Detailed manual/ General functions/ Drawing/ Keyboard setting.](#)

4.6.3.4.4 Data font

See detailed font setting in: [Detailed manual/ General functions/ Drawing/Font settings.](#)

4.6.3.4.5 Control Settings

See detailed control setting in: [Detailed manual/ General functions/ Drawing/ Control settings.](#)

4.6.3.4.6 Display

See detailed display setting in: [Detailed manual/ General functions/ Drawing/ Display.](#)

4.6.4 Toggle Switch and menu

VEDA HCT User Manual

4.6.4.1 Bit Switch

The “Bit Switch” is used to set the action, switch type and text display of the bit switch which is used to change the bit state.

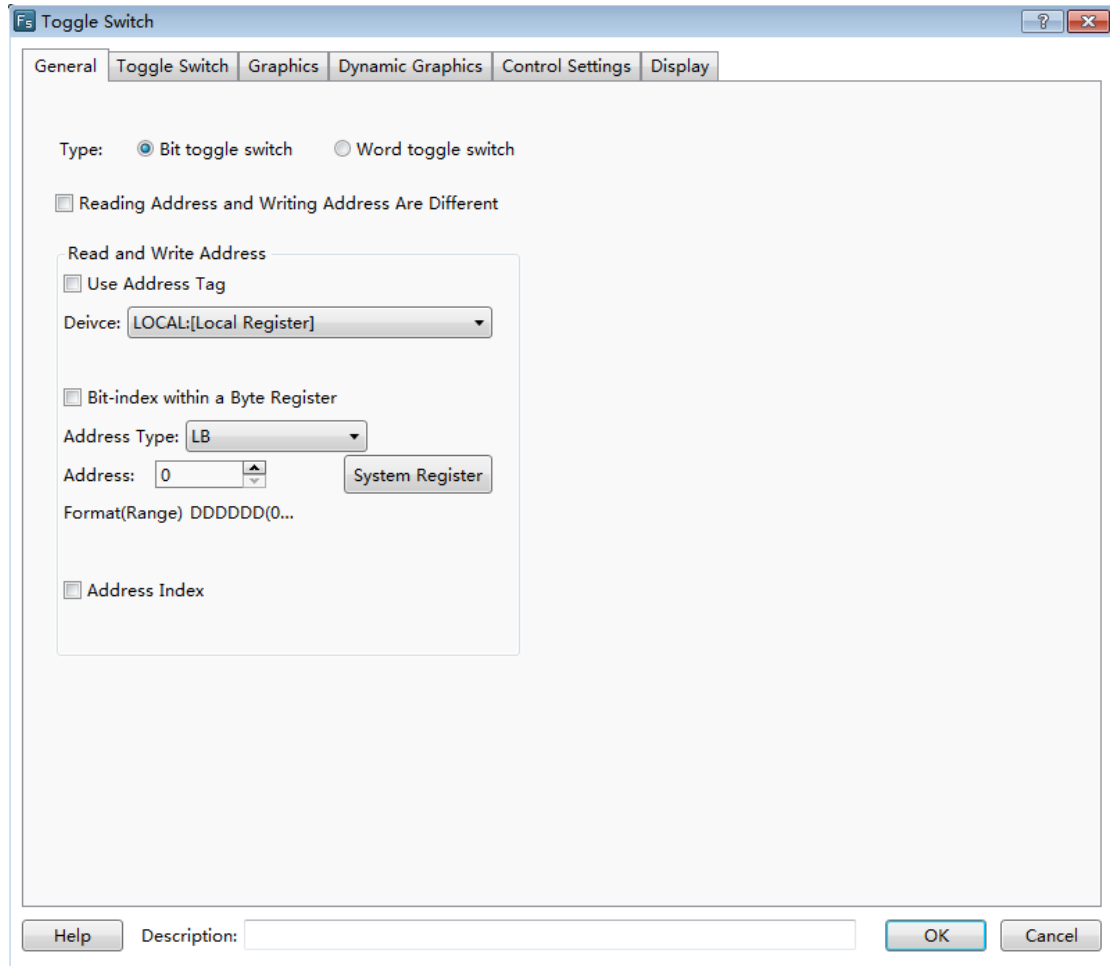

The “Bit Switch” component can be found on the tool bar or from the menu of Components.

VEDA HCT User Manual

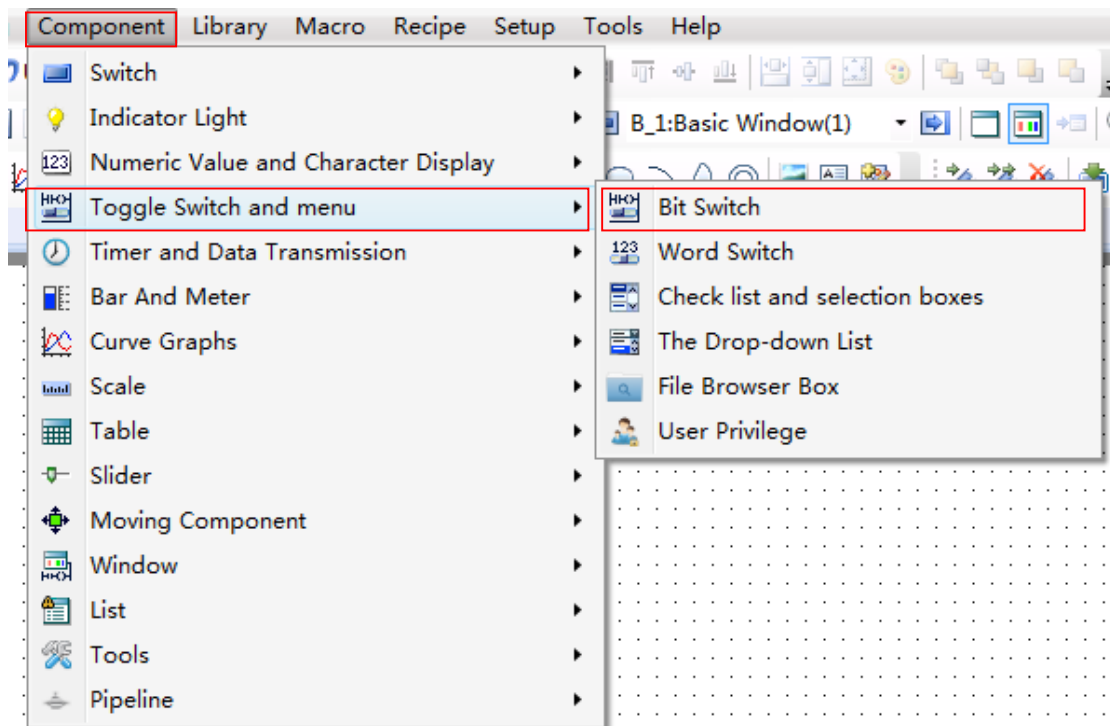
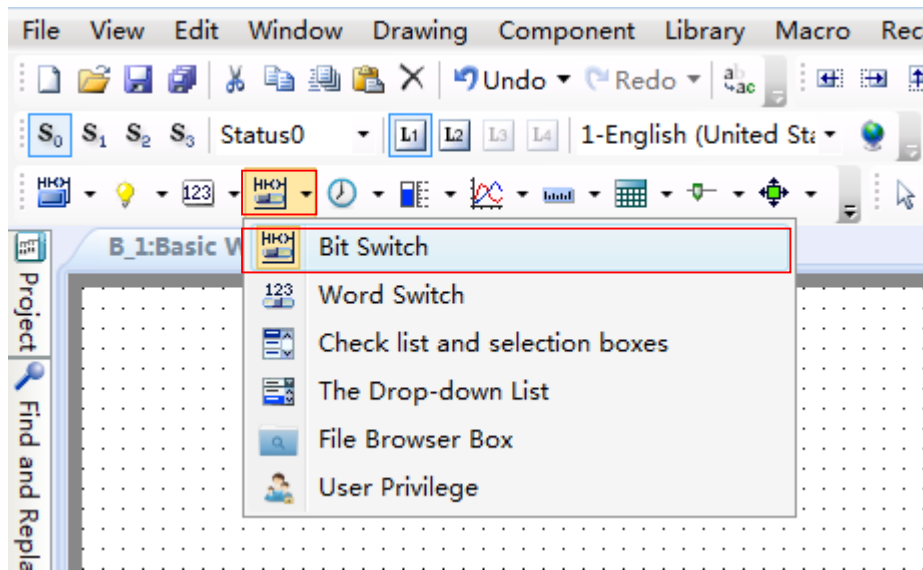

4.6.4.1.1 General

See details for bit address setting in: [Detailed manual/ General functions/ Address editor/ Standard Bit Address Input.](#)

4.6.4.1.2 Toggle Switch

On the page of "Toggle Switch", you can set "Press" or "Release" for the action. And the switch type can be "On", "Off", "Inverse" or "Reset".

VEDA HCT User Manual

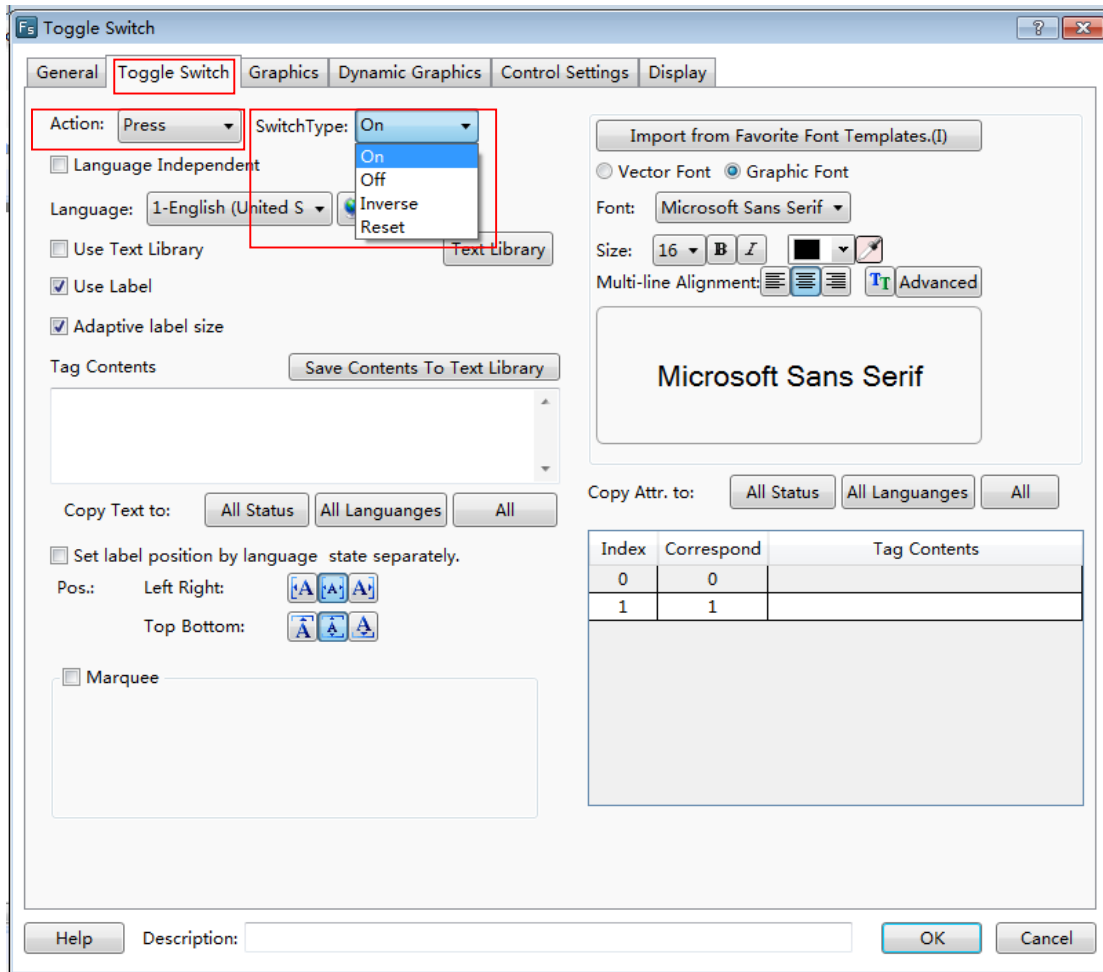

Details for “Language” selection can be seen in: [Detailed manual/Setup/System Settings/Language Settings.](#)

Details for “Import Favorite Font Template” can be seen in: [Detailed manual/Setup/System Settings/Favorite Font Template.](#)

Details for “Text Library” can be seen in: [Detailed manual/Library/Text Library.](#)

Details for “Marquee” setting can be seen in: [Detailed manual/ General functions/ Drawing/ Marquee.](#)

4.6.4.1.3 Graphics

Details for Graphics can be seen in: [Detailed manual/ General functions/ Drawing/ Graphic edit.](#)

4.6.4.1.4 Control Settings

VEDA HCT User Manual

Details for control settings can be seen in: [Detailed manual/ General functions/ Drawing /Control settings.](#)

4.6.4.1.5 Display

Details for display setting can be seen in: [Detailed manual/ General functions/ Drawing /Display.](#)

4.6.4.2 Word Switch

The word switch is used to set the action and text display for word address states.

The “Word Switch” component can be found on the tool bar or from the menu of Components.

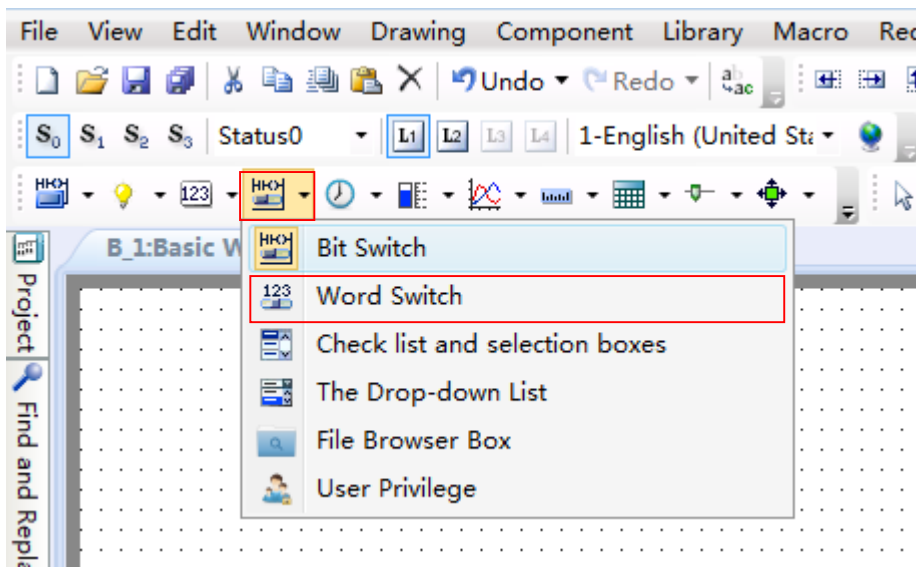

VEDA HCT User Manual

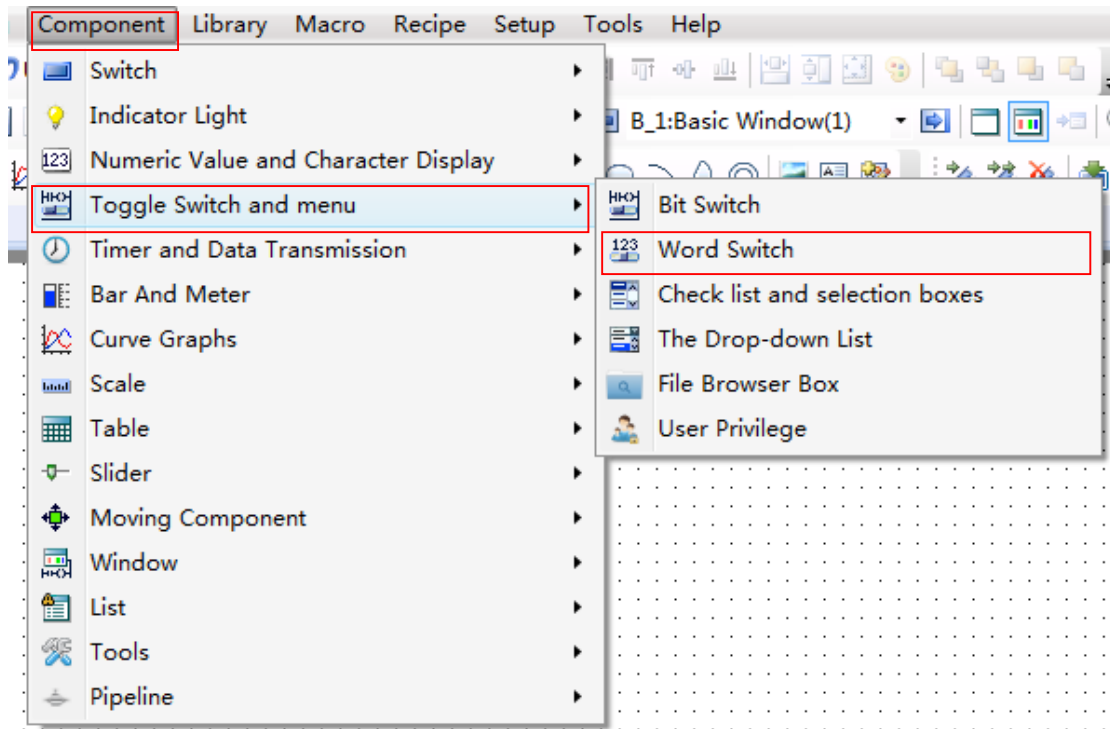

4.6.4.2.1 General

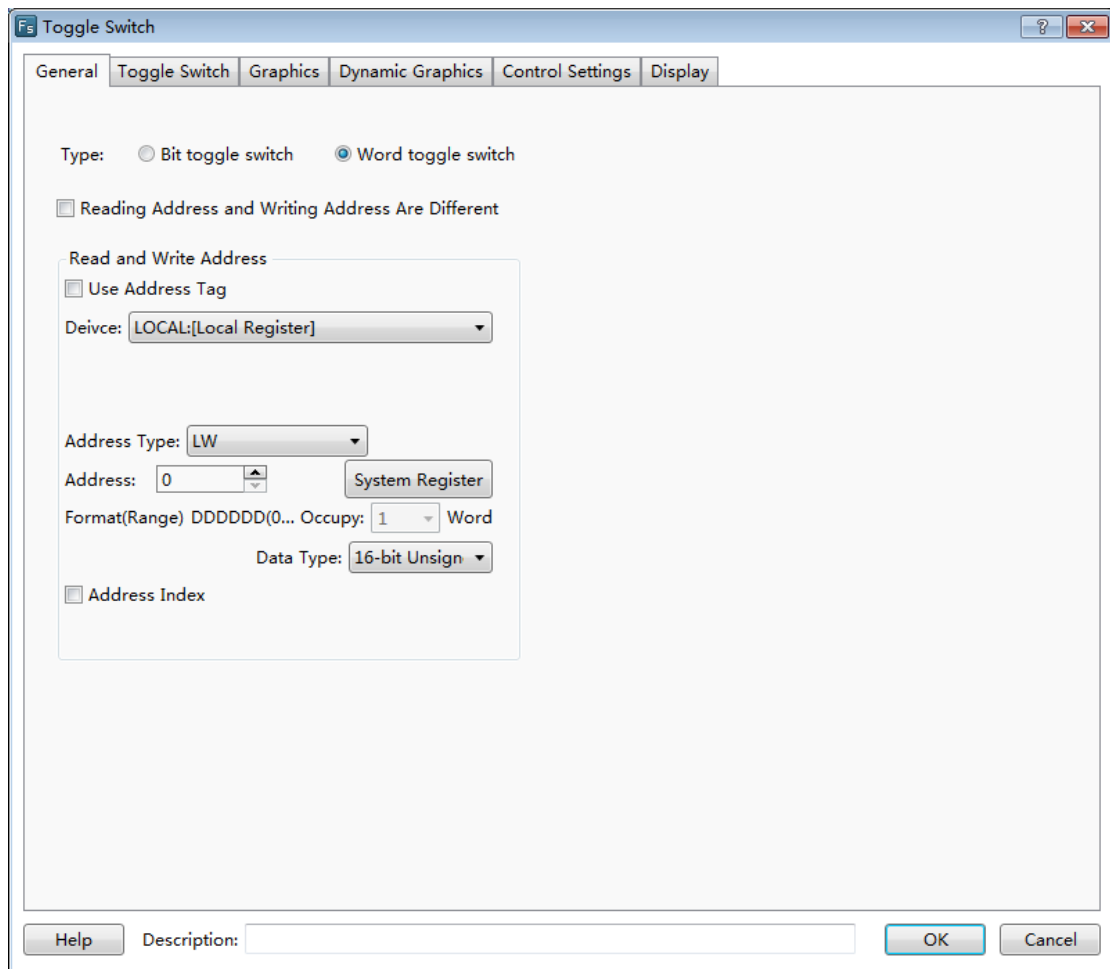

VEDA HCT User Manual

See details for word address setting in: [Detailed manual/General functions/Address editor/Standard Byte Address Input.](#)

4.6.4.2.2 Toggle Switch

On the page of “Toggle Switch”, the action can be set “Press” or “Release”. The switch type can be set to “Add” or “Subtract”. If “Non-cyclic” is checked and the switch type is “And”, it will stop adding when the result exceeds the maximum value. If “Non-cyclic” is not checked for the “Add” switch type, it will start to shift again from the minimum value when the result reaches the maximum value. The “Status” can be set directly or by the Up or Down arrows.

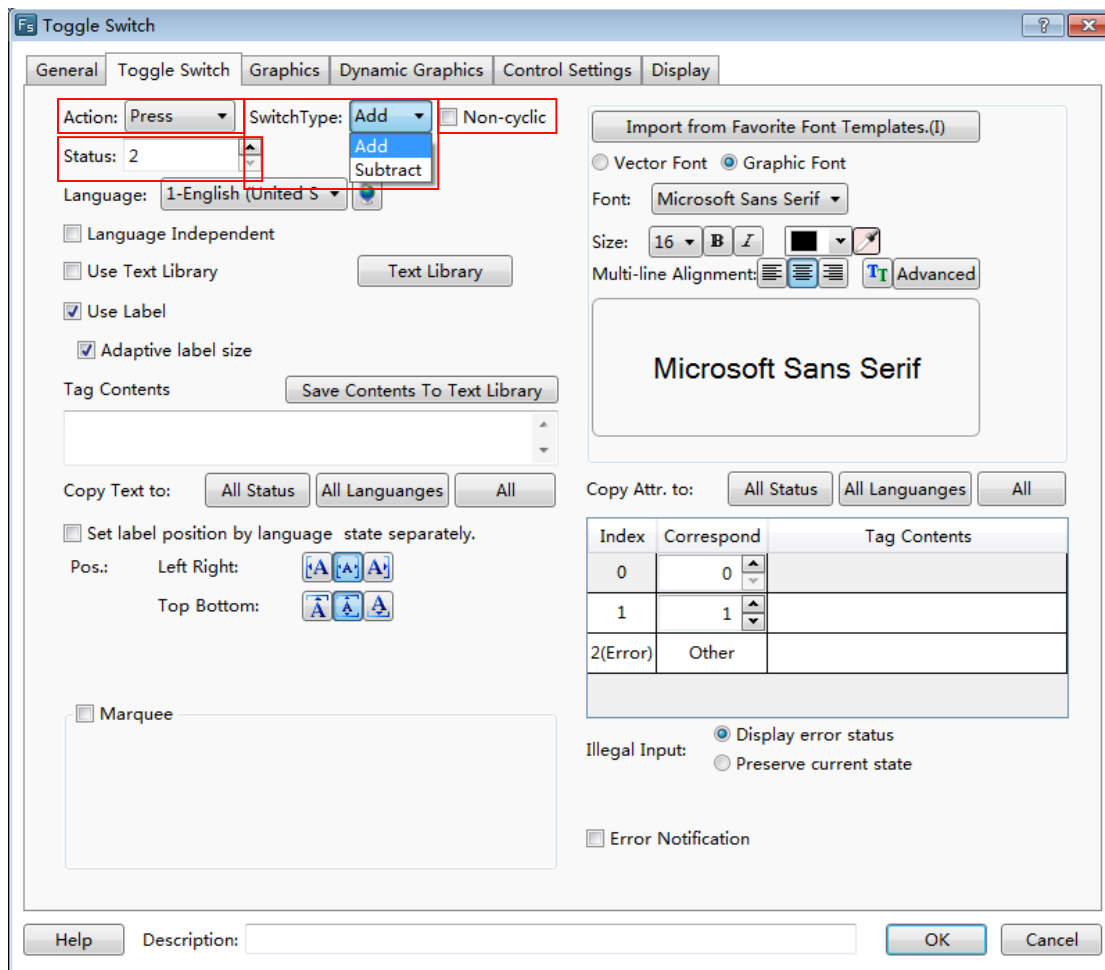

Details for “Language” selection can be seen in: [Detailed manual/Setup/System Settings/ Language Settings.](#)

Details for “Import Favorite Font Template” can be seen in: [Detailed manual/Setup/System Settings/Favorite Font Template.](#)

Details for “Text Library” can be seen in: [Detailed manual/Library/Text Library.](#)

VEDA HCT User Manual

Details for “Marquee” setting can be seen in: [Detailed manual/ General functions/ Drawing/ Marquee](#).

4.6.4.2.3 Graphics

Details for Graphics can be seen in: [Detailed manual/General functions/Drawing/Graphic edit](#).

4.6.4.2.4 Control Settings

Details for control settings can be seen in: [Detailed manual/ General functions/ Drawing /Control settings](#).

4.6.4.2.5 Display

Details for display setting can be seen in: [Detailed manual/ General functions/ Drawing /Display](#).

4.6.4.3 Check list and selection boxes

The component of “Check list and selection boxes” is used to operate “Word register”. The preset value is written into the register and the preset text is displayed when the current component is operated. The preset text corresponding to the status value which is equal to the word register will display automatically. See the following description for details.

Click the menu command of the “Check list and selection boxes” component and open the property TAB of this component.

4.6.4.3.1 General

VEDA HCT User Manual

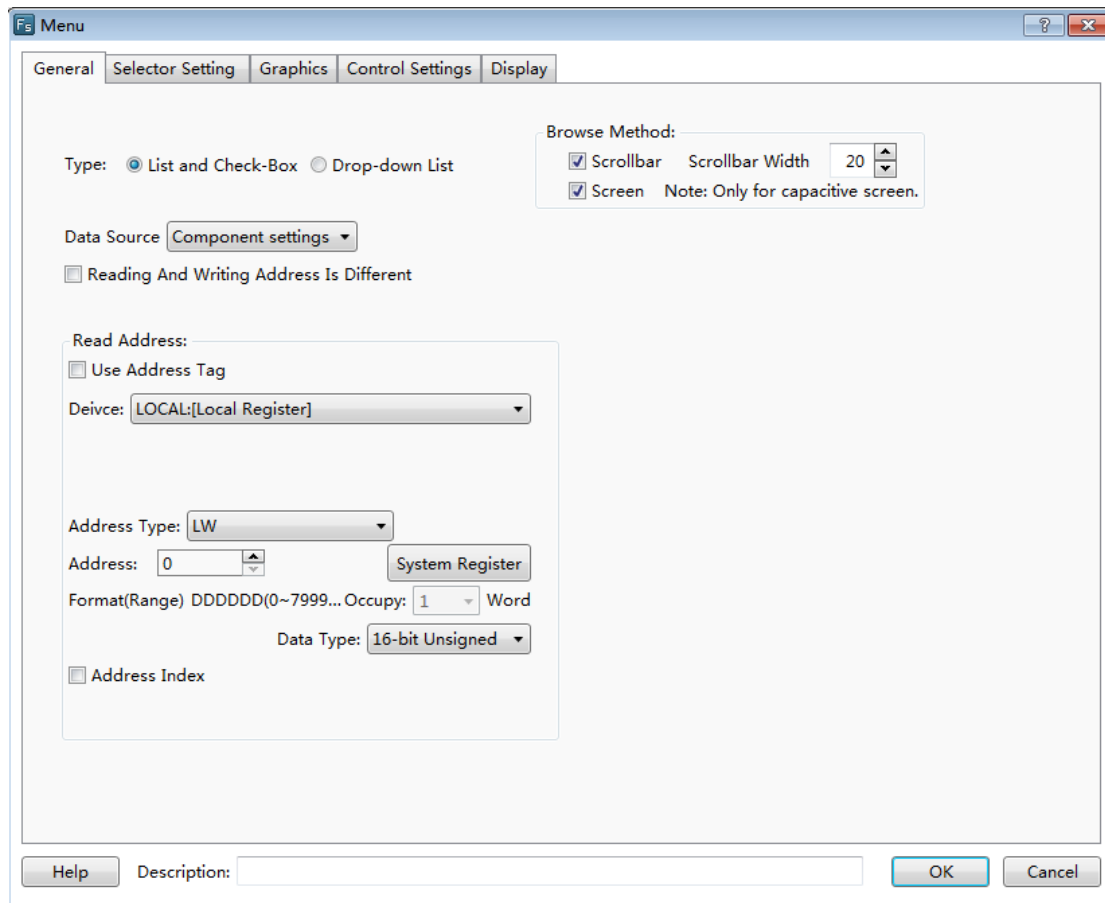

- Browse Method

The “Browse Method” includes “Scrollbar” and “Screen”. You can select the “Scrollbar” or the “Screen” or both ways to browse the content of the current component. The scrollbar width can be freely set and the default width is 20. The “Screen” browse method is only effective for a capacitive screen.

- Data Source

The default is “Component settings”. That means the data source is the word register.

- Reading And Writing Address Is Different

The default is not checked. That means the read address and the write address are same. When it is checked, the “Read” register and the “Write” register can be set separately. The value of the “Read” register will be compared with the preset value to determine the corresponding text display. The preset value corresponding to the status selected will be written into the “Write” register when the component is operated.

4.6.4.3.2 Selector Setting

VEDA HCT User Manual

On the page of “Selector Setting”, the attributes such as the number of items (“Item Count”), the preset value of each item and the content to be displayed can be set.

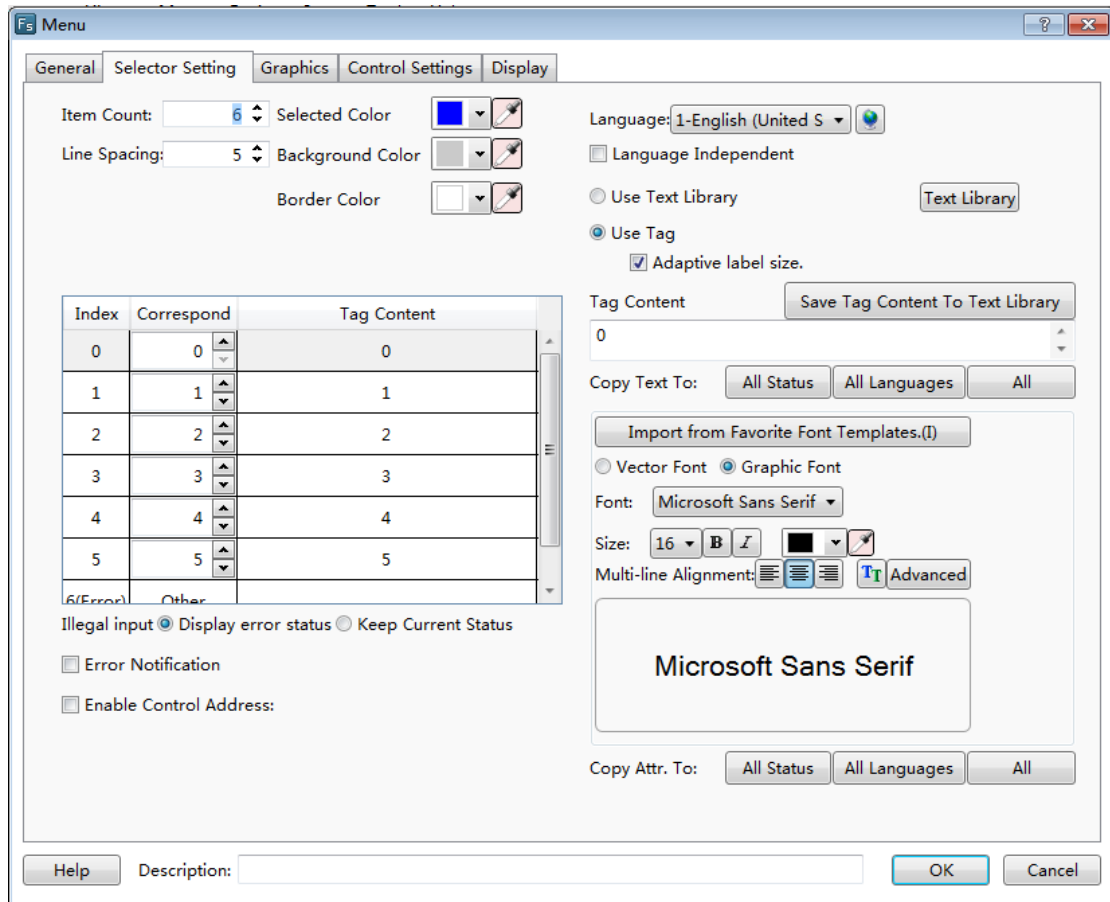

- Item Count

The default is 6. The range is 1~255. That means there are 255 items at most.

- Line Spacing

The default is 5. That means the space between rows.

- Selected Color

You can modify the color of the item selected in operation. The default is blue.

- Background Color

It is the background color of the component excluding the scrollbar. The default is grey.

- Border Color

VEDA HCT User Manual

It is the frame color of the selecting list components excluding the rolling bar, and the default is white.

- “Index”, “Correspond” and “Tag Content”

There is a table for the list components. It includes three columns: “Index”, “Correspond” and “Tag Content”.

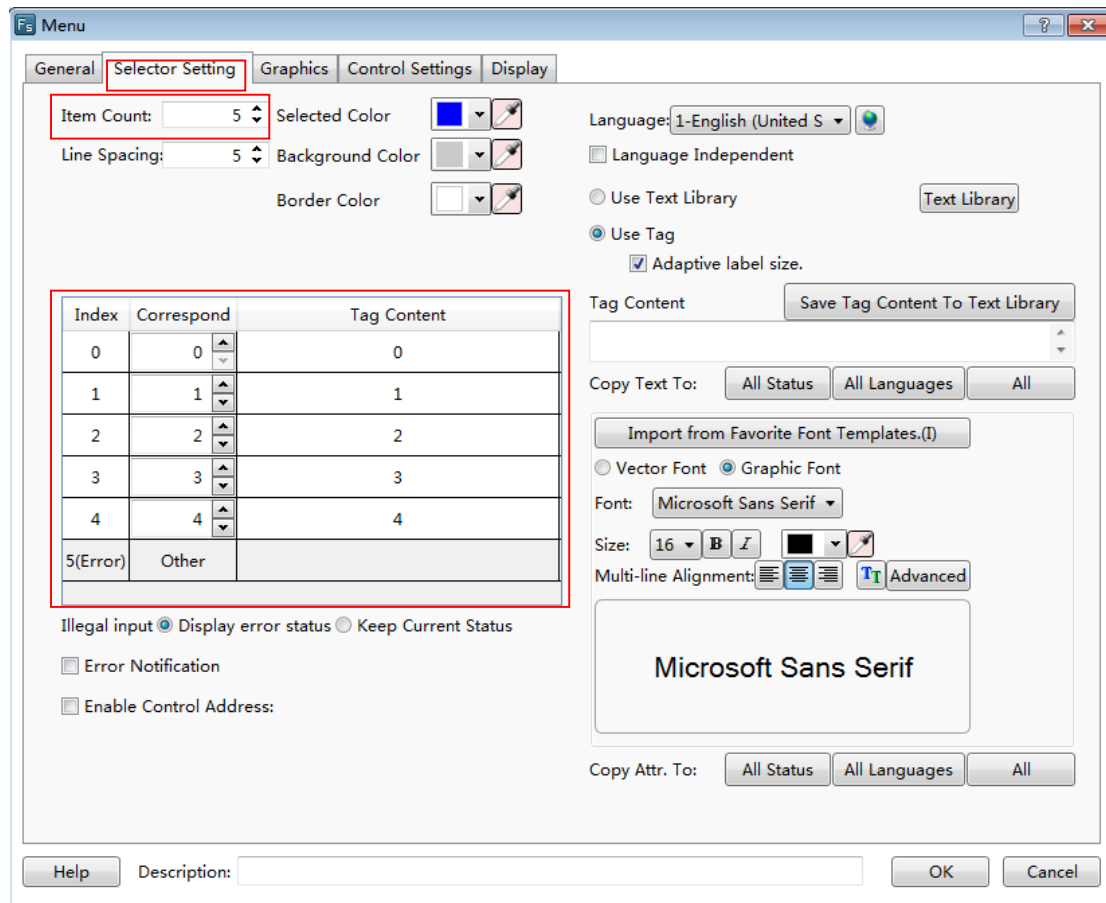

For example, the “Item Count” is set 5. The value of the “Index” is 0~5. Index 0~4 are corresponding to effective items and item 5 is corresponding to the “Error” one.

The default value of the column “correspond” is equal to the value of the “Index” for the effective items. When the number of items is set to 5, the content of the “correspond” for the index 5 is “Other”. The “Other” means any value except “0~4”. The “correspond” value can be modified. For example, the “correspond” value of index 0 is modified 100. That means the text of index 0 in the “Tag Content” will be displayed if the value of the word register is equal to 100. And meanwhile, if item 0 is selected, the value 100 will be written into the word register.

The default value of the column “Tag Content” is equal to the value of the “Index” for the effective items. When any item is selected, the text required can be input to the corresponding “Tag Content”.

VEDA HCT User Manual

- Illegal input

The “Illegal input” means that the value of word address doesn't equal to any value of the “correspond” for the effective items. The default is “Show Error Status”.

- Show Error Status

The component displays the “correspond” content of the “Error” item when illegal input happened.

- Keep Current status

The component keeps the last correct status when illegal input happened.

- Error Notification

When it is checked, a “Bit register” can be set. The “Bit register” will be set to ON if any error status appears.

- Enable Control Address

If it is checked, a “Word register” can be set. Each bit of the word register is corresponding to an index. That is, bit 0 is corresponding to index 0, and bit 1 is corresponding to index 1, and so on. When there are more than 16 items, the next word register will be occupied automatically. When the corresponded bit of the word register is ON, the item of the corresponding index in the list will be hidden. For example, when the word register value of the “Enable Control Address” is set to 5, the bit 0 and bit 2 of this word register are both ON and the items of the index 0 and the index 2 will be hidden.

VEDA HCT User Manual

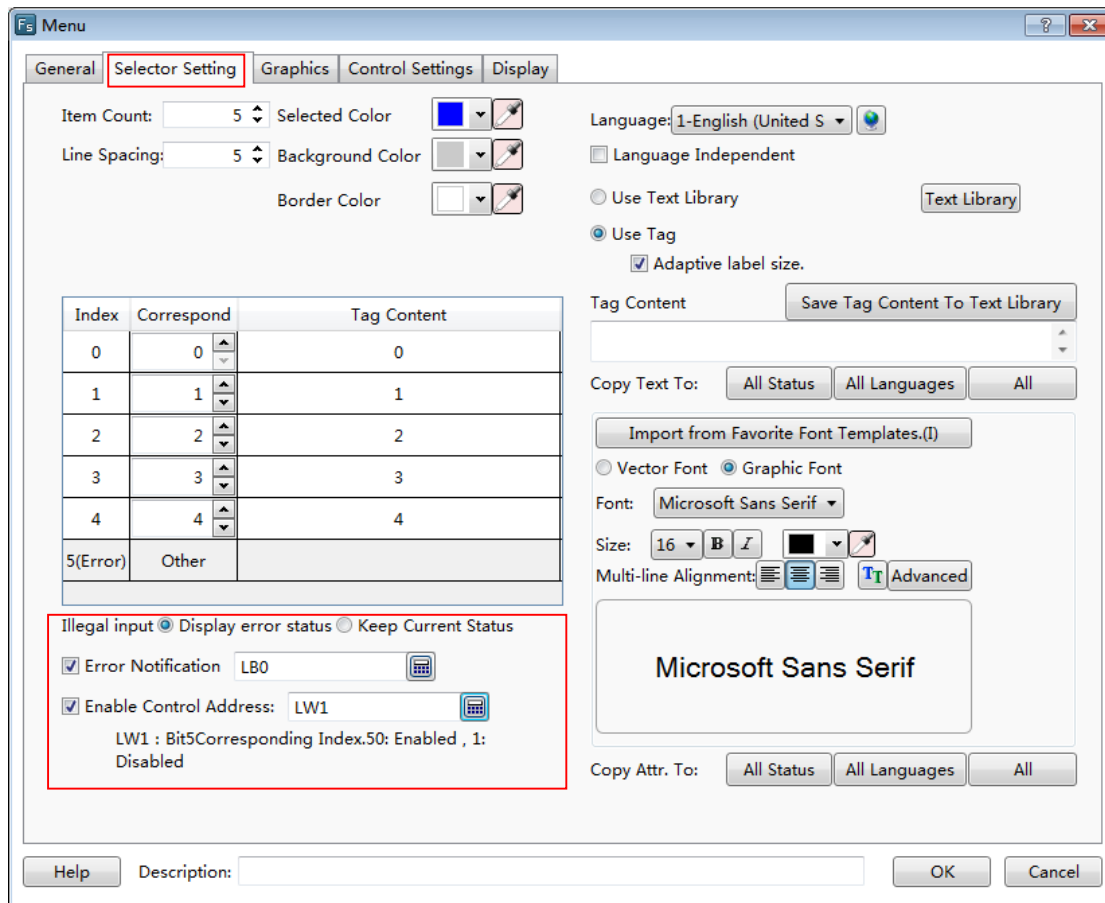

In the figure above, when there is any wrong status, LB0 will be set to ON. When LW1=5, index 0 and index 2 will be hidden.

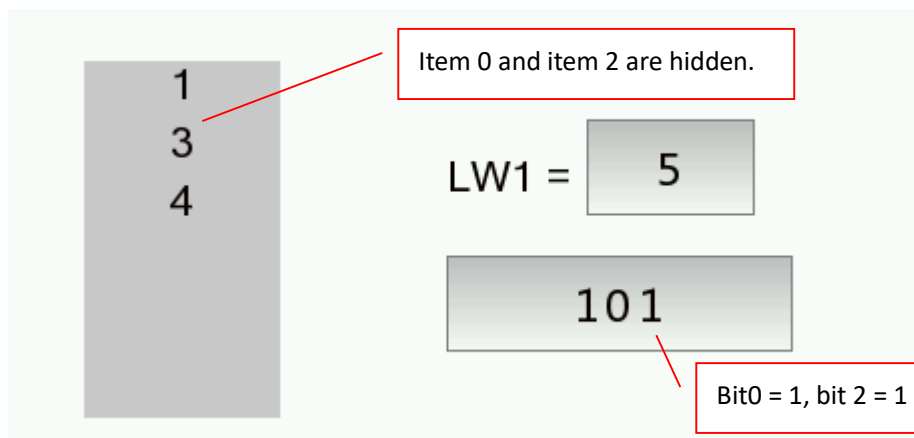

4.6.4.4 The Drop-down List

The attributes of "The Drop-down list" are almost same to the attributes of "Check list and selection box". The main difference is that "The Drop-down list" is withdrawn when it is not operated or after it is operated. The "Drop-down list" will be unfolded when it is clicked, and then it can be viewed and operated by the scrollbar or by screen method.

VEDA HCT User Manual

4.6.4.4.1 General

The property TAB of “The Drop-down list” can be opened by clicking the command “Component/ Toggle Switch and menu/ The Drop-down List” in the menu, see the figure below.

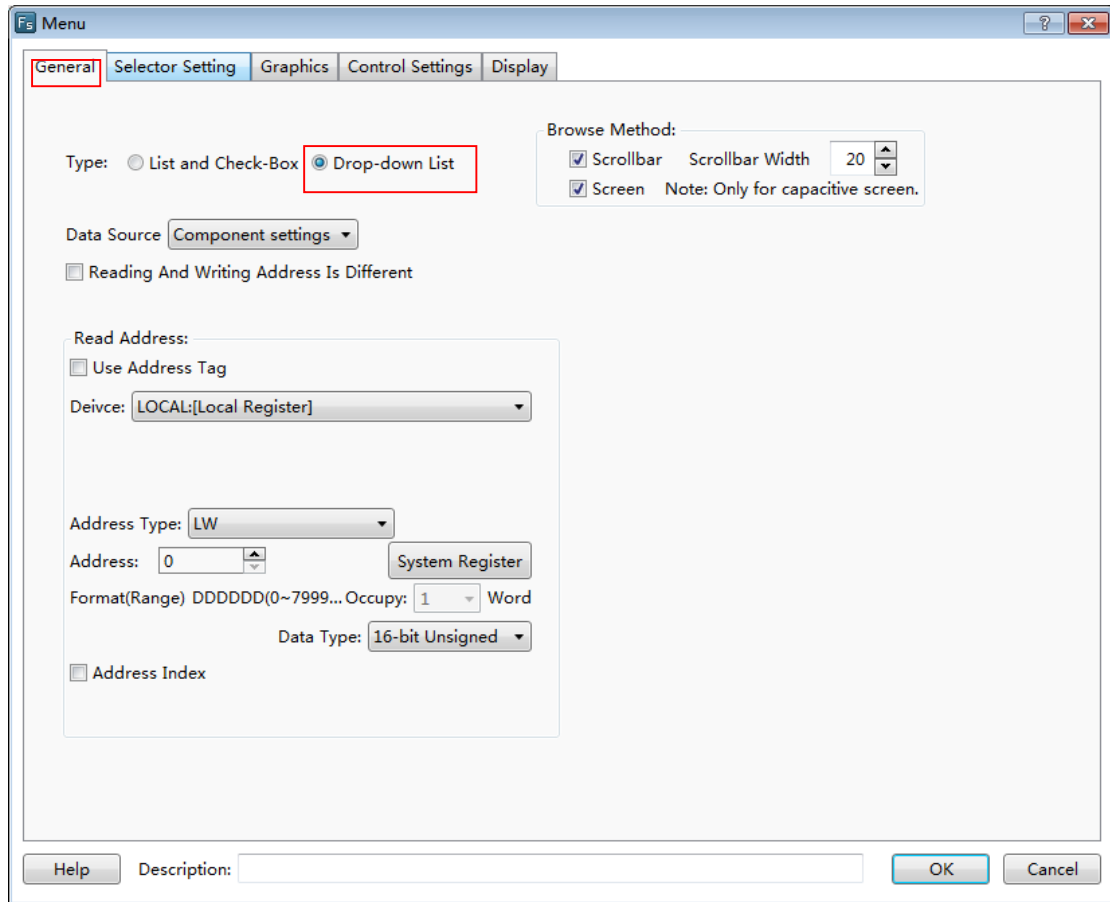

The figure above shows that the “General” property TAB is same to the “Check list and selection boxes”, it is not introduced here, and details can be seen in [Detailed manual/Component/Toggle Switch and menu/Check list and selection boxes](#).

4.6.4.4.2 Selector Setting

Click the “Selector Setting” property TAB, it can be opened, see the figure below.

VEDA HCT User Manual

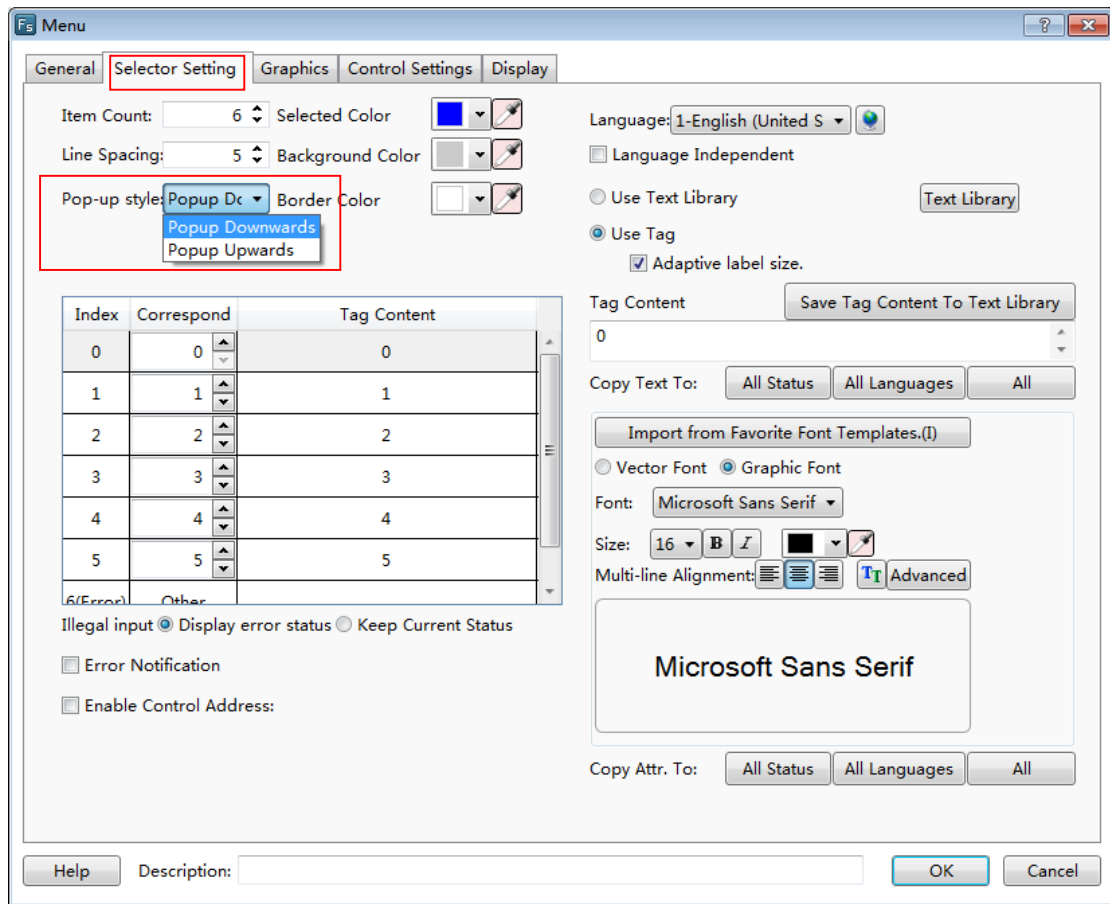

For “The Drop-down List” component, the most settings of the “Selector Setting” property TAB are same to the “Check list and selection boxes”. The difference is that there is an additional item of “Pop-up style” for the “The Drop-down List”.

The default is “Pop-up Downwards”. The “Pop-up upwards” is optional. And it can be set according to the actual requirement. See the figure below.

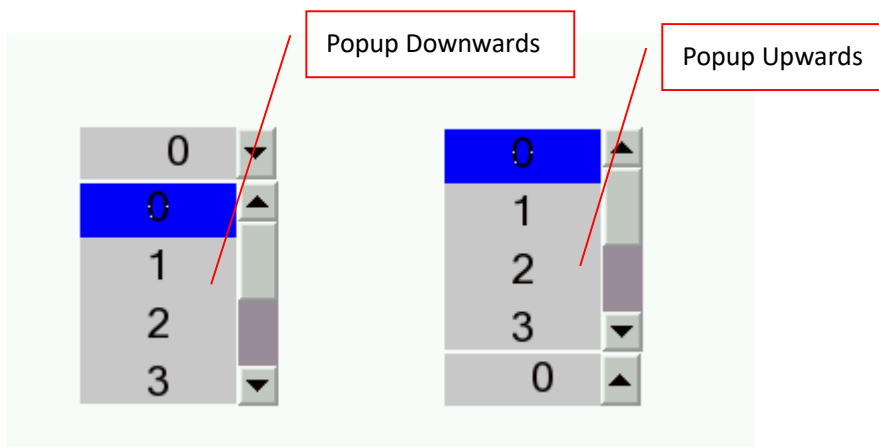

The figure below shows the situation when “The Drop-down List” and “Check list and selection boxes” appear on the picture at the same time.

VEDA HCT User Manual

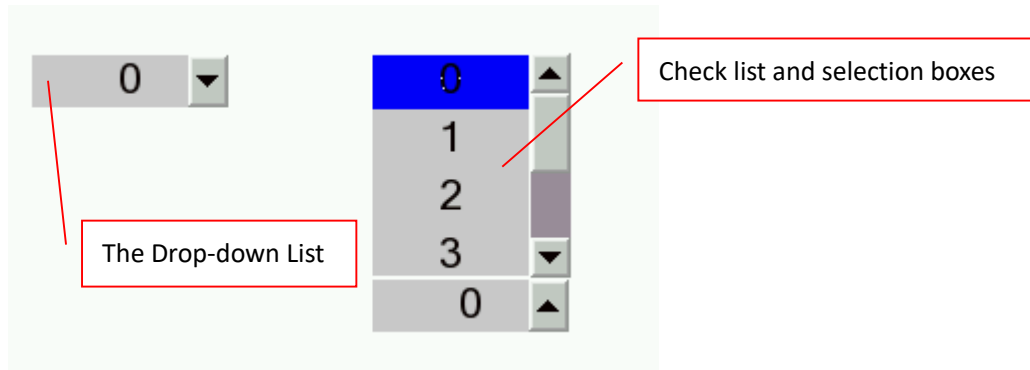

The figure above shows that when the “The Drop-down List” completes operation or has no operation, it is “withdrawn”. It will be unfolded only when it is operated, while the “Check list and selection boxes” is always unfolded no matter it is in operation or not, and it can be directly viewed and operated.

The other details can be seen in [Detailed manual/Component/Toggle Switch and menu/Check list and selection boxes.](#)

4.6.4.5 File Browser Box

File Browser Box is used to display the file information of the internal and external storage devices.

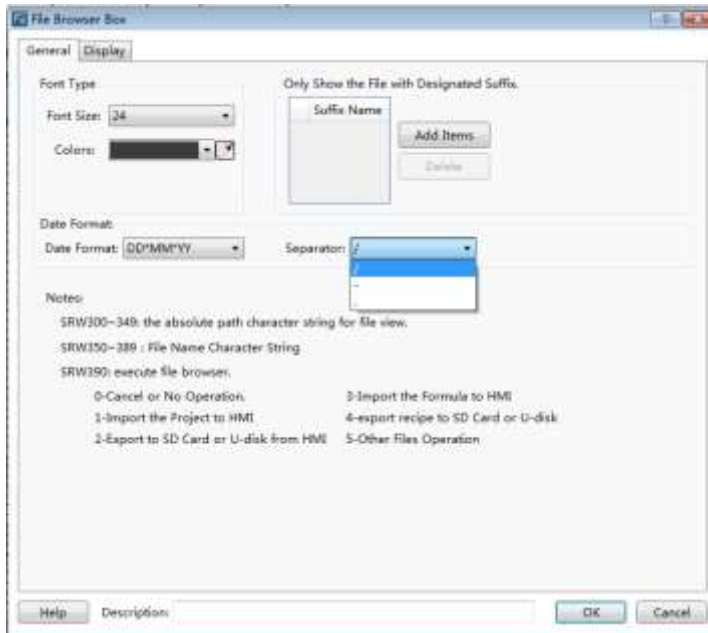

4.6.4.5.1 General

- Font Type
- Font Size

VEDA HCT User Manual

Select the appropriate font size here.

➤ Colors



Select the font color by the tool “” or the color palette. When it is selected on the touch screen, the background color of the font is in the inverse tone.

● Date Format

There are three optional date formats.

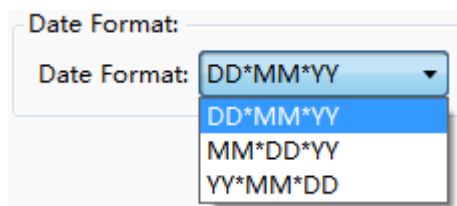

There are three optional separators provided among the day, the month and the year.

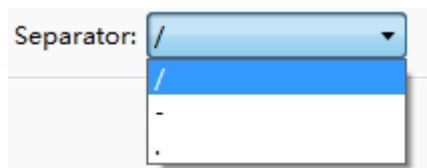

● Only Show the File with Designated Suffix.

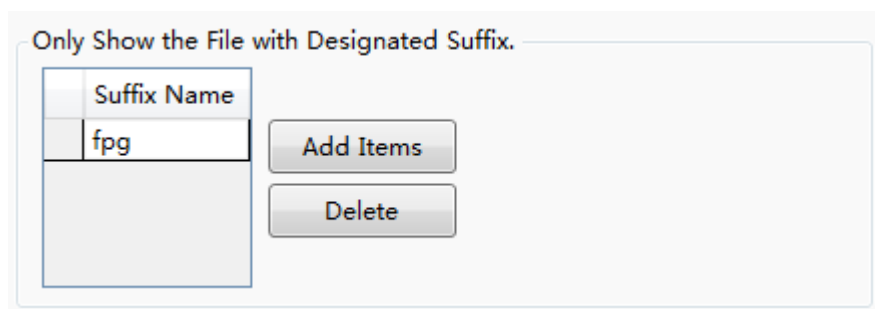

The suffix is blank by default. It represents to display all. You can set the file type you want.

As shown as above, if you add the “fpg” suffix by clicking the button “Add Items”, only files with fpg suffix will be displayed in the browser box for easy filtering and viewing. If you want to display all, click the button “Delete” and keep the browser box blank.

VEDA HCT User Manual

4.6.4.5.2 Display

The settings of the “Display” property TAB are referred to: [Detailed manual/General functions/Drawing/Display.](#)

4.6.4.6 User Privilege

4.6.4.6.1 General

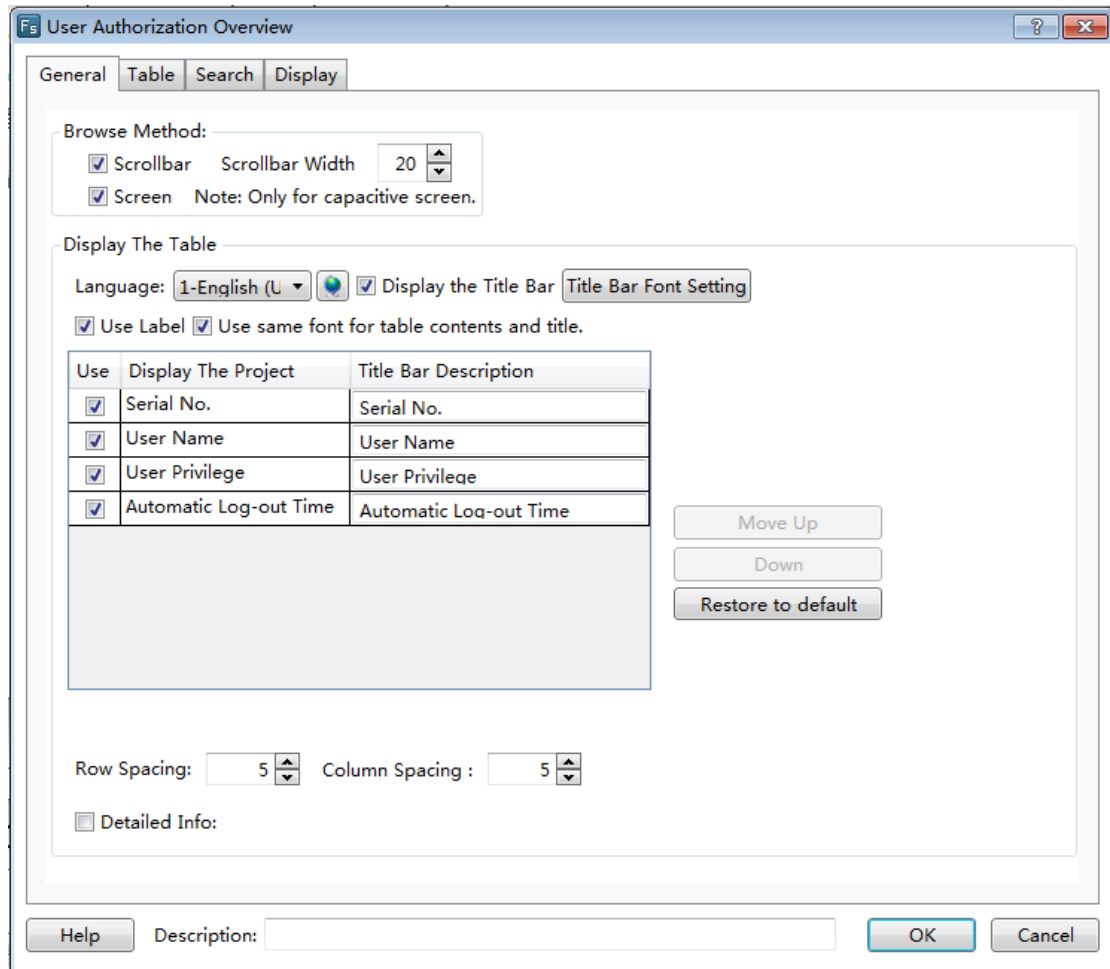

- Browse Method

You can view by scroll bar or screen sliding, and screen sliding is only effective for capacitive screen.

- Display The Table

- Language

You can switch between Chinese and English here, and then you can edit the text in the below table in Chinese and in English separately.

VEDA HCT User Manual

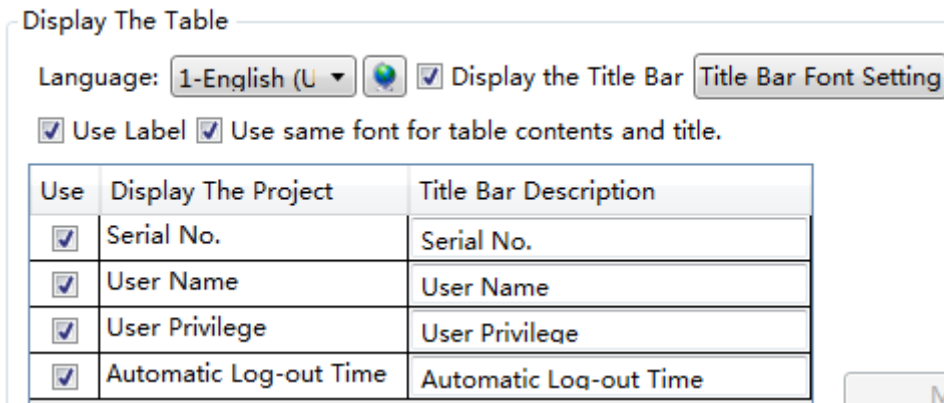

➤ Display the Title Bar

Check this option “Display the Title Bar”, you can set the font of the title bar and the list, see details in [Detailed manual/General functions/Drawing/Font settings.](#)

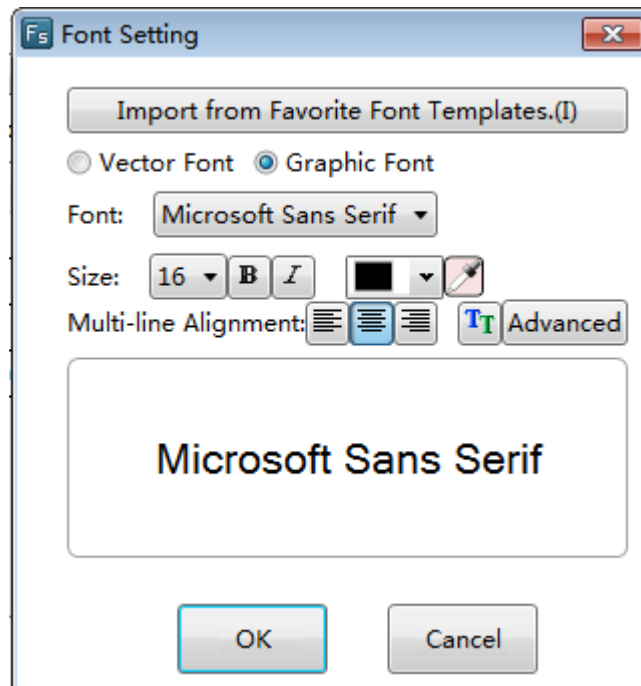

➤ Use Label

Check this option, you can edit the “Title Bar Description” in the below table. Uncheck it, you can edit the “Title Bar Description” by using text library.

VEDA HCT User Manual

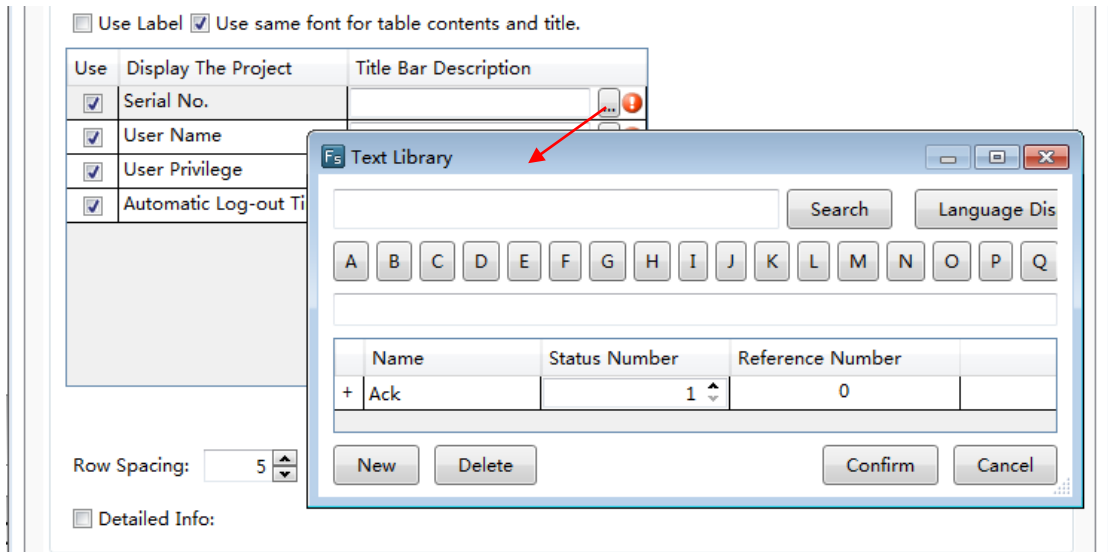

- Use same font for table contents and title

This option will be displayed only when you check the option “Display the Title Bar”. After checking this option, the font of the list will be consistent with the font of the title bar. If you do not check it, you can edit the font of the list separately.

- Move UP and Down

You can adjust the arrangement of the displayed items by clicking the button “Move Up” or “Down”.

- Restore to default

Restore the items to the initial arrangement.

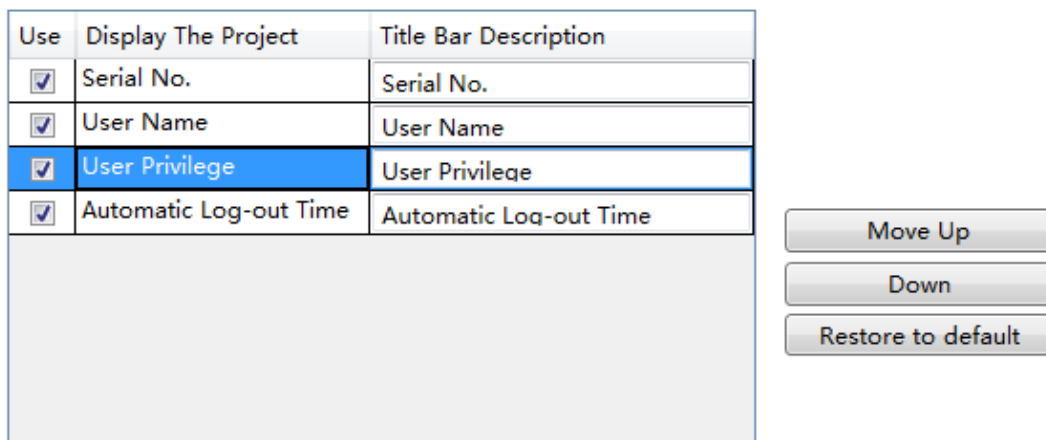

- Row Spacing and Column Spacing

VEDA HCT User Manual

Adjust the row spacing by modifying the value of the edit box of “Row Spacing”. And adjust the column spacing by modifying the value of the edit box of “Column Spacing”.

➤ Detailed Info

Detailed Info: Single Click Popup Window: B_29001:User privilege

After check the option “Detailed Info”, you can select a trigger mode to pop up the window such as “User privilege” for editing. The trigger mode can be set “Single Click” or “Double Click”.

4.6.4.6.2 Table

You can set the appearance of the “User Privilege” component in the “Table” property TAB. The appearance of this component is show as below.

Title Bar Background Color

Serial No.	User Name	User Privilege	Automatic Log-out Time
0	Admin	16	10

Table Background Color Row Split Line Column Split Line Outline

The “Table” property TAB of the “User Privilege” component is shown as below.

VEDA HCT User Manual

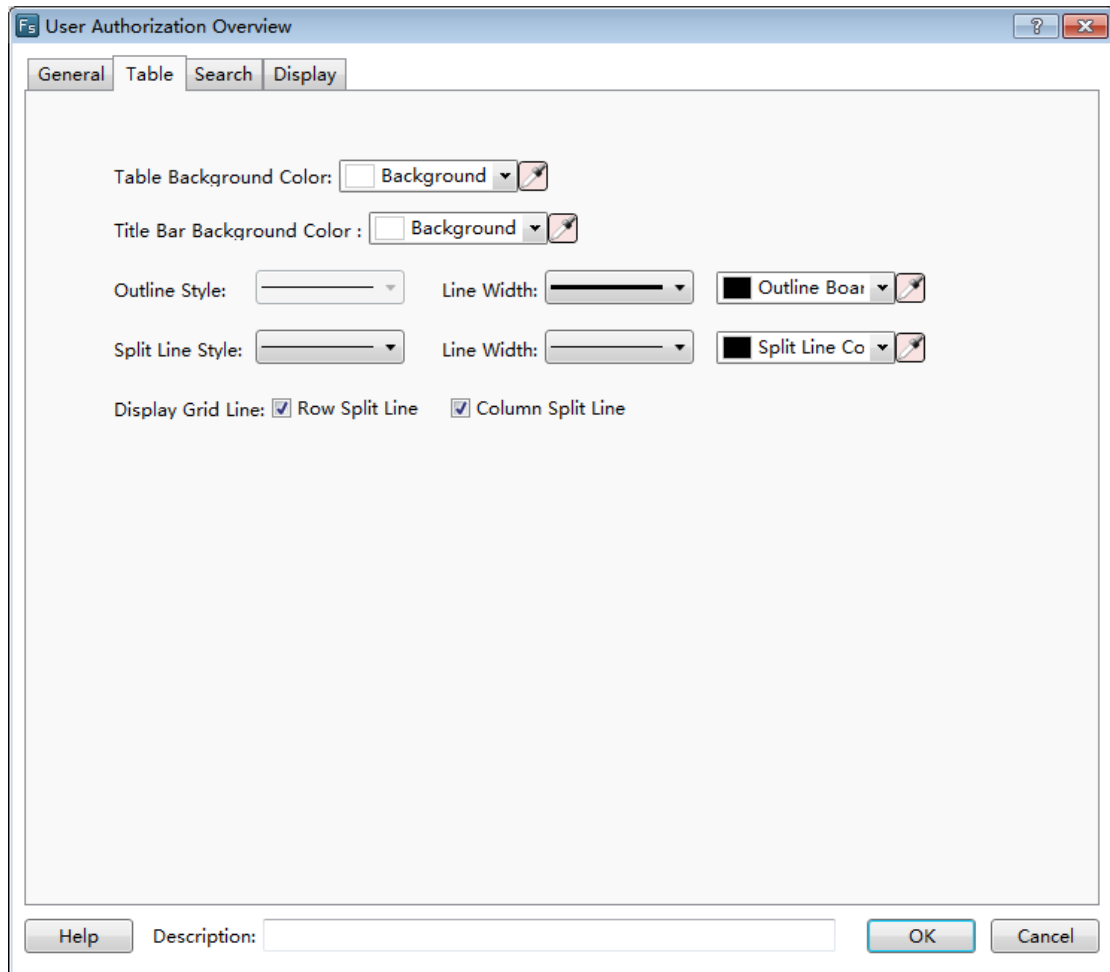

- Table Background Color and Title Bar Background Color

You can change the background color of the “User Privilege” component. And you can change the title bar background color, too.

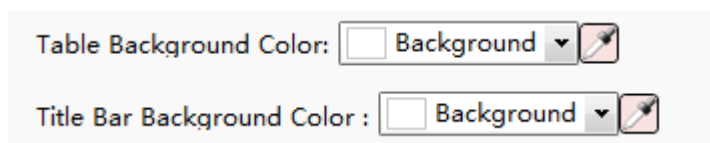

- Outline Style, Split Line Style, Line Width and Line Color

You can change the type of the out line and the split line, the line width and the line color.

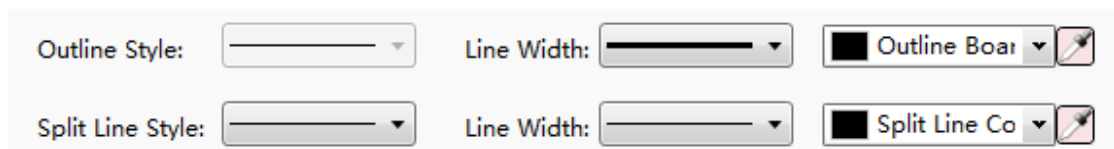

VEDA HCT User Manual

- Display Grid Line

After you check the option “Row Split Line” and the option “Column Split Line”, the appearance of the “User Privilege” component is shown as below.

Serial No.	User Name	User Privilege	Automatic Log-out Time
0	Admin	16	10

If the option “Row Split Line” and the option “Column Split Line” are unchecked, the appearance is shown below.

Serial No.	User Name	User Privilege	Automatic Log-out Time
0	Admin	16	10

4.6.4.6.3 Search

Check the option “Enable search”, and you can query the corresponding user privilege.

VEDA HCT User Manual

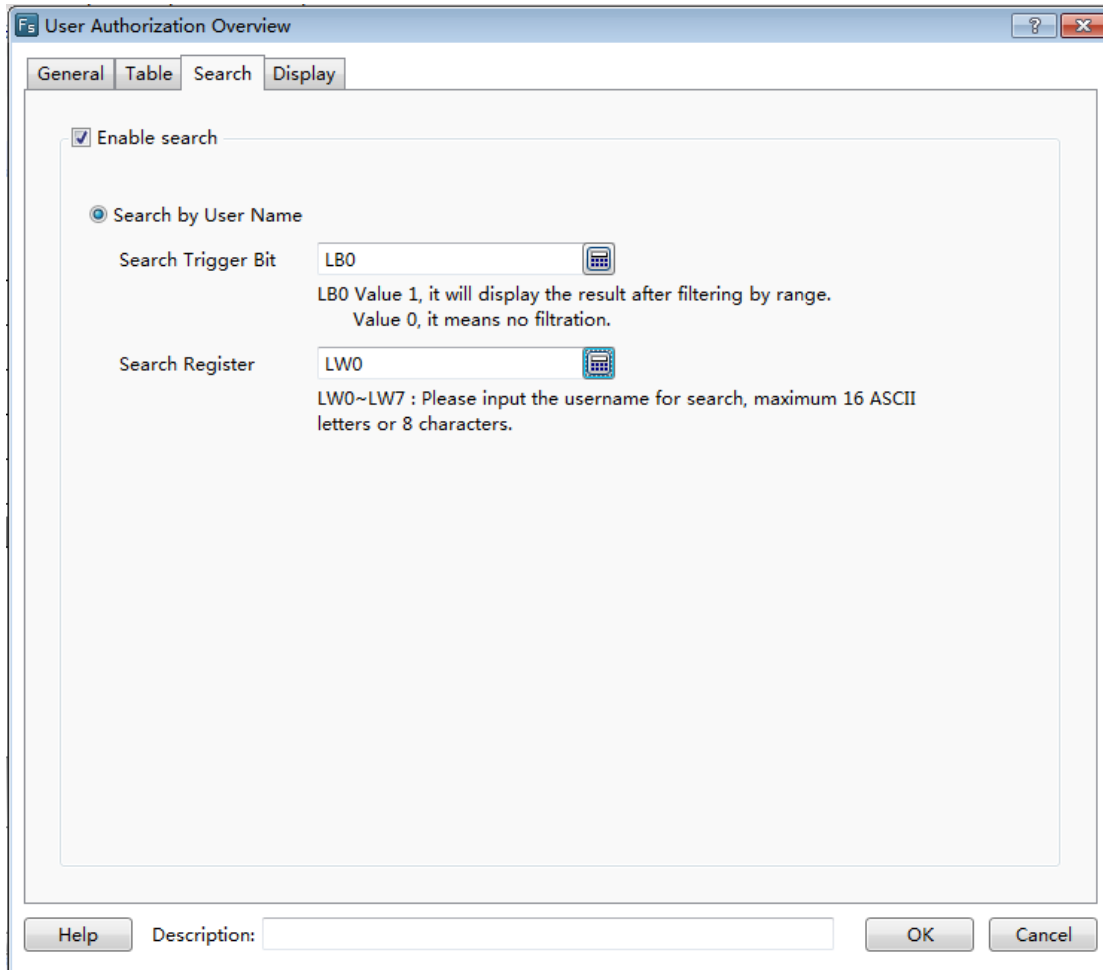

- Search Trigger Bit

A bit register needs to be set here. When the value of the bit register is "1", the result of filtering by a range is displayed. When the value of the bit register is "0", the displayed result is not filtered.

- Search Register

You need to specify a starting address of a set continuous 8 word registers here. You can input the corresponding user name to these registers to search. And the inputted user name should be no more than 16 ASCII letters or 8 ASCII characters.

4.6.4.6.4 Display

The settings of the "Display" property TAB are referred to: [Detailed manual/General functions/Drawing/Display](#).

4.6.5 Timer and Data Transmission

4.6.5.1 Timer

VEDA HCT User Manual

You can use the timer component to accomplish the tasks that need to be periodically executed or triggered under specific conditions.

The timer must be established on a window. When this window is working, the timer will work in accordance with the rules set. If you don't want the timer to be affected by the window switching, you can establish a timer on the common window.

For adding a timer, there are three ways. The first way is clicking the timer command from the "Component" menu. The second way is opening the property TAB of the window, then click the "Timer" property TAB. And the third way is clicking the "Timer" command from the shortcut tool bar.

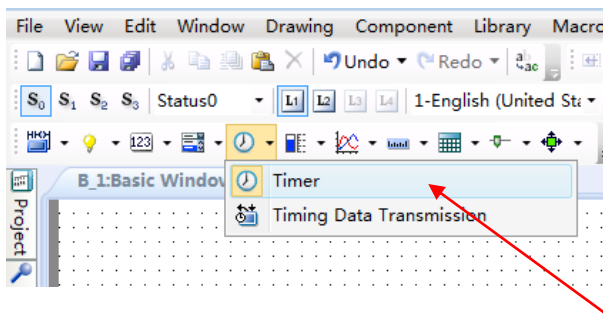
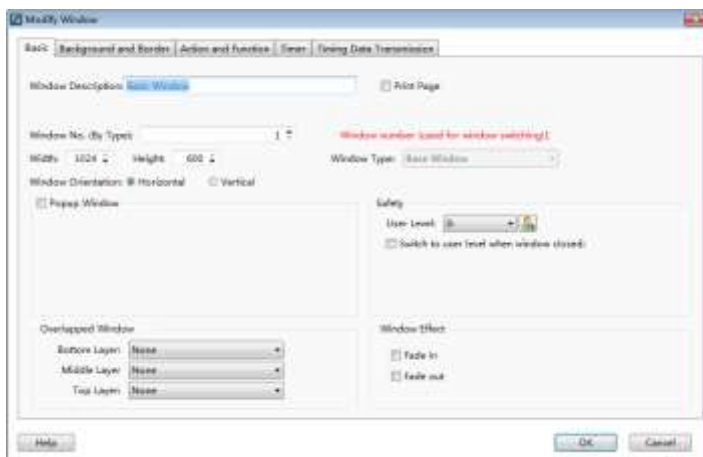
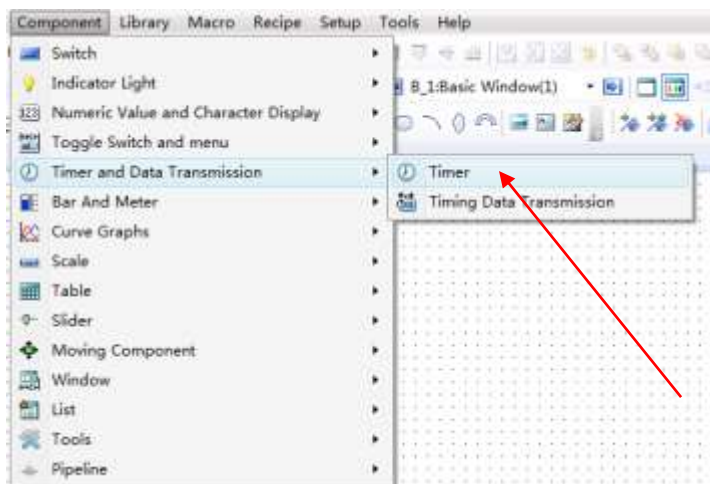

VEDA HCT User Manual

In the "Timer" property TAB, click the button "Add", you can open the detailed settings of the timer.

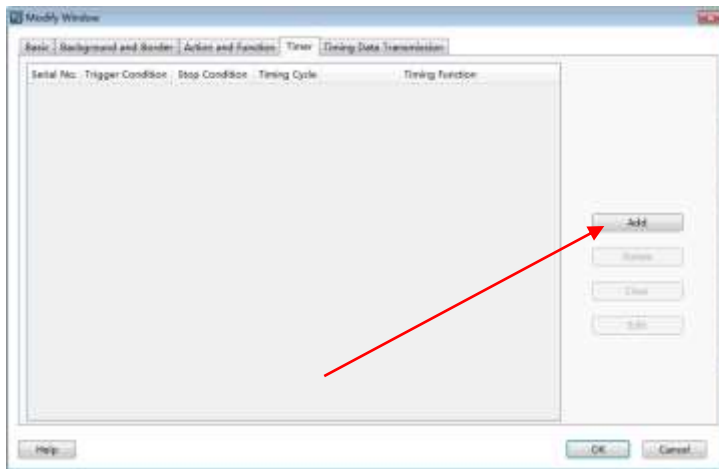

4.6.5.1.1 Trigger and Stop

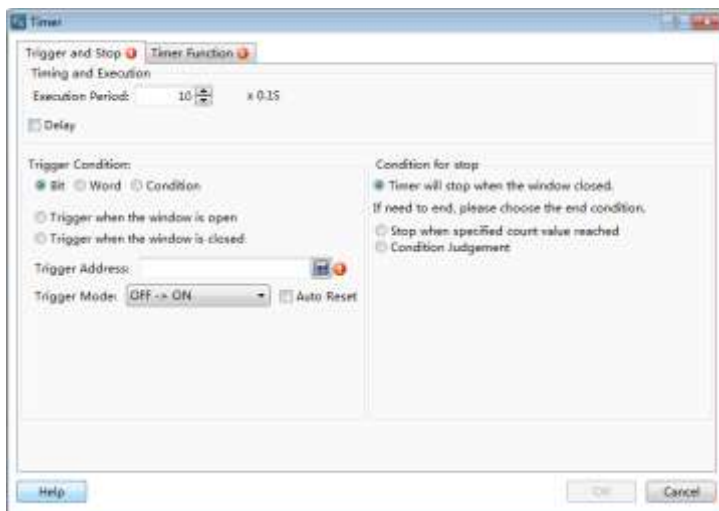

- **Timing and Execution**

Set the operation mode of the timer in Timing and Execution.

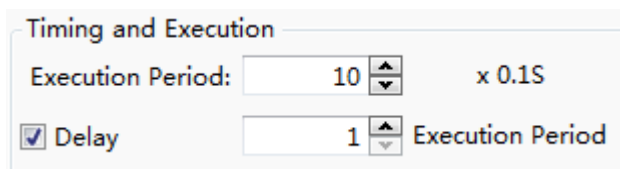

- **Execution Period**

Set the execution cycle of the timer, in 0.1 S (seconds). If you want to set the execution cycle in 10 seconds, you can set to 100x0.1S.

VEDA HCT User Manual

➤ Delay

In the case of unchecked “Delay” by default, when the trigger condition of the timer is met, the timer will execute immediately for the first time. After an interval of the setting execution cycle, the timer will execute for the second time until the end condition is met. If you want the timer to delay execution for a period of time when the trigger condition is met, you can check the “Delay” option, then delay time can be set to an integer times, such as three execution cycles.

● Trigger conditions

Trigger conditions is used to trigger the execution of the timer. There are many ways to trigger the timer in this software. You can choose according to your actual needs. It is important to note that the timer trigger mode should be edge trigger. After the trigger condition is met, the timer will continue working until the end condition is met.

➤ Bit

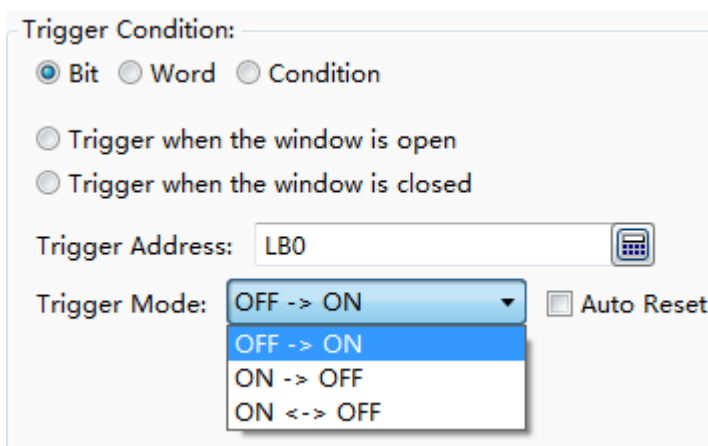

The screenshot shows a dialog box titled "Trigger Condition:". It has three radio buttons: "Bit" (selected), "Word", and "Condition". Below these are two more radio buttons: "Trigger when the window is open" and "Trigger when the window is closed". There is a text field for "Trigger Address:" containing "LB0" and a calculator icon. Below that is a dropdown menu for "Trigger Mode:" with options: "OFF -> ON" (selected), "OFF -> ON", "ON -> OFF", and "ON <-> OFF". To the right of the dropdown is a checkbox for "Auto Reset".

After select the “Bit” option, you can specify a bit register in the “Trigger Address” to control the timer trigger. The “Trigger Mode” can be set “OFF→ON”, “ON→OFF”, or “ON←→OFF”. For example, if you set “OFF→ON”, that means the timer is triggered when the register value changes from 0 to 1.

The “Auto Reset” refers to that the register value is automatically changed to OFF after the timer is triggered (for the “OFF→ON” trigger mode). The “ON ←→ OFF” trigger mode does not have the “Auto Reset” option.

➤ Word

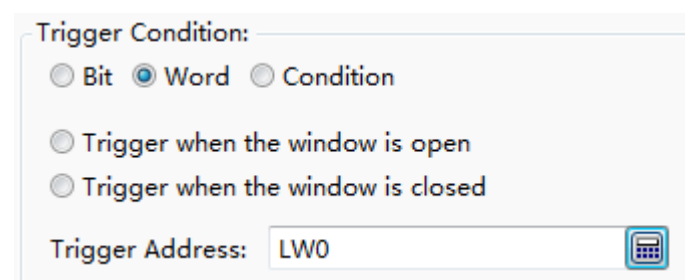

The screenshot shows a dialog box titled "Trigger Condition:". It has three radio buttons: "Bit", "Word" (selected), and "Condition". Below these are two more radio buttons: "Trigger when the window is open" and "Trigger when the window is closed". There is a text field for "Trigger Address:" containing "LW0" and a calculator icon.

VEDA HCT User Manual

After selecting the “Word” option, you can specify a word register to control the timer trigger. When the value of the specified register is changed, the timer execution will be triggered.

➤ Condition

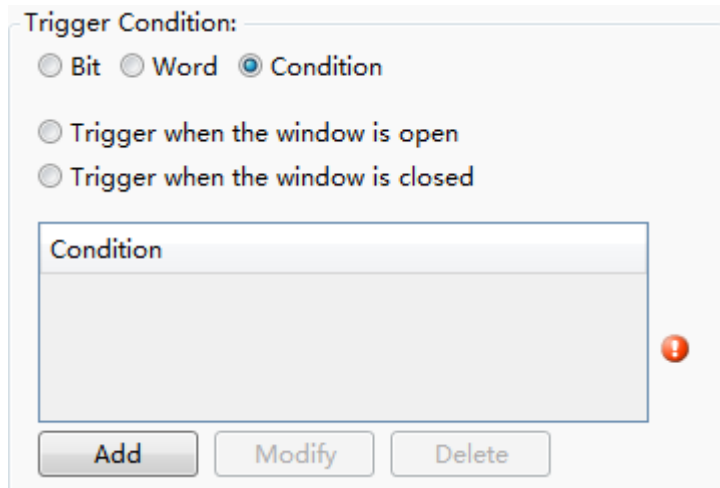

The screenshot shows a dialog box titled "Trigger Condition:". It contains three radio buttons: "Bit", "Word", and "Condition", with "Condition" selected. Below these are two more radio buttons: "Trigger when the window is open" and "Trigger when the window is closed". A text area labeled "Condition" is empty, with a red exclamation mark icon to its right. At the bottom are three buttons: "Add", "Modify", and "Delete".

If you select “Condition” option, you can use a set of conditions to control the timer trigger. For the logical condition editing, see: [Detailed manual/General functions/Drawing/Logic Control](#).

➤ Trigger when the window is open

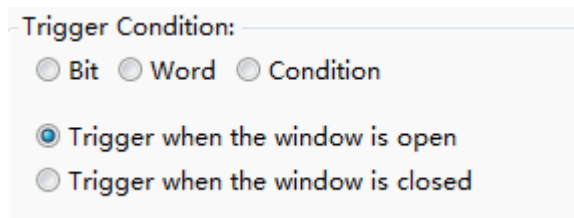

The screenshot shows the "Trigger Condition:" dialog box. The "Condition" radio button is unselected. The "Trigger when the window is open" radio button is selected. The "Trigger when the window is closed" radio button is unselected.

When the window in which the timer is located is opened, the timer execution will be directly triggered. Note that if the timer is located in the Public Window, only trigger once when the user project is executed after powering on the HMI, and it will not be triggered when switching to another window.

➤ Trigger when the window is closed

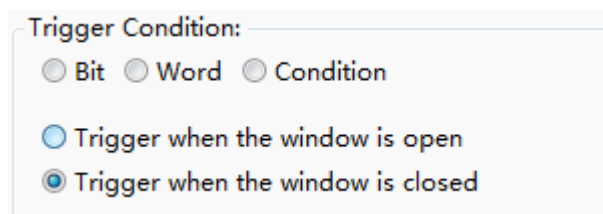

The screenshot shows the "Trigger Condition:" dialog box. The "Condition" radio button is unselected. The "Trigger when the window is open" radio button is unselected. The "Trigger when the window is closed" radio button is selected.

When the window in which the timer is located is closed and the other window is opened, the timer execution is triggered.

- Condition for stop

VEDA HCT User Manual

The condition for stop refers to the condition under which the timer stops execution. It is same to the “Trigger Condition”. The condition for stop is also edge-triggered.

- Timer will stop when the window closed

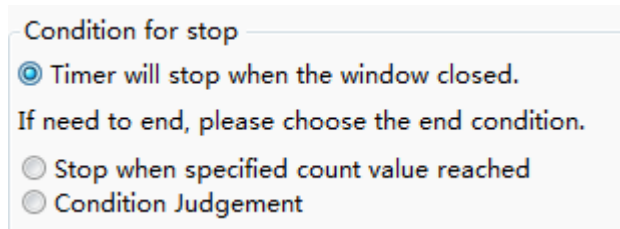

Condition for stop

Timer will stop when the window closed.

If need to end, please choose the end condition.

Stop when specified count value reached

Condition Judgement

The “Condition for stop” of the timer is “Timer will stop when the window closed” by default. If you want to end the timer execution in advance, select the other condition for stop:

- Stop when specified count value reached

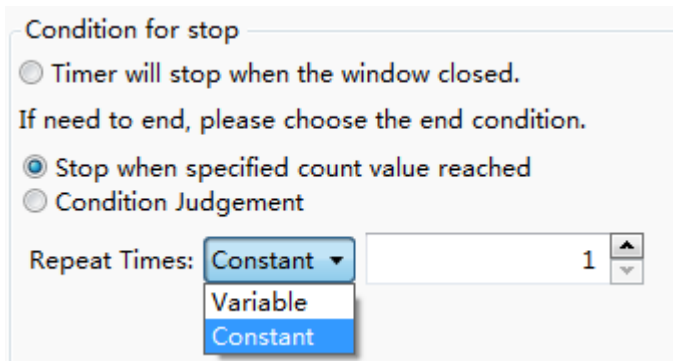

Condition for stop

Timer will stop when the window closed.

If need to end, please choose the end condition.

Stop when specified count value reached

Condition Judgement

Repeat Times: Constant

Variable

Constant

You can use the condition for stop to make the timer end automatically after repeating the specified number of times. Wherein, for the specified number of times, you can directly enter it by Constant, or you can specify a word register to control the timer execution times by Variable.

Note: When the trigger condition is "Trigger when the window is closed," the condition for stop will be directly selected as the “Stop when specified count value reached” and the number of times is set to 1 and not editable. This kind of timer can only be executed once.

- Condition Judgment

VEDA HCT User Manual

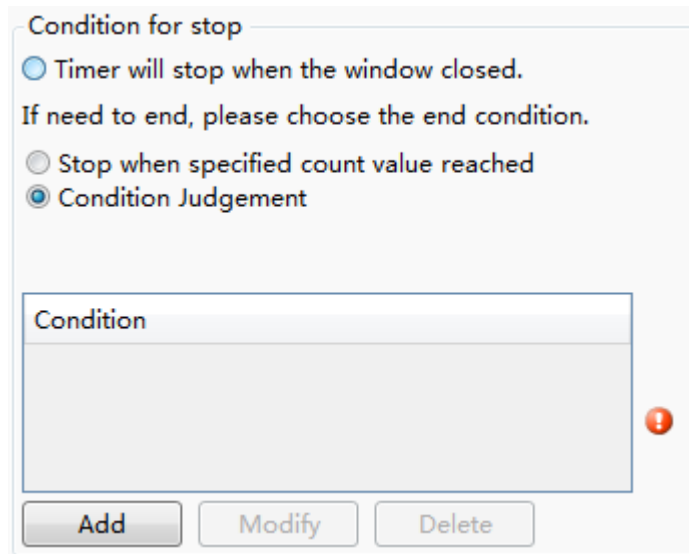

You can control the timer to end by using a set of conditions. When the conditions are satisfied, the timer execution ends. For the logical condition editing, see: [Detailed manual/General functions/Drawing/Logic Control.](#)

4.6.5.1.2 Timer Function

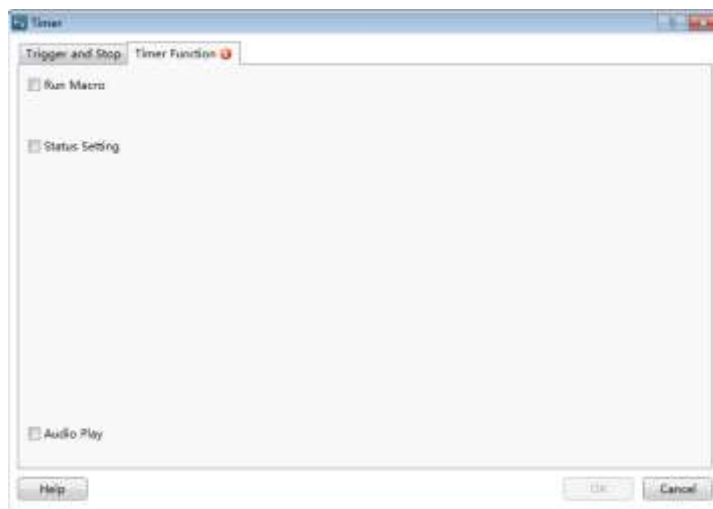

Click the "Timer Function" tab and open the "Timer Function" property TAB.

- Run Macro



You can use the timer to trigger the execution of macro instructions. If the macro instruction hasn't been established in the project, you can't check this box. You need to

VEDA HCT User Manual

click the "Macro Code" to open the Macro Code Editor Window and add the macro code. If the macro instruction is already exist, you can select the established macro from the drop-down list. Click the "Edit" button, you can directly open the Macro Code Editor Window to edit the currently selected macro instruction.

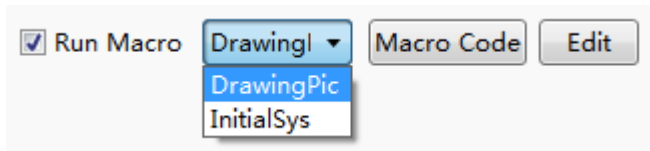

- Status Setting

The "Status Setting" function is used to set a bit register or set the value of a word register.

Whether setting the bit register status or setting the word register value, you first need to set the target address. For the address setting, refer to: [Detailed manual/General functions/Address editor](#).

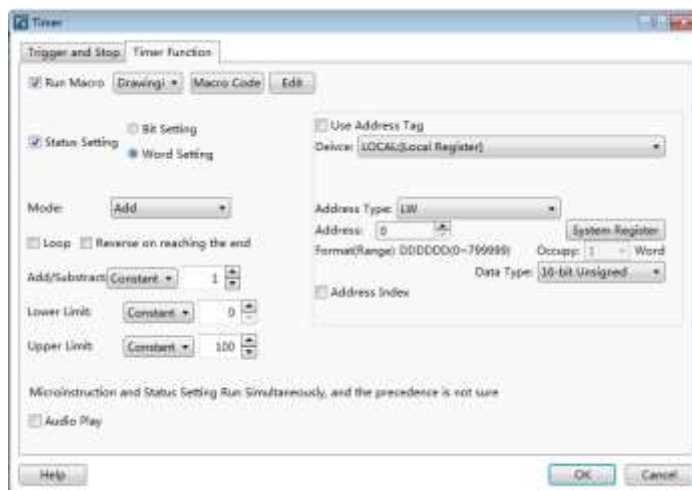
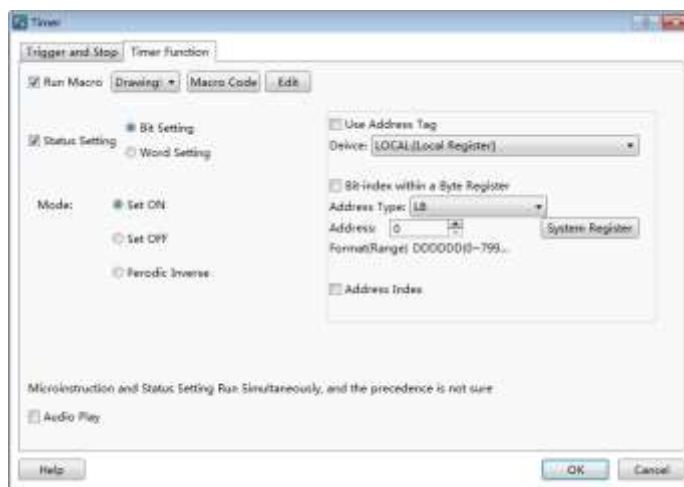

VEDA HCT User Manual

➤ Bit Setting

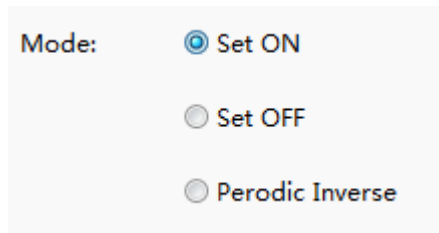

Mode: Set ON
 Set OFF
 Periodic Inverse

The mode of the Bit Setting includes “Set ON”, “Set OFF” and “Periodic Inverse”. The “Set ON” means that the bit is set ON when the timer is triggered and the bit remains ON in each execution period. The rules of “Set OFF” are same to the “Set ON”. The “Periodic Inverse” refers that when the timer is triggered, the bit is inverted and continues to invert in each execution cycle. For example, the timer executed once per second switches the LB0 bit. LB0 will change the state once per second, 1 second is ON and 1 second is OFF.

➤ Word Setting

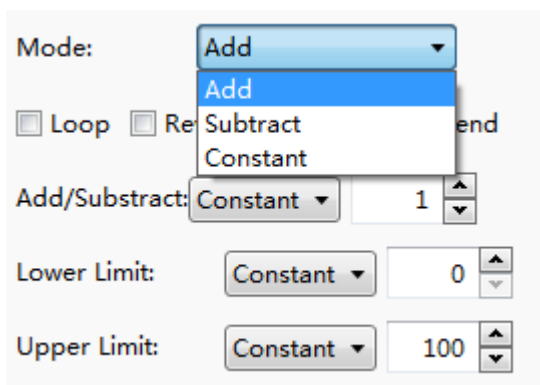

Mode: (dropdown menu open with options: Add, Subtract, Constant)
 Loop Repeat
Add/Subtract:
Lower Limit:
Upper Limit:

Word setting refers to periodic setting of a word register by timer. The setting modes include “Add”, “Subtract” and “Constant”.

● Audio Play

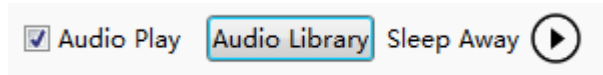

Audio Play Sleep Away

For the HMI device with an audio output function, you can use the timer to play sound. Click the "Audio Library", and select the audio file to be played from the “Audio Library”. This software supports audio files in MP3 and WAV format. For adding audio files, please

refer to: [Detailed manual/Library/Audio Library](#). Click the triangle play button  at the back of audio file, you can hear the audio file.

Note:

VEDA HCT User Manual

The “Run Macro”, “Status Setting” and “Audio Play” options can be checked at the same time. The timer can simultaneously control the execution of the three. However the execution order is uncertain.

4.6.5.2 Timing Data Transmission

A single or batch data can be transmitted by timing. The action can be triggered or executes periodically. This component is similar to the timer. You need to add it to a specified window. If you want a global execution, you can add it to the public window.

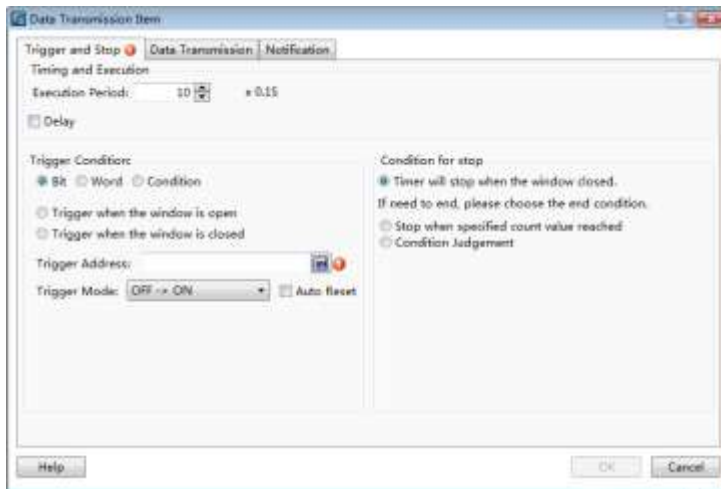

4.6.5.2.1 Trigger and Stop

The “Trigger and Stop” is used to control the execution modes of components. The modes of “Trigger and Stop” include “Execution Period”, “Trigger Condition” and “Condition for stop”. The details can be refers to: [Detailed manual/Component/Timer and Data Transmissionn/Timer](#).

4.6.5.2.2 Data Transmission

Data transmission can set the data to be transmitted, including the type and the length of the data to be transmitted, source address and target, and so on.

4.6.5.2.3 Notification

Notification function is similar to the notification function in the “Control Setting” property TAB of some components. It is used for before-writing notification and after-writing notification. For the detailed settings, refer to: [Detailed manual/General functions/Drawing/Control settings](#).

VEDA HCT User Manual

4.6.6 Bar and Meter

4.6.6.1 Bar Chart

Apart from the slight difference of “Direction” as shown in the figure below, the other functions of the bar graph are the same as the Sector Chart. The detailed description is referred to: [Detailed manual/Component/Bar and Meter/Sector Chart](#).

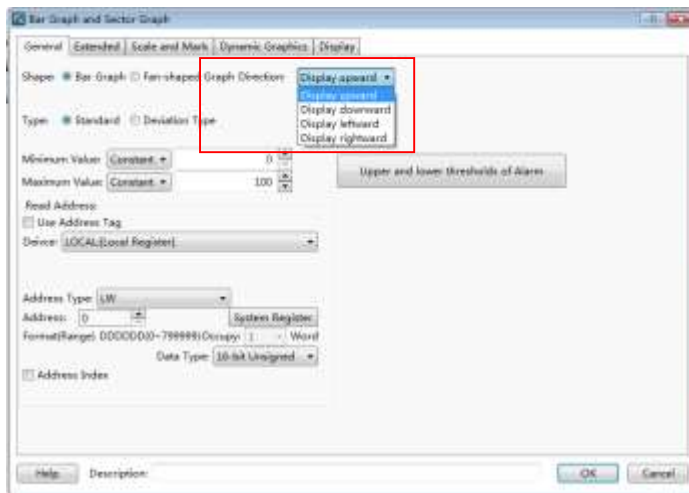

4.6.6.2 Sector Chart

Add a Sector Chart component by clicking the menu command “Component/Bar and Meter”. It is shown as below.

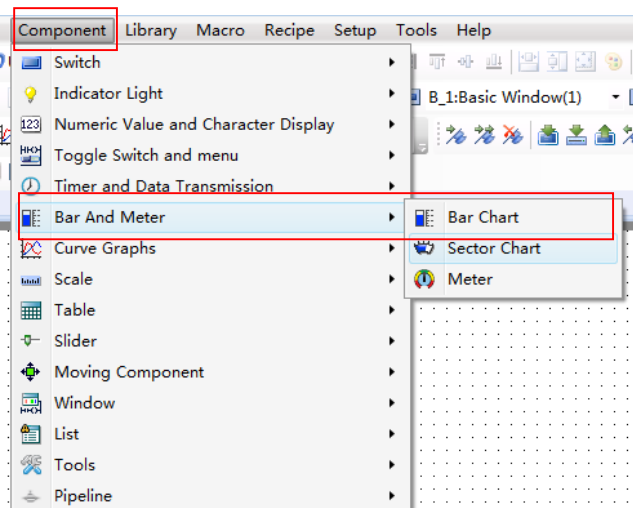

You can add the Sector Chart by clicking the corresponding shortcut button. It is shown as below.

VEDA HCT User Manual

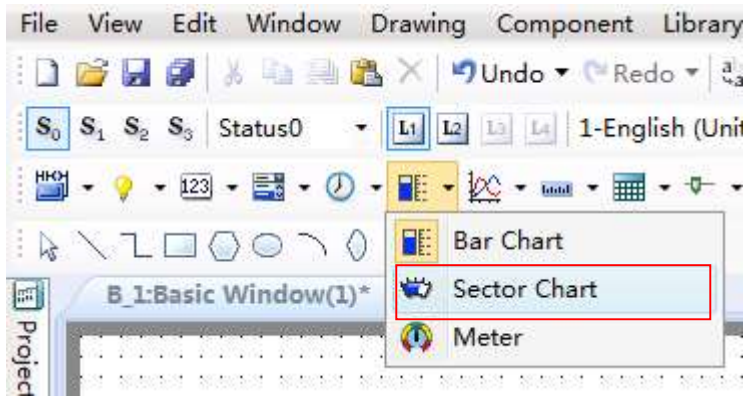

4.6.6.2.1 General

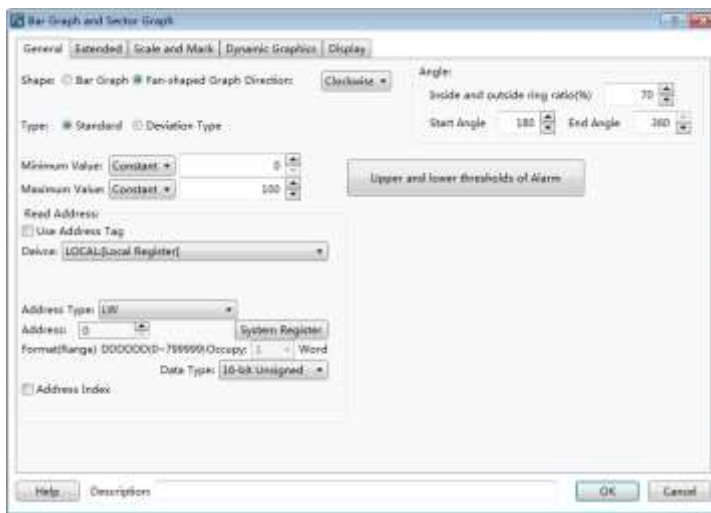

- Direction

The option “Direction” is used to set the starting point direction which refers to the fill direction of the sector chart.



As shown below, the left Sector Chart is filled by Clockwise, and the right Sector Chart is filled by Anti-clockwise.

VEDA HCT User Manual

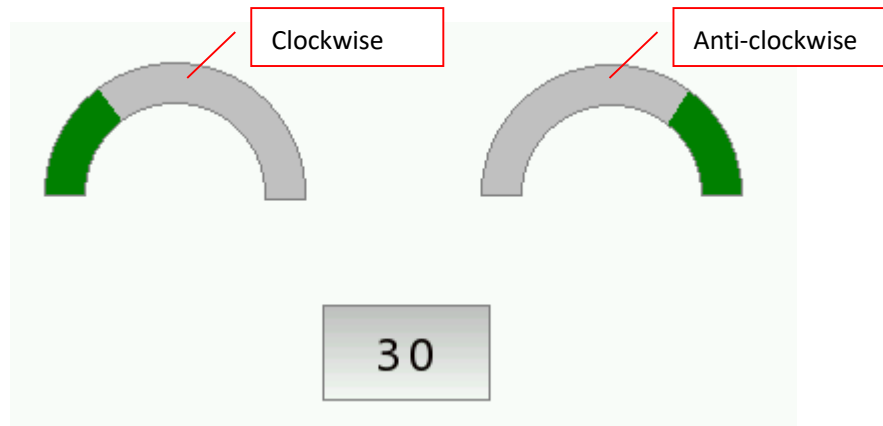

- Angle

The "Inside and outside ring ratio (%)" is set to a percentage of the inner ring radius to the outer ring radius. The "Start Angle" of the sector chart can be set at will. The effect is shown as below.

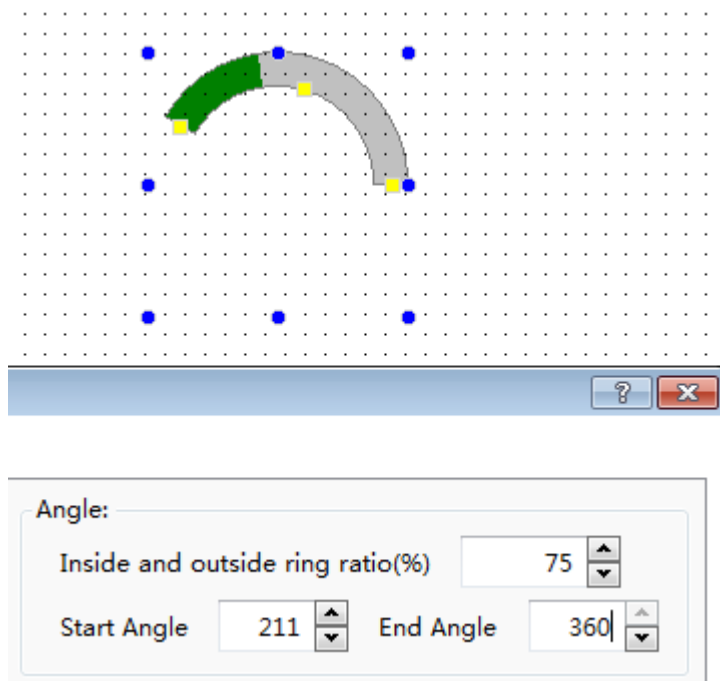

- Type

The types of the sector chart include "Standard" and "Deviation Type". The filling origin position of the standard sector chart is not adjustable. The origin position of the deviation type is adjustable. Here introduces the usage of bias type pie chart.

As shown as below, after selecting the Deviation Type, the "Origin Pos." can be freely set.



VEDA HCT User Manual

The running effects of the “Deviation Type” and the “Standard” are contrasted as shown as below (the left is deviation type, the right is standard type).

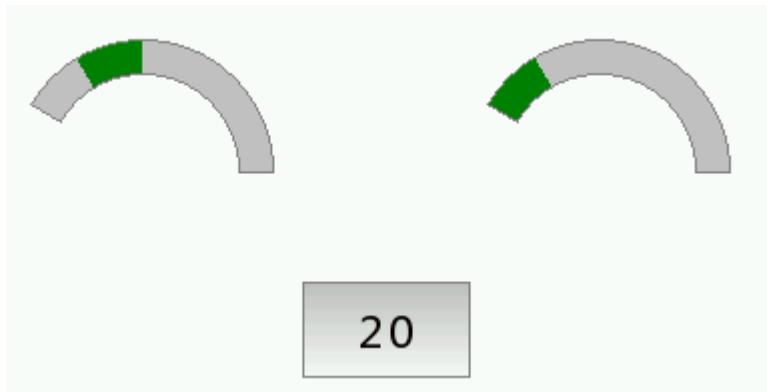

- Read Address

The detailed information is referred to: [Detailed manual/General functions/Address editor/Standard Byte Address Input.](#)

4.6.6.2.2 Extended

- Border Color and Background Color

As shown as below, the border color and the background color of the sector chart can be set freely. If the “Border Color” and “Background Color” are not checked, the border and the background color are not visible. The sector chart has three Fill Types: “Solid Color”, “Pattern” and “Gradient”. The Bar Color can be set freely.

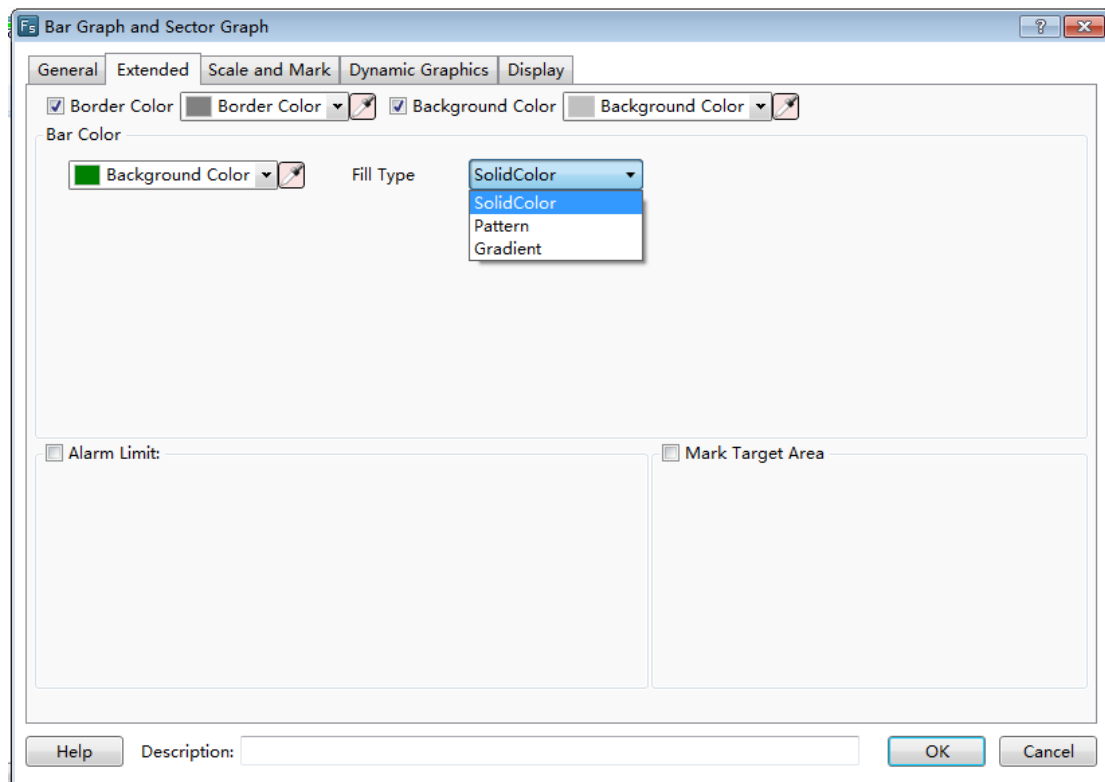

VEDA HCT User Manual

- Alarm Limit

As shown as below, you can set the upper and lower limit for alarm. Except for the “Blink” function, other functions are same to the “Meter”. The detailed settings are referred to: [Detailed manual/Component/Bar and Meter/Meter](#).

The screenshot shows the 'Alarm Limit' configuration panel. It includes a checked checkbox for 'Alarm Limit'. Below it are two rows for 'Lower Limit' and 'Upper Limit', each with a 'Constant' dropdown and a numeric input field (10 and 90 respectively). There are also two rows for 'Over Top Limit' and 'Over Lower Limit', each with a color selection dropdown (red and blue), a 'Background' dropdown, and a 'Blink' checkbox. A note at the bottom states: 'When the bar color is not pure color, foreground color and background color is needed to be set separately.'

- Mark Target Area

When the value enters into the specified Mark Target Area, the color of sector chart will be changed to the Target Area Color. The Target Value and Error Range can be set by Constant or by Variable.

The screenshot shows the 'Mark Target Area' configuration panel. It includes a checked checkbox for 'Mark Target Area'. Below it are two rows for 'Target Value' and 'Error Range', each with a 'Constant' dropdown and a numeric input field (0 and 0 respectively). There is also a 'Target Area Color' dropdown with a yellow color selection. A red box highlights the 'Error Range' dropdown menu, which shows 'Constant', 'Variable', and 'Constant' options.

The running results are as shown in the figure below. In this case, the Target Area Color is set yellow.

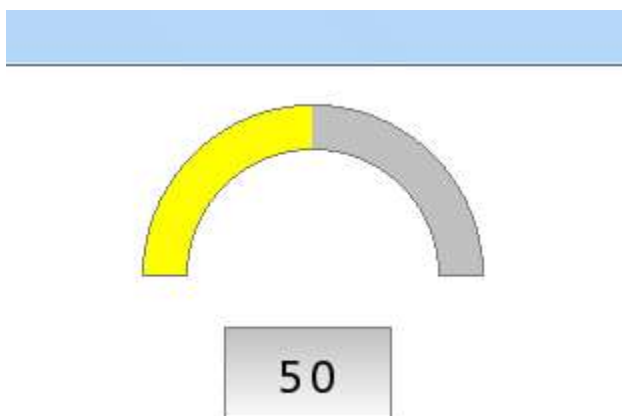

VEDA HCT User Manual

4.6.6.2.3 Scale and Mark

- Display the percentage

The function is used to display the total percentage of filling part to the entire sector chart. As shown as below, the display font size, font style and font color can be set freely.

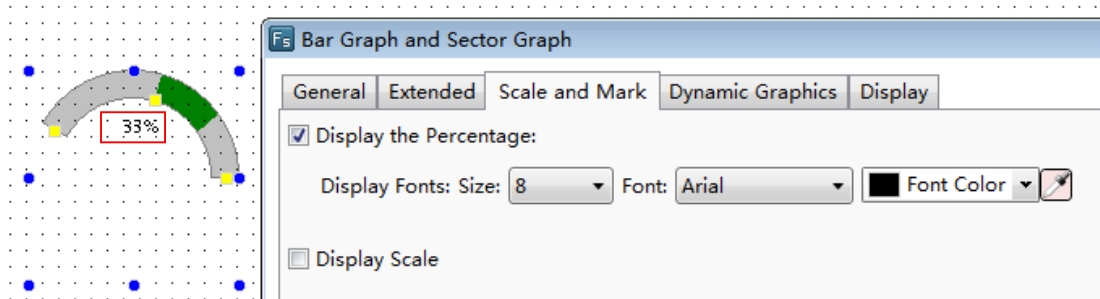

- Display Scale

The “Display scale” usage of the Sector Chart is same to the Meter but a slightly different, as shown as below. The detailed usage is referred to: [Detailed manual/Component/Bar and Meter/Meter](#).

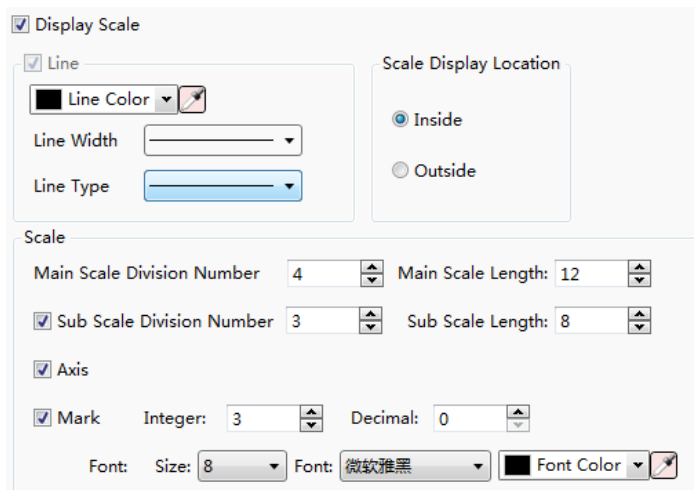

4.6.6.2.4 Display

The settings of the “Display” property TAB are referred to: [Detailed manual/General functions/Drawing/Display](#).

4.6.6.3 Meter

VEDA HCT User Manual

As shown as below, the Meter component can be added by clicking the menu command “Component/Bar and Meter”.

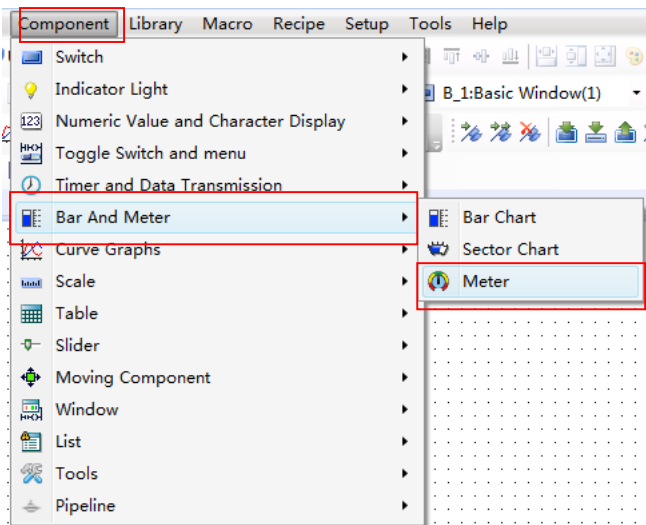

You can add a Meter component by clicking the corresponding tool button in the shortcut tool bar. It is shown as below.



4.6.6.3.1 General

VEDA HCT User Manual

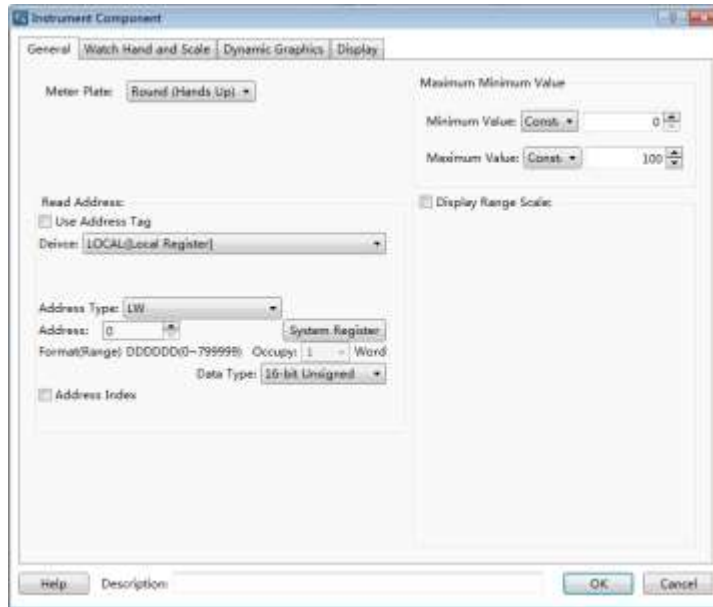

- **Meter Plate**

As shown as below, the Meter Plate includes five types: “Round (Hands Up)”, “Round (Hands down)”, “Upper Semi-Circle”, “Lower Semi-circle” and “Arc (Set Automatically)”.

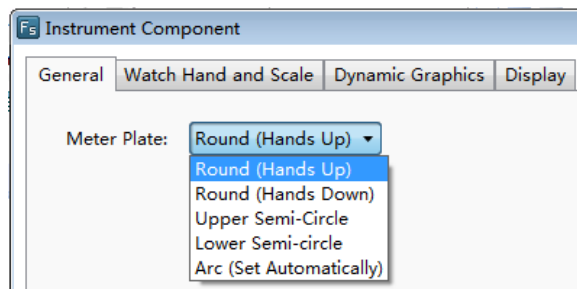

The attributes of the “Round (Hands Up)”, “Round (Hands down)”, “Upper Semi-Circle” and “Lower Semi-circle” are same. For the Arc Meter Plate, you can freely set the starting angle and ending angle, as shown as below.

VEDA HCT User Manual

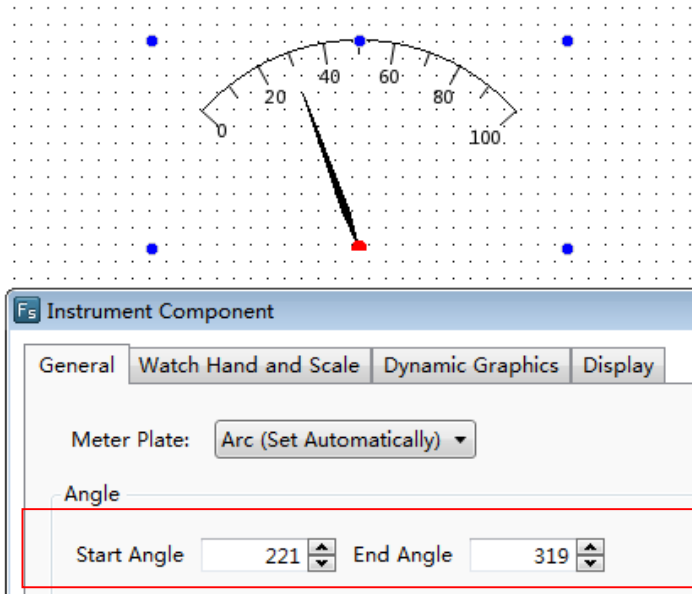

- Read Address

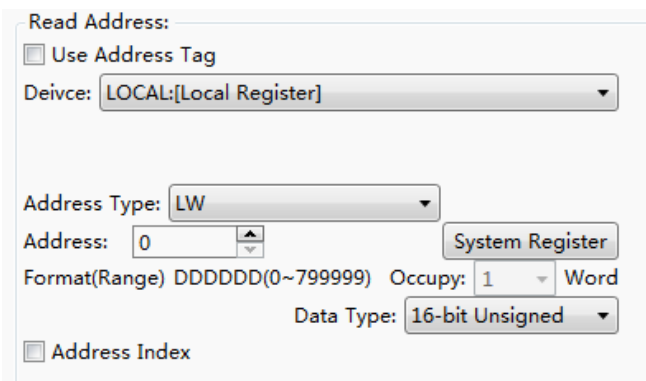

For details of Read Address, see: [Detailed manual/General functions/Address editor/Standard Byte Address Input.](#)

- Maximum Minimum Value

The Maximum Value and the Minimum Value of the Meter can be set by Constant or by Variable.

If you select by Constant, a fixed constant can be set in the position shown in the figure below.

VEDA HCT User Manual

Maximum Minimum Value

Minimum Value: Const:

Maximum Value: Const:

If you select by Variable, you can specify a word register and enter a value to the word register to change meter during running your project, as shown in the figure below.

Maximum Minimum Value

Minimum Value: Variat:

Maximum Value: Variat:

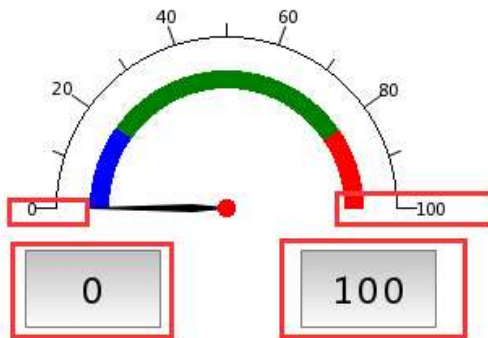

- Display Range Scale

Set the upper and lower limit for alarm on the position shown in the figure below. The limit value can be set by Constant or by Variable. After setting the upper and lower limit value, you can also set the colors for value within limit, below lower limit and above upper limit, as shown below.

VEDA HCT User Manual

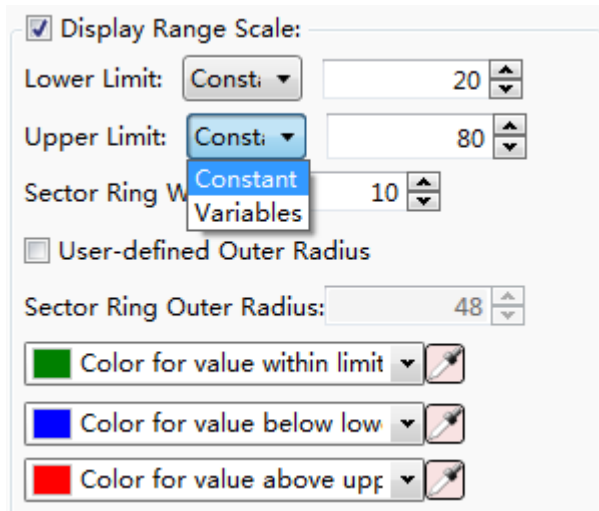

4.6.6.3.2 Watch Hand and Scale

- Color and Size

As shown in the figure below, the color of the Watch Hand and Watch Hand Axis, the length and width of the Watch Hand, and the radius of the Watch Hand Axis can be set.

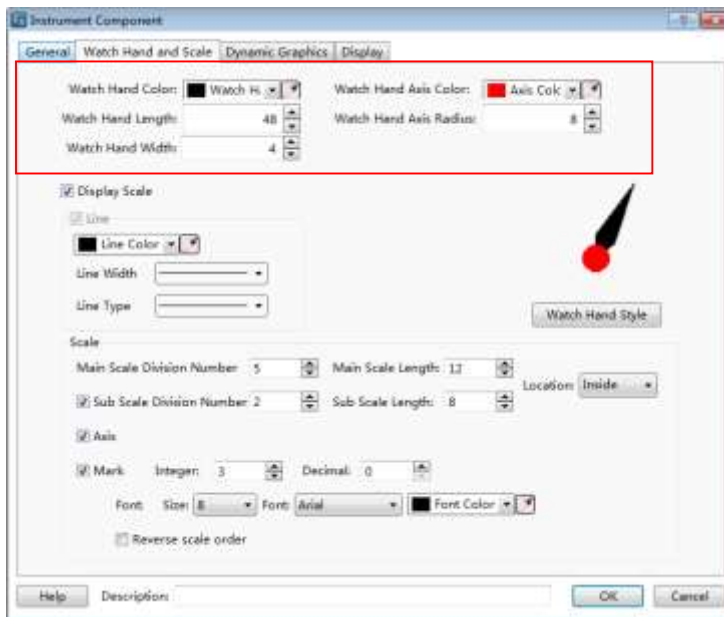

- Display Scale

As shown as the figure below, you can modify the color, the width and type of the meter scale line after the “Display Scale” is checked.

- Line

VEDA HCT User Manual

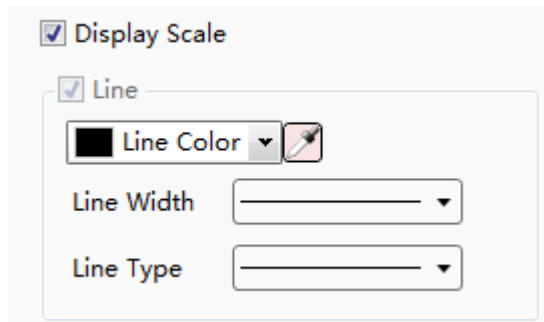

➤ Scale



You can set the “Main Scale Division Number”, the “Main Scale Length” and the “Sub Scale Length” here. The Location of the scale can be set “Inside”, “Outside” and “Center”, as shown as below. The “Sub Scale Division Number” and the “Axis” are checked by default. The default sub scale division number is 2. If the “Sub Scale Division Number” and the “Axis” are unchecked, that means the sub scale and axis are not displayed.



If the “Mark” is not checked, the meter will not display the scale value. After the “Mark” is checked, you can set the number of the integer digits and the decimal digits of the scale value and also can set the font styles of scale value. If you select the “Reverse scale order”, then the maximum value and the minimum value will switch their positions.

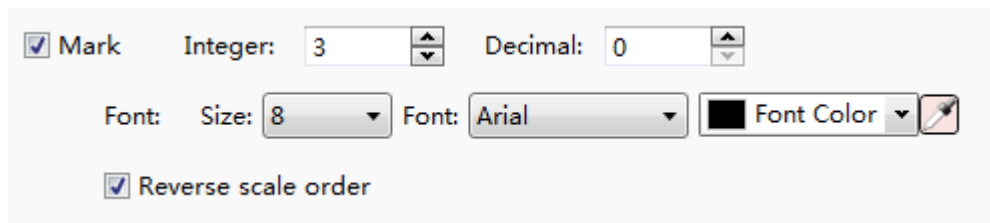

- Watch Hand Style

Click the button “Watch Hand Style”, you can select a style of watch hand for the meter.

VEDA HCT User Manual

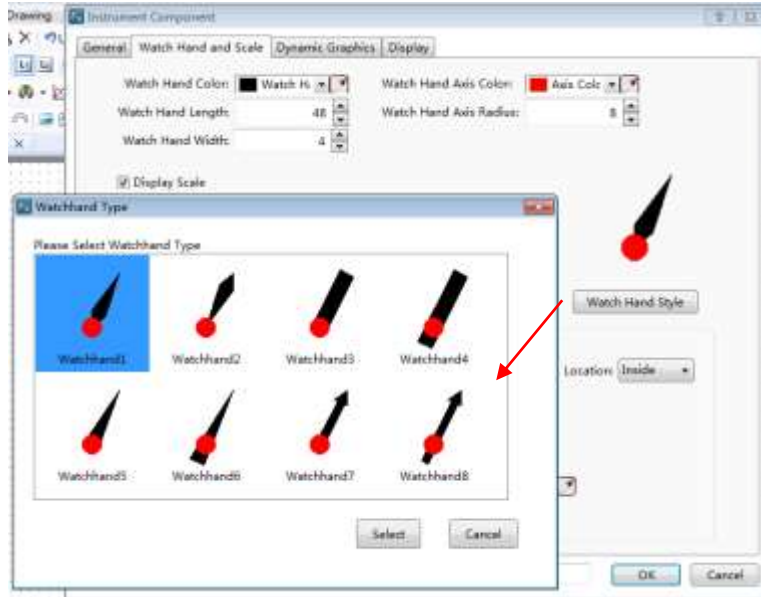

4.6.6.3.3 Display

The settings of the “Display” property TAB are referred to: [Detailed manual/General functions/Drawing/Display](#).

4.6.7 Curve Graphs

4.6.7.1 Trend Curve

The “Trend Graph” component is a curve formed by the sampling data.

4.6.7.1.1 General

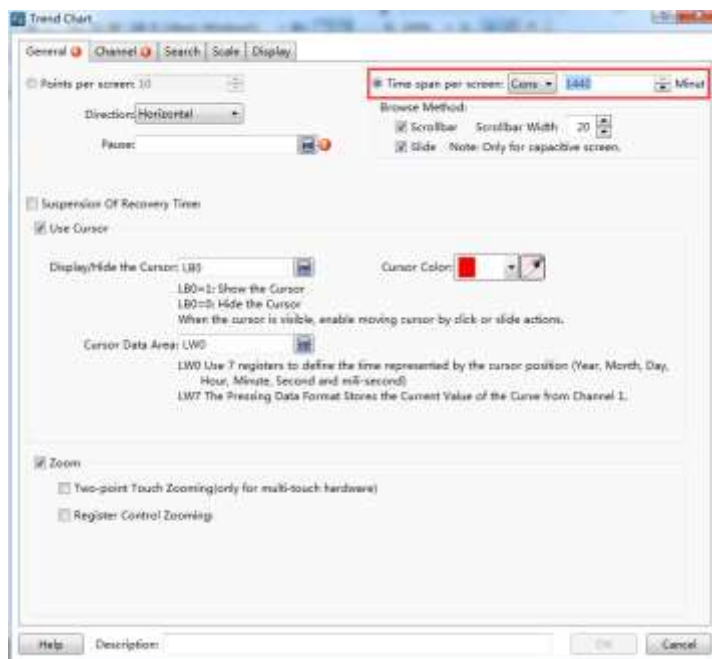

VEDA HCT User Manual

- Display Points of Each HMI

This option means the number of the displayed sampling data points on the screen. The default is 10. The max number of points can not more than the width of the used HMI resolution. For example, the 7-inch HMI device with the resolution 800*480 is used. Then the max number of points is 799.

- Direction

The option "Direction" is used to set the display direction of the trend curve. It is set "Horizontal" by default. It can be set "Vertical", too.

- Pause

A bit register address can be set here. When the bit register is ON, the trend curve is not refreshed (but the sampling is not paused). When it is OFF, the trend curve is refreshed in real time.

- Time range per screen

You can set the time axis range, there are constants and variables optional, variables are controlled through the register, maximum time can be set as 1440 minutes.





- Browse Method

The methods of "Scrollbar" and "Slide" are all supported to view the trend curve. You can check anyone or two. But the "Slide" is only valid for the capacitive HMI device.

- Use Cursor

You can check the option "Use Cursor". This option is used to view the trend data crossed by the cursor and the data sampling time. The settings are shown as below.

Use Cursor

Display/Hide the Cursor: LB1  Cursor Color:   

LB1=1: Show the Cursor
LB1=0: Hide the Cursor
When the cursor is visible, enable moving cursor by click or slide actions.

Cursor Data Area: LW0 

LW0 Use 7 registers to define the time represented by the cursor position (Year, Month, Day, Hour, Minute, Second and milli-second)
LW7 The Pressing Data Format Stores the Current Value of the Curve from Channel 1.

➤ Display/Hide the Cursor

VEDA HCT User Manual

Here you can set a bit register. If the bit register is ON, the cursor is displayed. If it is OFF, the cursor is hidden. When the cursor is visible, you can click or slide to move the cursor.

➤ Cursor Color

The default color of the cursor is red. You can modify it according to the actual needs.

➤ Cursor Data Area

You need to set a starting address of a continuous word registers area here to save the information of the cursor data. The first 7 word registers save the sampling time of the trend data which is crossed by the cursor. They are year, month, day, hour, minute, second and millisecond. From the eighth register, the sampling data crossed by the cursor is saved. The data format should be consistent with which defined in "Data Sampling".

For example, the starting address of the cursor data area is set LW100. Then the registers from LW100 to LW106 save the sampling time information of year, month, day, hour, minute, second and millisecond. If the "Data Sampling" that you use only defines a data in "16-bit Unsigned" data type and the channel number is 1, then the LW107 register saves the sampled data at this time. If the "Data Sampling" that you use has the data sampled from two channels, the data type of the first channel is "Single precision floating point number" and the second channel is "16-bit Unsigned", then LW107 (Single precision floating point number) saves the data of the first channel and LW109 (16-bit Unsigned) saves the data of the second channel. Other data formats can be done in the same matter.

● Use Zoom

This option is optional. After it is checked, the option "Two-point Touch Zooming (only for multi-touch hardware)" can be checked. This option is only valid for the capacitive HMI device. After you enable this function, the curve will be zoomed out when two fingers slide outward in the curve zone and the curve will be zoomed in when two fingers slide inward in the curve zone.

The option "Register Control Zooming" is used to zoom by using a word register. After checked it, a word register needs to be given here. The value of this word register is the percentage of zooming. For example, the value of the word register is 50. It means that only 50% is displayed and the curve is scaled a half. If the value of the word register is 200, it means 200% is displayed and the curve is zoomed to 2 times. The settings are shown as below.

VEDA HCT User Manual

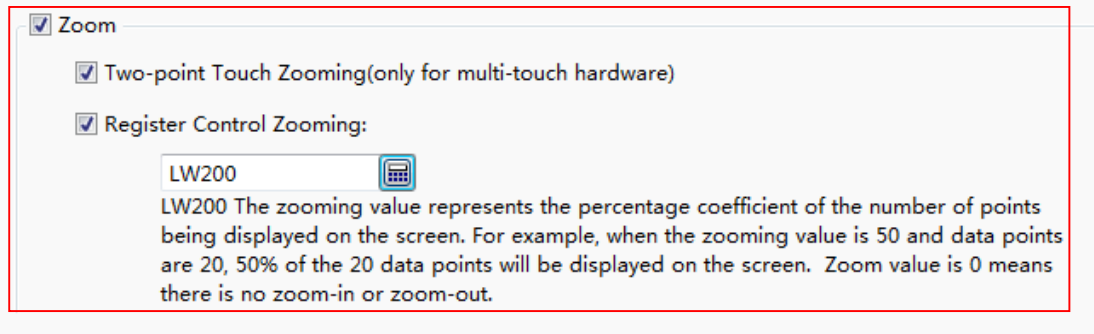

4.6.7.1.2 Channel

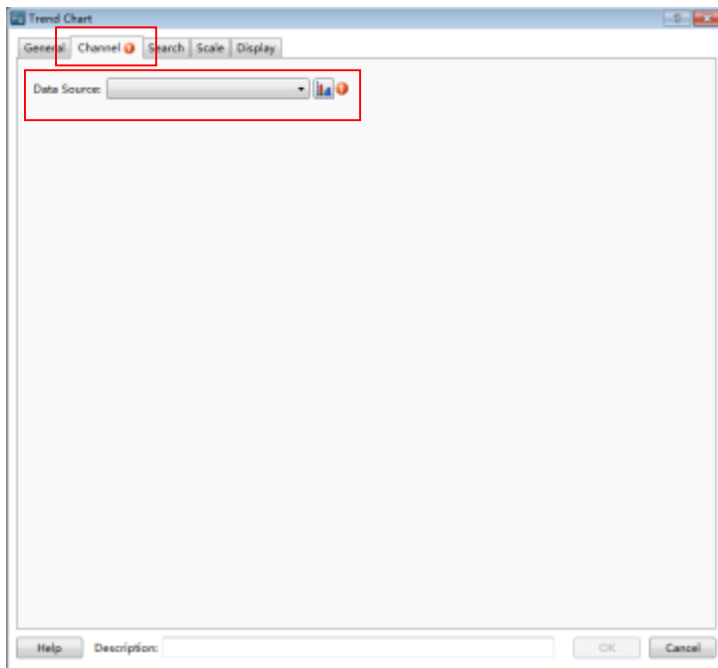

In the "Channel" property TAB, you need select a sampling data as the "Data Source". There will be a red exclamation mark here if the "Data Sampling" is not set. You can open the "Data Sampling" settings page to set the required sampling data by click the button

". After the setting is complete, the "Channel" page is shown as below.

VEDA HCT User Manual

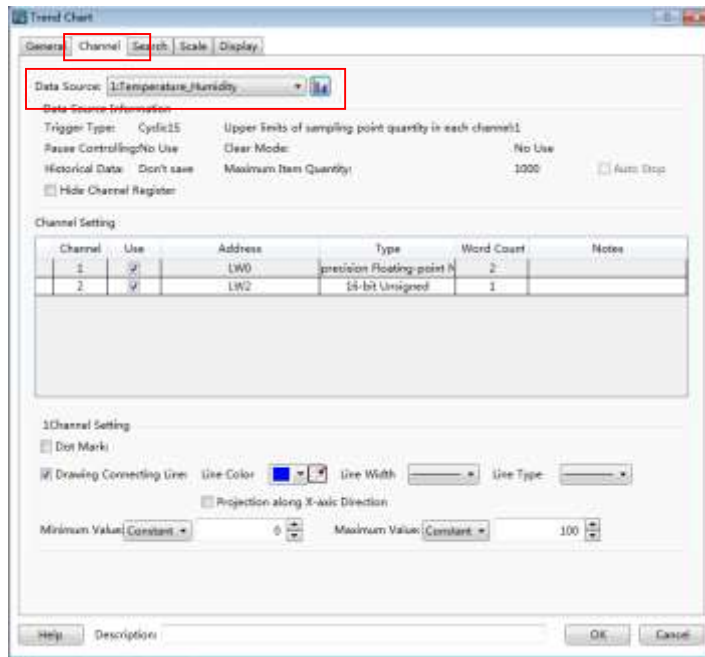

After you selecting a sampling data for the option "Data Source", all channels of this sampling data defined in the "Data Sampling" will be displayed in the "Channel Setting" property box.

For the above figure, the sampling data "Temperature Humidity" is selected as the data source. This sampling data has two channels. The data of channel 1 is from LW0 register and the data type is "Single precision floating point number". The data of channel 2 is from LW2 register and the data type is "16-bit Unsigned".

- Data Source Information

In this area, you can see the various attributes of the selected sampling data defined in the "Data Sampling".

There is an option "Hide Channel Register" here. After it is checked, you need to specify a word register. When the bit0 of this word register is ON, hide the curve of Channel 1. When the bit1 is ON, hide the curve of Channel 2. Other channels can be done in the same matter. The setting is shown as below.

VEDA HCT User Manual

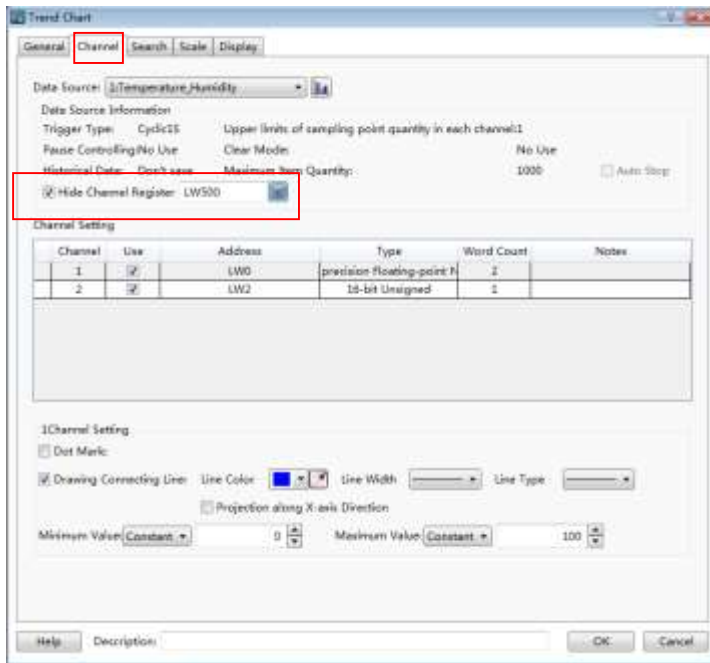

For example, the option “Hide Channel Register” is set LW500. Then the curve of Channel 1 is hidden when the bit 0 of the LW500 is ON. The curve of Channel 2 is hidden when the bit1 of the LW500 is ON.

- Channel Setting

All channels of the data source are displayed here. They are all checked in the “Use” Column by default. It means they are all set to display on the trend curve.

Note:

If one channel is not checked in the "Use" column, that means the data of this channel will not be displayed on the trend curve. So the corresponding bit of the word register specified in the option “Hide Channel Register” cannot control the curve of this channel to display or hide.

Click one channel in the "Channel Setting" area, the relevant attribute settings of this channel will be displayed below. It is shown as below.

VEDA HCT User Manual

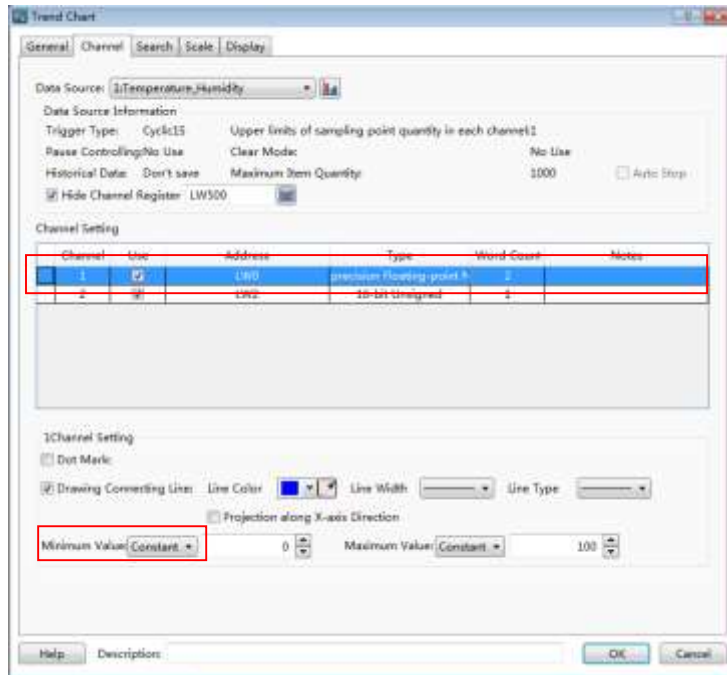

➤ Dot Mark

This option is not checked by default. After it is checked, you can set the dot color, the dot size and the dot style for each point of the sampling data.

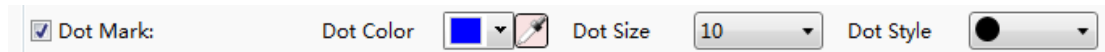

➤ Drawing Connecting Line

This option is checked by default. If it is checked, you can set the line color, the line width and the line type for the connecting line of the sampling data points.

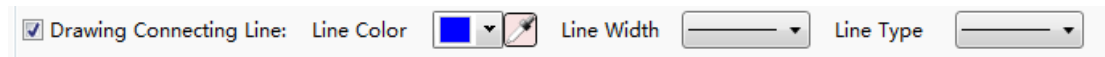

➤ Projection along X-axis Direction

This option is not checked by default. After it is checked, the trend curve from the first point to the current sampling point will project to the X-axis to form a closed figure.

For example, the option “Dot Mark” and the option “Projection along X-axis Direction” are all checked, the display effect is shown as below.

VEDA HCT User Manual

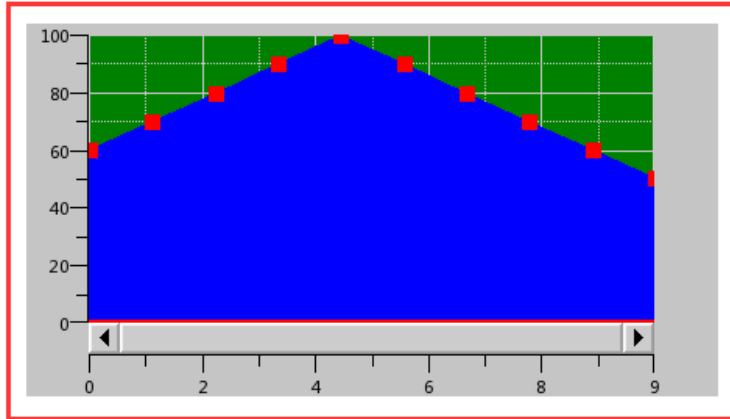

➤ Minimum Value

The minimum value of the trend curve can be set by Constant or by Variable. When set it by Variable, the data type of the specified word register should be consistent with the data type of the selected sampling data channel.

➤ Maximum Value

The maximum value of the trend curve can be set by Constant or by Variable. When set it by Variable, the data type of the specified word register should be consistent with the data type of the selected sampling data channel.

4.6.7.1.3 Search

The option “Enable Search Function” is not checked by default in the “Search” property TAB. After it is checked, the settings are shown as below.

VEDA HCT User Manual

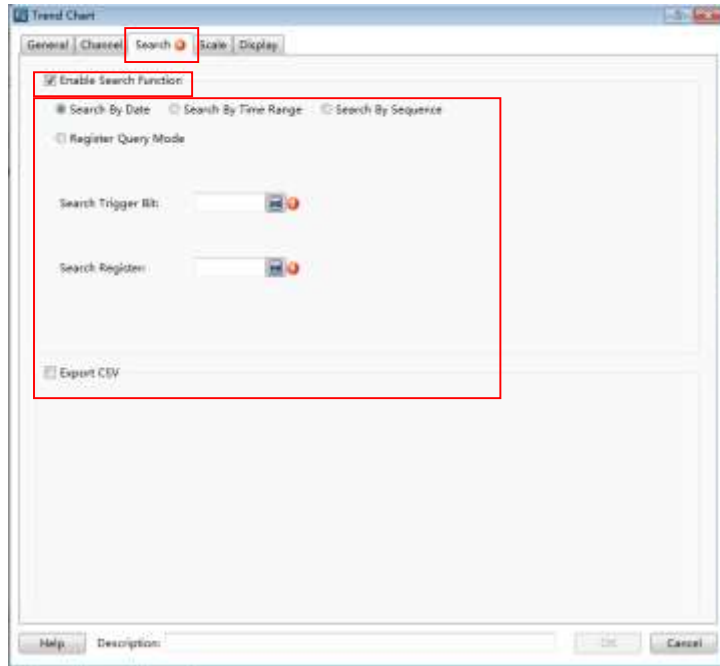

There are three fixed search modes supported: “Search By Date”, “Search By Time Range” and “Search By Sequence”. The “Register Query Mode” is a dynamic search mode. The default search mode is “Search By Date”.

➤ Search By Date

The settings of “Search By Date” are shown as below.

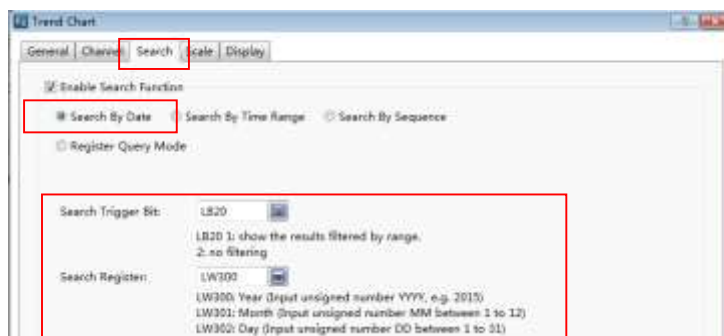

“Search Trigger Bit”

The option “Search Trigger Bit” is used to specify a bit register to trigger the search function. When the trigger bit is ON, the filtered results are displayed. When the trigger bit is OFF, the result which is not filtered is displayed.

“Search Register”

The “Search Register” is used to specify word registers to save the information of the search function. The number of the word registers is depending on the search mode.

VEDA HCT User Manual

You can get the information of the used word registers according to the text displayed under the specified address.

For example, select the "Search By Date" mode and specify LW300 for the option "Search Register". Then LW300 saves the search year, LW301 saves the search month and LW302 saves the search day. You can use three numeric value input components connected with the three word registers to give the search conditions in your project.

➤ Search By Time Range

For the "Search By Time Range" mode, the function and the setting of the "Search Trigger Bit" are same to the "Search By Date" mode. The difference is the "Search Register."

When selecting the "Search By Time Range" mode, you should specify a start address of a continuous 12 word registers area for the option "Search Register". The first six word registers save the start date of search, including year, month, day, hour, minute and second. The last six word registers save the stop date of search. The setting is shown as below.

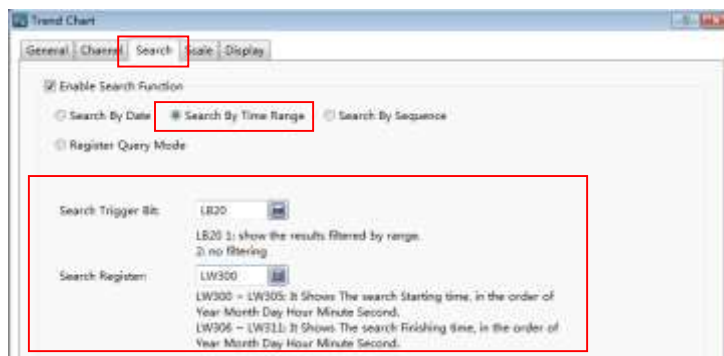

➤ Search By Sequence

For the "Search By Sequence" mode, the function and the setting of the "Search Trigger Bit" are same to the "Search By Date" mode. The difference is the "Search Register."

For example, select the "Search By Sequence" mode and specify LW300 for the option "Search Register". The settings are shown as below. Then when LW300 is 0, the data of the current day is displayed on the curve. When LW300 is 1, the data of the yesterday is displayed on the curve. Other values can be done in the same matter.

VEDA HCT User Manual

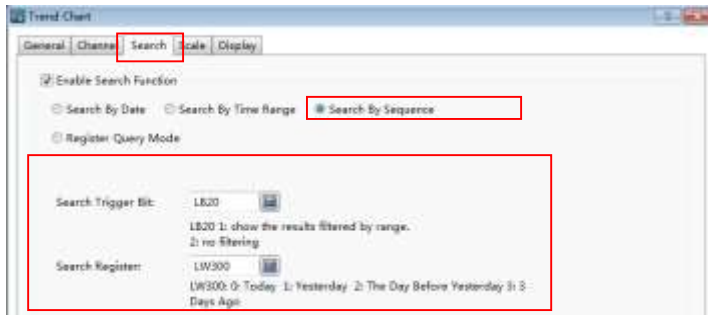

➤ Register Query Mode

The “Register Query Mode” is a dynamic search mode. When the “Register Query Mode” is selected, you can specify a word register to dynamically adjust the search mode. If the word register is 0, the “Search By Date” mode will be used. If it is 1, the “Search By Time Range” mode will be used. If it is 2, the “Search By Sequence” mode will be used. The settings are shown as below.

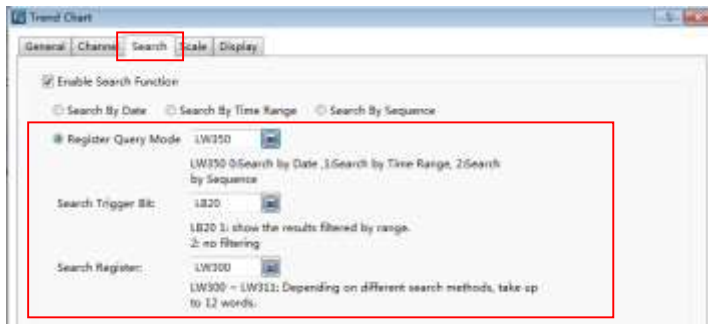

4.6.7.1.4 Scale

● X-axis Scale

The source of X-axis value can be set “Use Point Scale Value” or “Use Time Scale Value”. The default is “Use Point Scale Value”. It is shown as below.

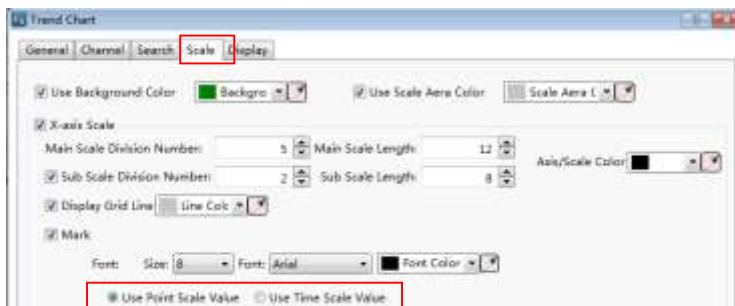

The option “Use Point Scale Value” means that the values of the sampling data points are used as the X-axis scale. The option “Use Time Scale Value” means that the time of the data sampling is used as the X-axis scale.

VEDA HCT User Manual

- X-axis Scale

The source of Y-axis value can be set “Use ... Channel Maximum Minimum Value” or “Self-setting”. The default is “Use 1 Channel Maximum Minimum Value”. It is shown as below.

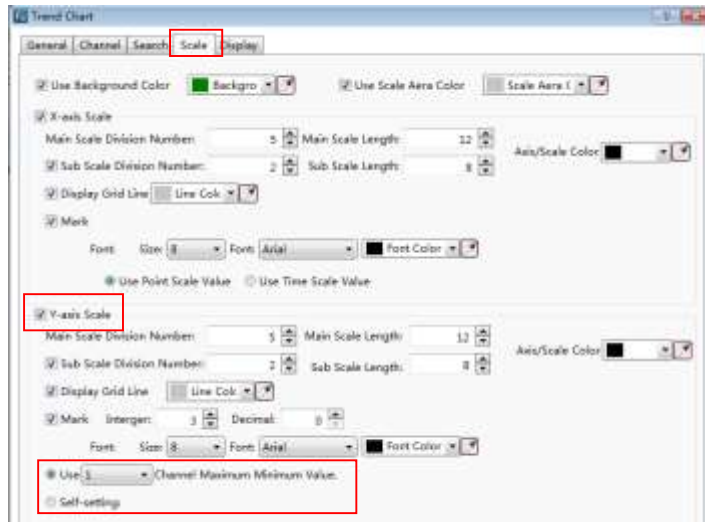

After you select the option “Use ... Channel Maximum Minimum Value”, you can specify a channel number. And the minimum and the maximum values of this channel will be used as the minimum and the maximum values of the Y axis.

If the option "Self-setting" is selected, you can set the maximum and minimum values by yourself as the source of Y-axis. The minimum and maximum values can be set by Constant or by Variable. The settings are shown as below.

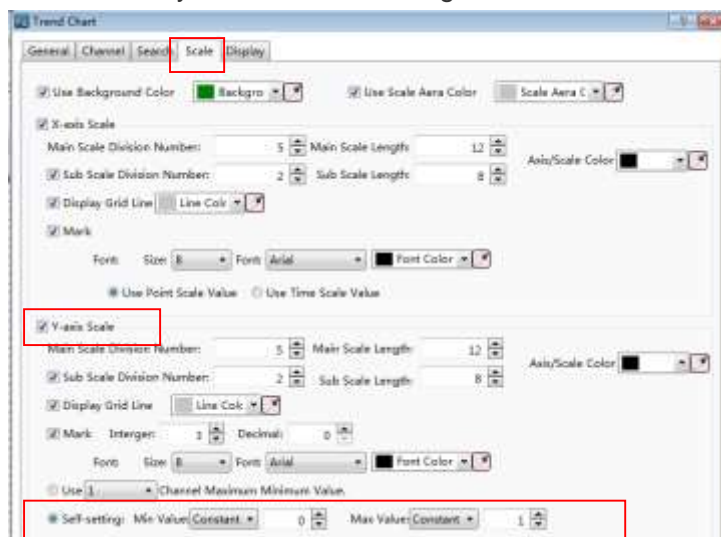

For more details, please refer to: Detailed manual/Component/Scale.

4.6.7.1.5 Display

VEDA HCT User Manual

The settings of the "Display" property TAB are referred to: [Detailed manual/General functions/Drawing/Display](#).

4.6.7.2XY Chart

The "XY Chart" refers to the curve formed by the corresponding data points which are comprised by a set of data registers or two different sets of data registers. All settings are described below.

4.6.7.2.1 General

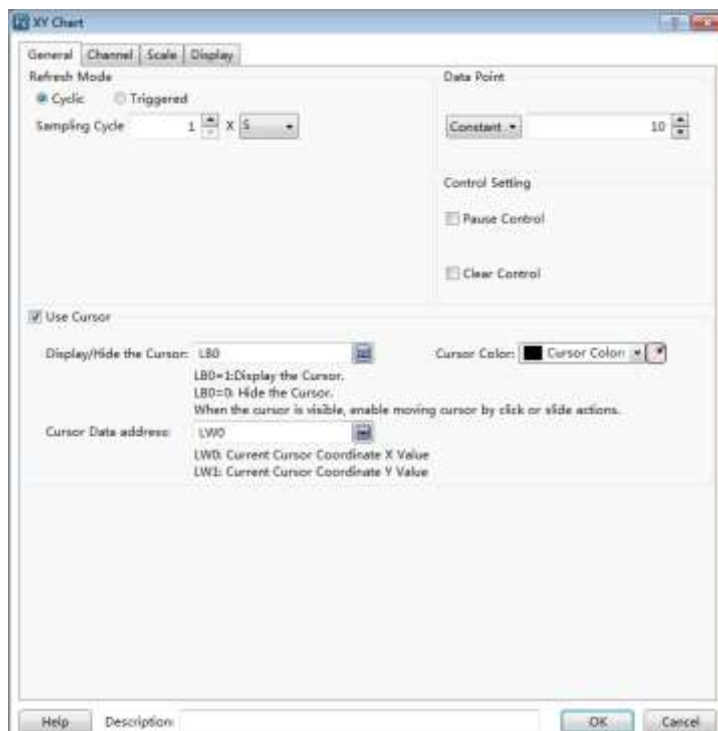

- **Refresh Mode**

The "Refresh Mode" includes two types: "Cyclic" and "Triggered".

- **Cyclic**

The default refresh mode is "Cyclic". The default sampling cycle period is 1 second. That means the curve is refreshed every 1 second. The minimum sampling cycle period is 0.1 second.

- **Triggered**

After you select "Triggered" refresh mode, you need to specify a bit register and select the "Trigger Mode". The Trigger Mode can be set "Bit" or "Word".

VEDA HCT User Manual

For the “Bit” trigger mode, there are three “Trigger Condition”: "OFF→ ON", "ON→OFF" and "OFF↔ON". You can choose one of them. The settings are shown as below.

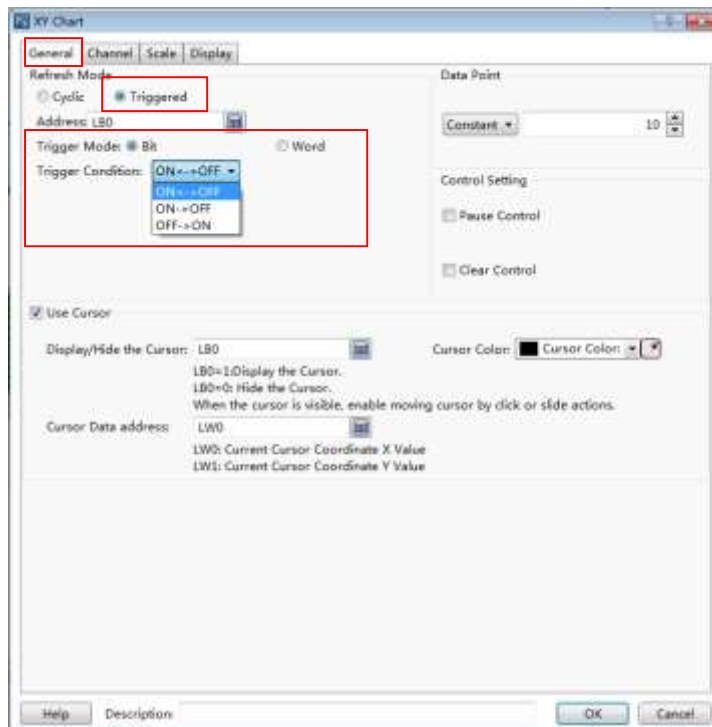

For example, if the trigger condition is set "OFF→ ON", that means the XY curve will be refreshed when the specified bit register is changed from OFF to ON.

There is an option “Auto Reset” for the trigger condition "OFF→ ON" and “ON→OFF”. If you check it, the bit register state will be reset after it is changed.

For the “Word” trigger mode, the details are referred to: [Detailed manual/General functions/Drawing/Logical Control](#).

- **Data Point**

The default value is 10. The range is from 2 to 4096. The option “Data Point” can be set by Constant or by Variable.

- **Control Setting**

- **Pause control**

If you check this option, a bit register needs to be specified to control the Pause function. When the bit register is ON, the XY chart is paused and not be refreshed.

VEDA HCT User Manual

- Clear control

If you check this option, a bit register needs to be specified to control the Clear function. When the bit register is ON, the data of the current XY chart is cleared.

- **Use Cursor**

After this option is checked, some parameters need to be set. The settings are shown as below.

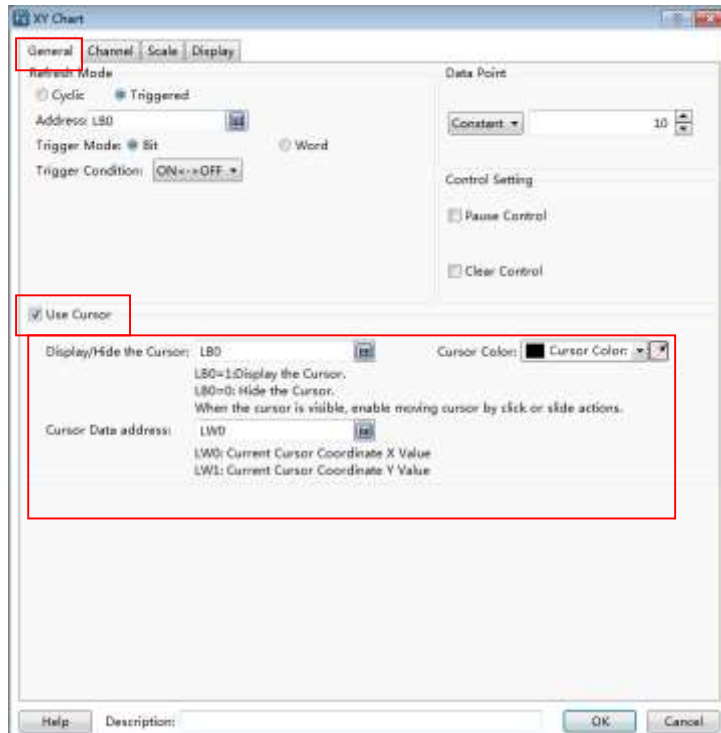

- Display/Hide the cursor

Same to the Trend Curve, a bit register needs to be specified to control the cursor display or hide.

- Cursor Color

The cursor color is set here.

- Cursor Data address

Similarly, you need to set a starting address of a continuous word registers area here to save the coordinate data information of which the cursor is crossed with the XY chart. The data type is depended on the setting in the "Channel" property TAB. For example, the data type is set "16-bit Unsigned in the "Channel" property TAB and the first starting register address is set LW100, then the data of the cursor (X, Y) is (LW100, LW101). If the

VEDA HCT User Manual

data type is "Single-precision Floating-point Number", then the data of the cursor (X, Y) is (LW100, LW102). Other data types can be done in the same matter.

4.6.7.2.2 Channel

The "Channel" property TAB is shown as below.

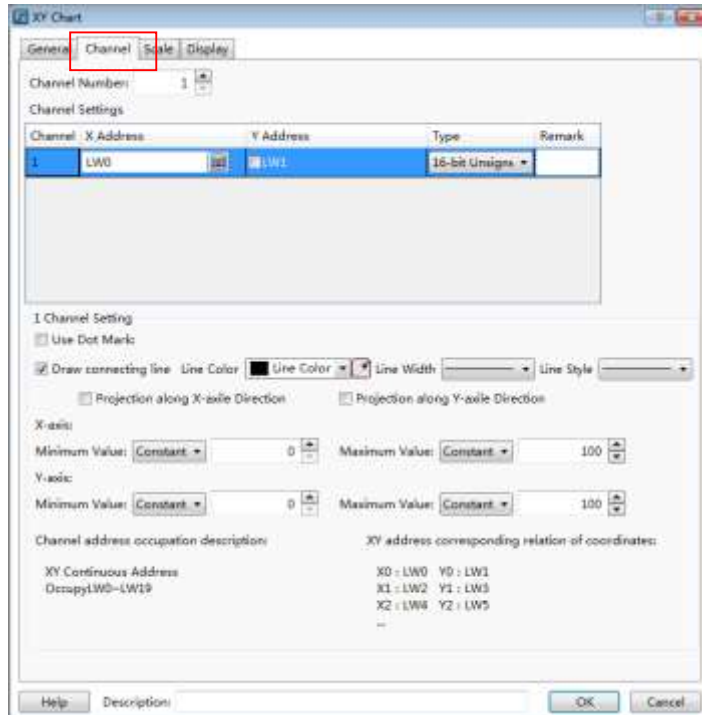

- **Channel Number**

The default value of the "Channel Number" is 1. The XY chart can display up to 16 channels simultaneously.

- **Channel Settings**

You can define the channel information in the "Channel Settings" table: the X address and the Y address are continuous by default. As shown as above, the default starting X address is LW0 and the default starting Y address is LW1. They are continuous. If you check the box in front of the Y address, the Y address can be not continuous with the X address. For example, you can set the starting Y address LW100.

- **Type**

Select the data type for the current channel according to the actual needs.

VEDA HCT User Manual

➤ Remark

You can note the name of the curve for the current channel in the “Remark” column. For example, channel 1 is noted as "Disc A track".

Same as the Trend Curve, select a channel in the “Channel Settings” table, there are many parameters can be set for the selected channel in the following "Channel Setting". The most parameters are same to the settings of the Trend Curve. The option “Projection along Y-axis Direction” is added here. The meaning of this option is same to the "Projection along X-axis Direction" but the direction is different. The Minimum Value and the Maximum Value of the Y-axis can be set different with X-axis. They can be set by Constant or by Variable. The default range of the Minimum Value and the Maximum Values from 0 to 100. The detailed settings can be referred to the "Channel" property TAB of the Trend Curve.

For the information of the occupied addresses by the current channel, it is depended on the data type of this channel. You can view the text which is noted below the “Channel Setting”. It is shown as below.

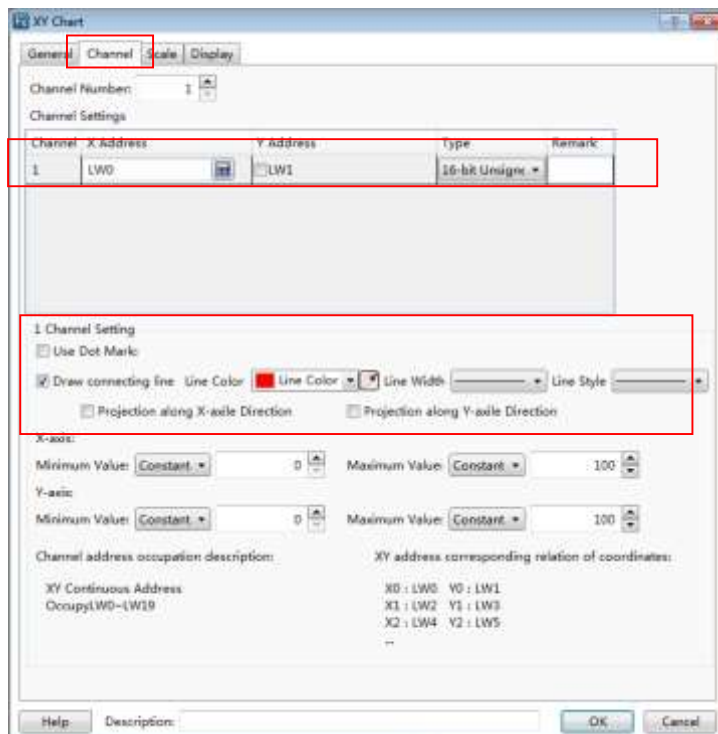

4.6.7.2.3 Scale

Refer to the "Scale" property TAB of Trend Curve.

4.6.7.2.4 Display

The settings of the “Display” property TAB are referred to: [Detailed manual/General functions/Drawing/Display](#).

VEDA HCT User Manual

4.6.7.3 Data Group Chart Display

The “Data Group Chart Display” component is a curve comprising of a set data of specified continuous registers.

4.6.7.3.1 General

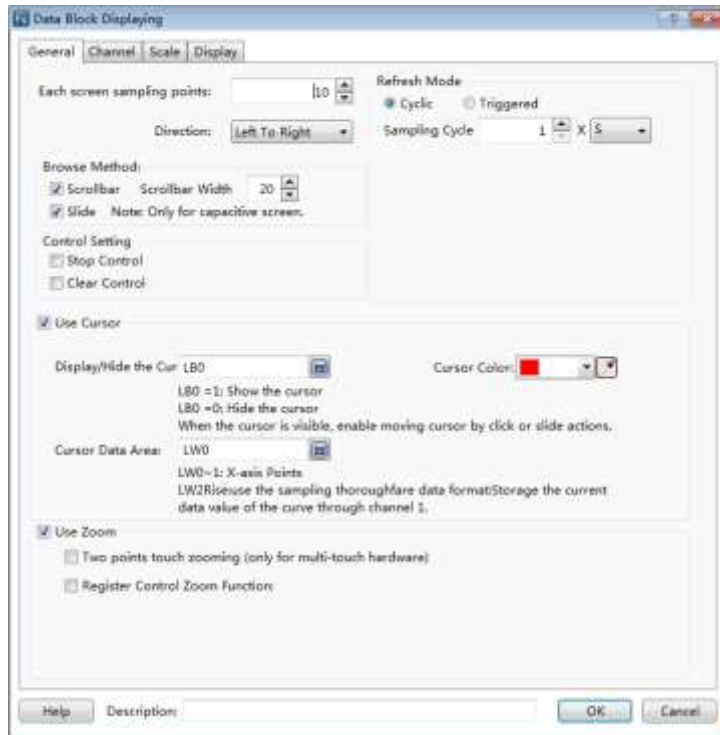

- **Each screen sampling points**

The default value of this option is 10. The minimum value is 2 and the maximum value is less than the width of the used screen resolution. For example, the used screen resolution is 800*480, and then the maximum value of samples per screen is 799.

- **Direction**

The “Direction” option is set "Left To Right" by default. You can set it "Up To Down" too. They are corresponding to the "Horizontal" and "Vertical" display modes.

The settings of these parameters such as the “Browse Method”, the "Control Setting", the "Refresh Mode" and the "Use Zoom" are same to the "XY Chart". The details can be referred to the settings in the “General” property TAB of XY Chart.

- **Use Cursor**

It is not checked by default. After check it, the parameters are shown as below.

VEDA HCT User Manual

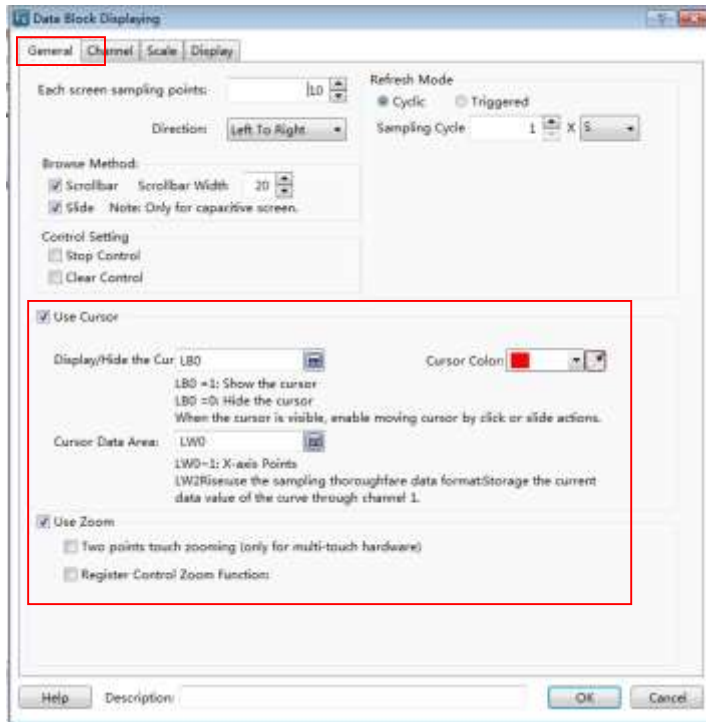

The settings of these options are same to the Trend Curve or the XY Chart, such as the “Display/Hide the Cursor” and the “Cursor Color”.

- **Cursor Data Area**

Similarly, you can set a "Word Register" as the starting address of the continuous registers here. The first two word registers are used to save the point number where the cursor stays. The registers from the specified register address + 2 are used to save the data of which the cursor is crossed with the XY chart.

As shown as above, the starting register is set LW0, and then LW0 and LW1 save the point number where the cursor stays. If there are three channels for the XY chart, the data type of the Channel 1 is "16-bit Unsigned", the second channel is "Single-precision Floating-point Number", the third channel is "32-bit Unsigned", then LW2 (16-bit Unsigned number) save the Channel 1 data, LW3 (Single-precision Floating-point Number) save the Channel 2 data, LW5 (32-bit Unsigned) save the Channel 3 data. Other channels can be done in the same matter.

4.6.7.3.2 Channel

VEDA HCT User Manual

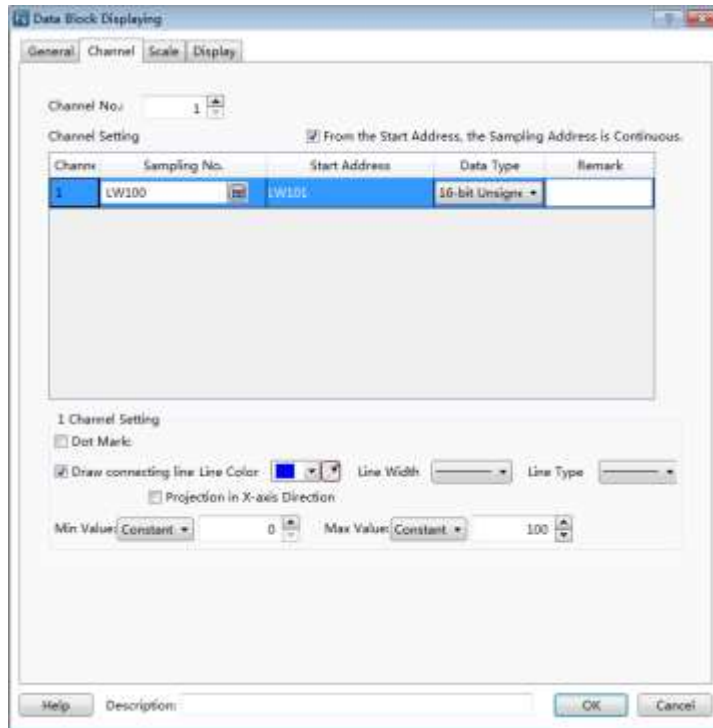

- **Channel No.**

There is 1 channel by default. A “Data Group Chart Display” component can display up to 16 channels.

- **From the Start Address, the Sampling Address is Continuous.**

This option is checked by default. If the register of the “Sampling No.” for channel 1 in the “Channel Setting” table is set "LW100" and the “Data Type” is "16-bit Unsigned", then LW101 is used to save the first sample data, LW102 is used to save the second, and so on. If the “Data Type” is set "32-bit Unsigned", then LW101 (32-bit Unsigned) saves the first sample data, LW103 (32-bit Unsigned) saves the second sample data. Other data types can be done in the same matter.

If you don't check the option "From the Start Address, the Sampling Address is Continuous.", it means the “Start Address” of the registers to save the sample data can be set independently. The settings are shown as below.

VEDA HCT User Manual

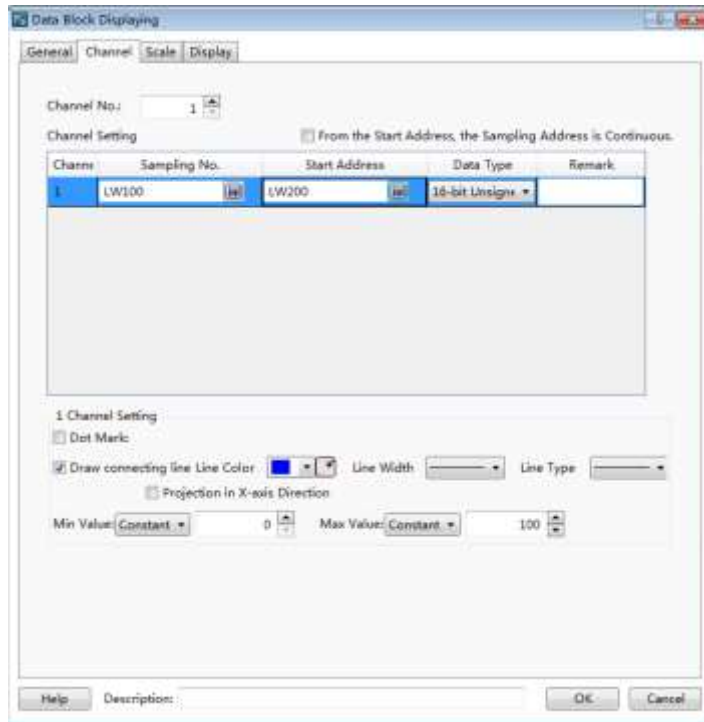

The below parameters setting for the selected channel is same to the Trend Curve or the XY Chart. Please refer to the settings in the “Channel” property TAB of the Trend Graph or XY Curve.

4.6.7.3.3 Scale

Refer to the settings in the “Scale” property TAB of the Trend Curve.

4.6.7.3.4 Display

The settings of the “Display” property TAB are referred to: [Detailed manual/General functions/Drawing/Display](#).

4.6.8 Scale

The "Scale" includes four types: “Horizontal Scale”, “Vertical Scale”, “Arc Scale” and “Round Scale”. You can add a Scale component by clicking the menu command or by using the shortcut tools bar.

VEDA HCT User Manual

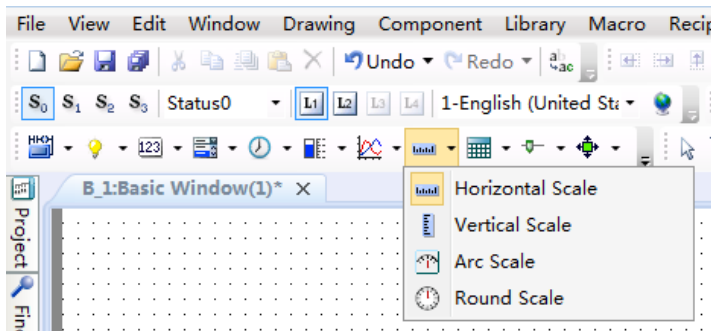
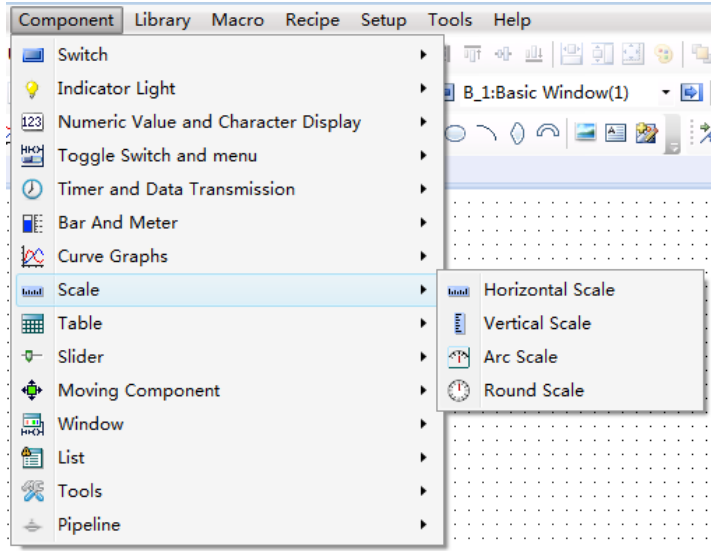

The “Horizontal Scale” is mainly used to display a progress bar. The “Vertical Scale” can be used to display the current liquid level of a tank or the charge state of a battery. The “Arc Scale” can display the value of a fuel meter, a speed meter, and other display devices. The “Round Scale” can display the revolution speed, the angle and other parameters.

4.6.8.1 General

4.6.8.1.1 Horizontal Scale

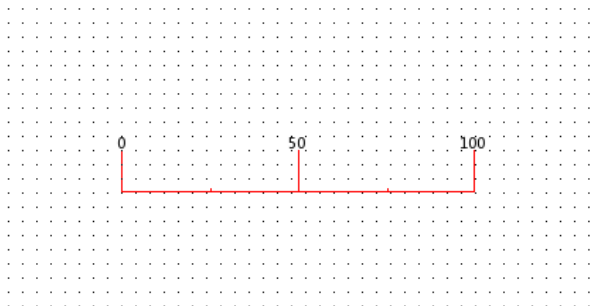

First, the option “Horizontal” is selected. Then you can do other settings for the Horizontal Scale component.

VEDA HCT User Manual

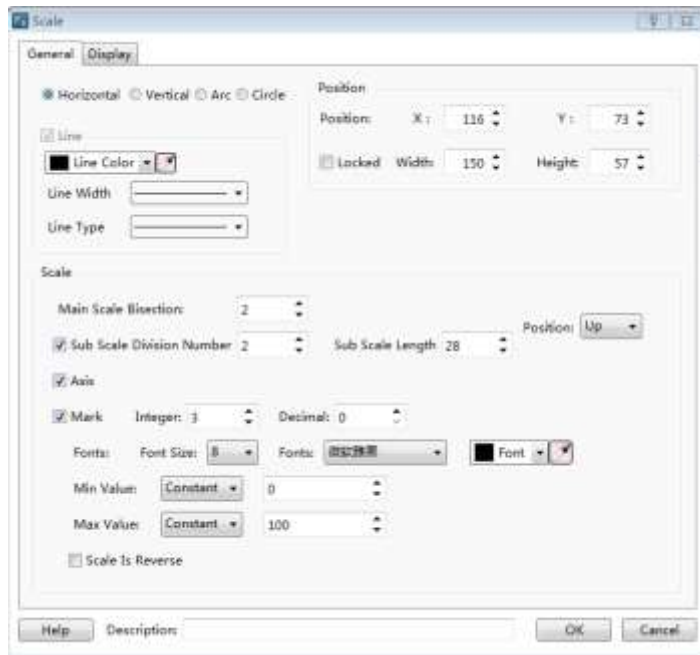

- Line

You can set the line color, the line width and the line type to meet the needs of your project.

- Scale

- Main Scale Bisection

Subdivide the scale in the scale range.



- Sub Scale Division Number

The main scale is subdivided singly. The option “Sub Scale Length” can be set to make difference with the main scale.

VEDA HCT User Manual

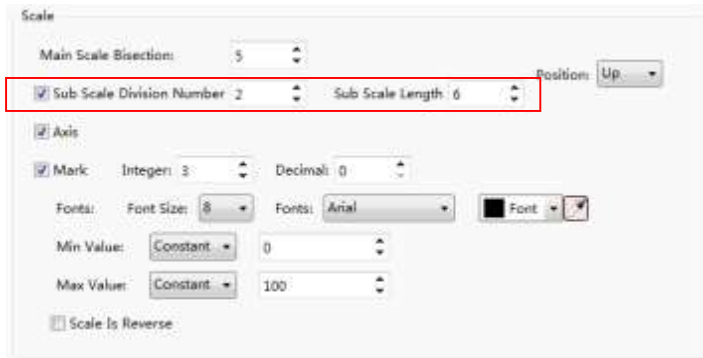

➤ Mark

The option “Mark” is used to set the value of the main scale.

The option “Integer” refers to the number of the decimal integer digits. The option “Decimal” refers to the number of the decimal fraction digits.

You can set the font size, the font color and the font type for the main scale here.

The options “Min Value” and “Max Value” are used to set the range of the main scale.

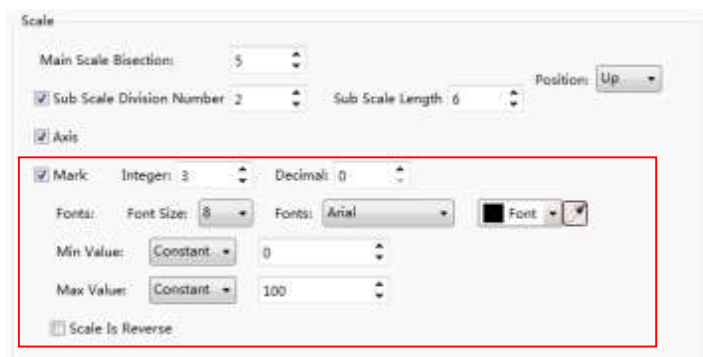

The options “Min Value” and “Max Value” can be set by Constant or by Variable. If you set them by Variable and specify word registers for them, you can change the range of the main scale by modifying the value of the specified word registers.

VEDA HCT User Manual

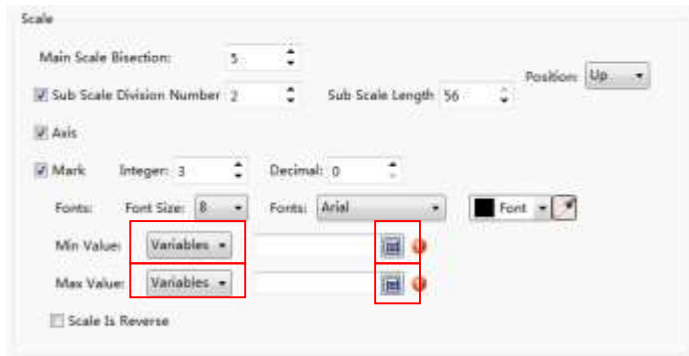

Usually, the scale value is displayed increasing from left to right. Sometimes, it needs to be displayed increasing from right to left. To do that, you should check the option “Scale Is Reverse”.

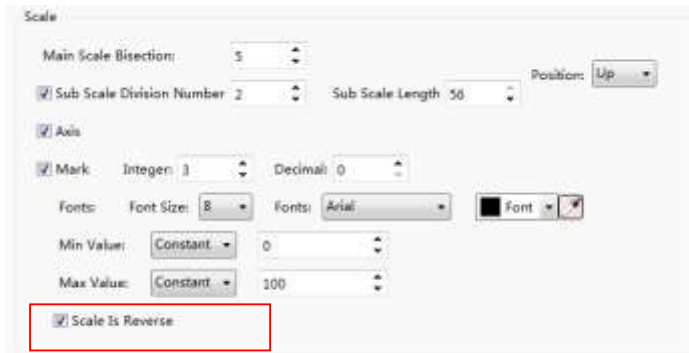

➤ Axis

You can check the option “Axis” to display the axis of the scale. The position of the axis can be set “Up”, “Down” or “Center”. Of course, you can remove the check to hide the axis of the scale.



4.6.8.1.2 Vertical Scale

For the “Vertical Scale”, the only difference with the “Horizontal Scale” is the option “Position” in the “Scale” property box. It is shown as below.

VEDA HCT User Manual

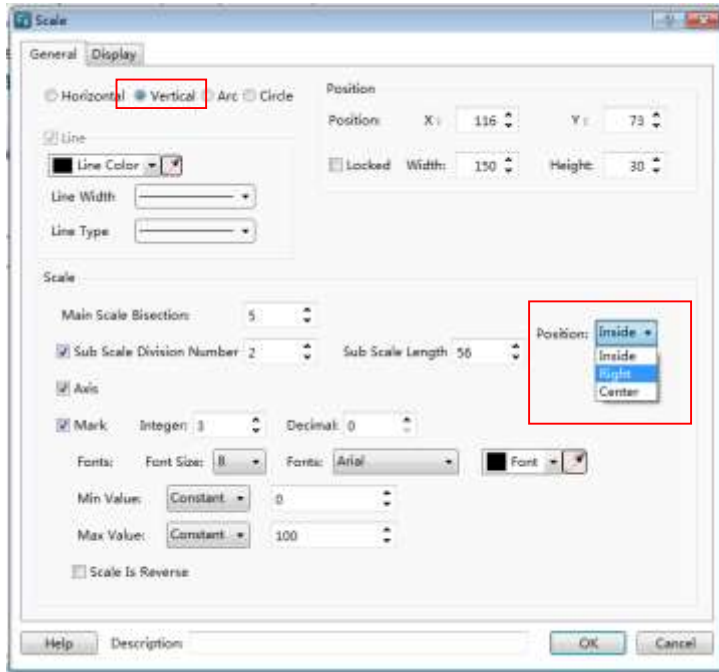

4.6.8.1.3 Arc Scale

For the “Arc Scale”, there are three differences with the “Horizontal Scale”. The options “Starting Angle” and “End Angle” are added in the “Angle” property box. The option “Main Scale Length” is added in the “Scale” property box. The option “Position” in the “Scale” property box is different.

The option “Main Scale Length” is shown as below.

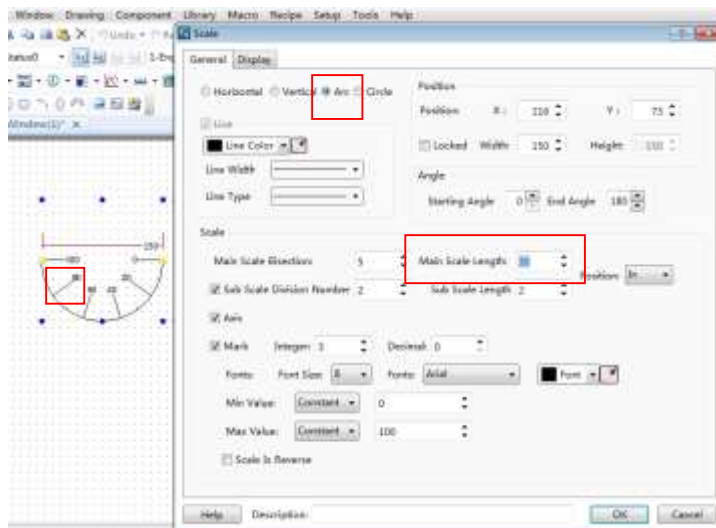

The start angle and the end angle can be set for the arc scale in the “Angle” property box. The settings and the effect are shown as below.

VEDA HCT User Manual

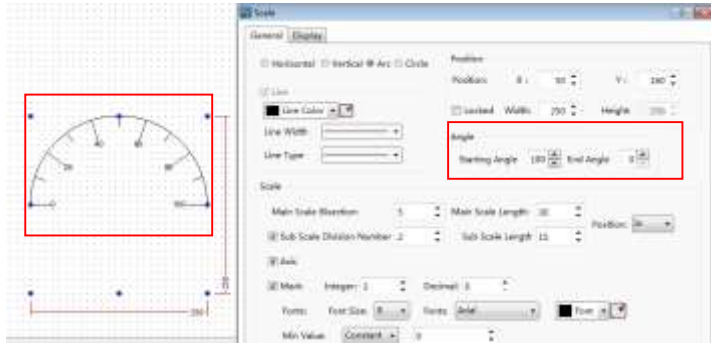

For the option “Position” in the “Scale” property box, the axis position of the scale can set “In”, “Out” and “Center”.

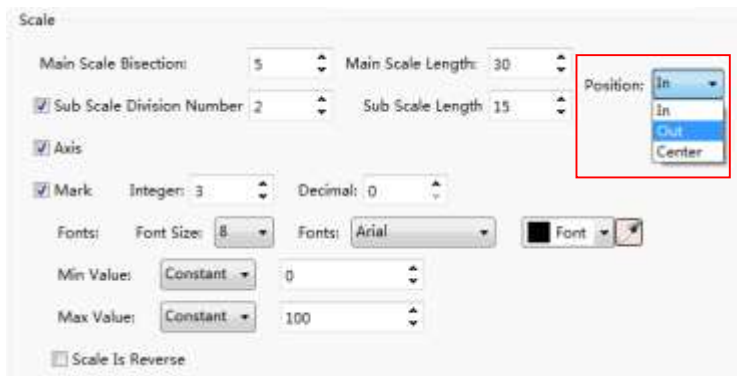

4.6.8.1.4 Round Scale

For the “Round Scale”, the only difference with the “Arc Scale” is that there is not “Angle” settings. It is shown as below.

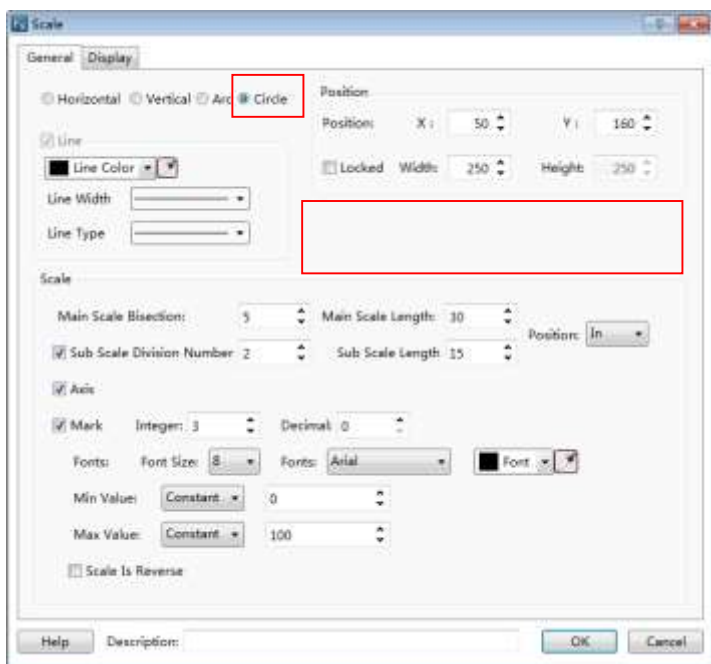

VEDA HCT User Manual

The settings of the “Position” for the Scale component are referred to: [Detailed manual/General functions/Drawing/Position](#).

4.6.8.2 Display

The settings of the “Display” property TAB are referred to: [Detailed manual/General functions/Drawing/Display](#).

4.6.9 Table

The "Table" component is used largely in the project. There are two types: “Fixed-width Table” and “Fixed-height Table”. You can add a Table component by clicking the menu command “Component/Table/Fixed-width Table” or “Component/ Table/ Fixed-height Table”. Of course, you can add it by using the shortcut tools bar.

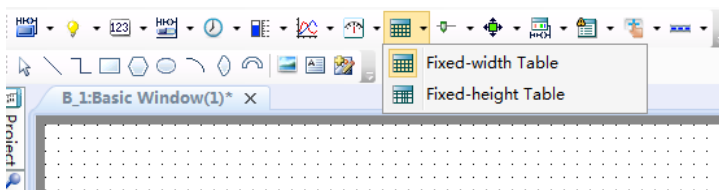
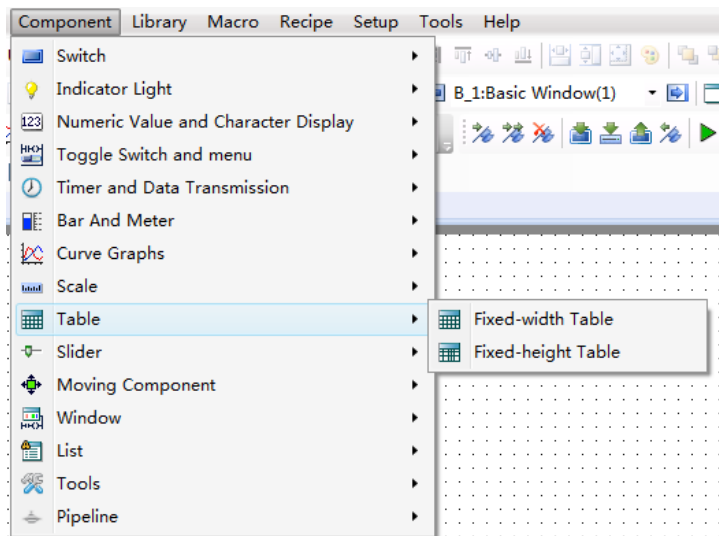

For the fixed-width table, the width of the cells is same and the height of the cells is equal. It is shown as below.

VEDA HCT User Manual

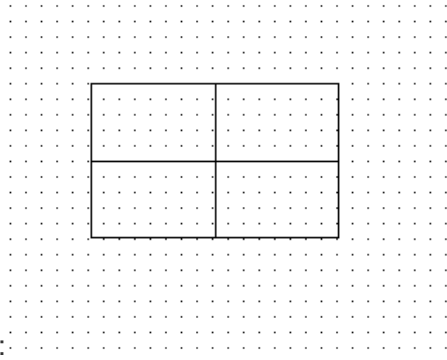

For the fixed-height table, the width and the height of the cells can be modified by mouse-dragging the split line. It is shown as below.

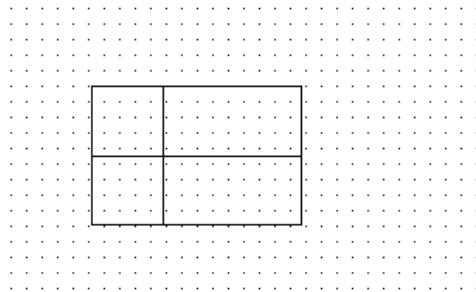

4.6.9.1 General

The “General” property TAB of the “Fixed-width Table” is shown as below.

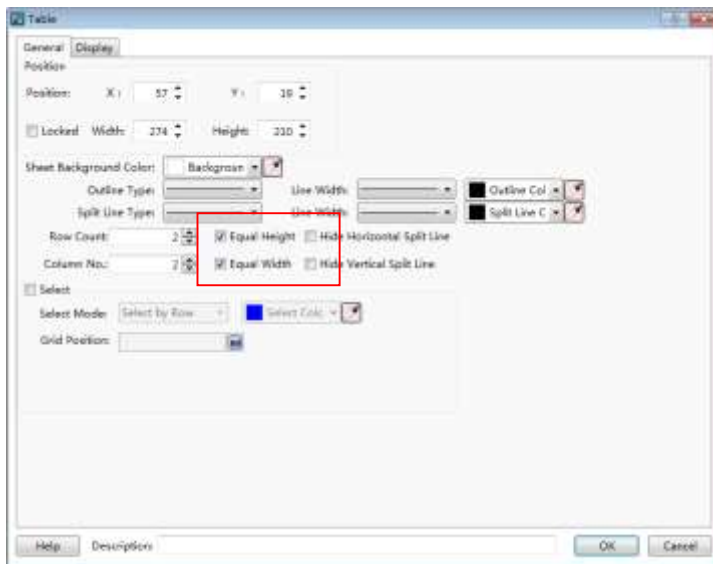

The “General” property TAB of the “Fixed-height Table” is shown as below.

VEDA HCT User Manual

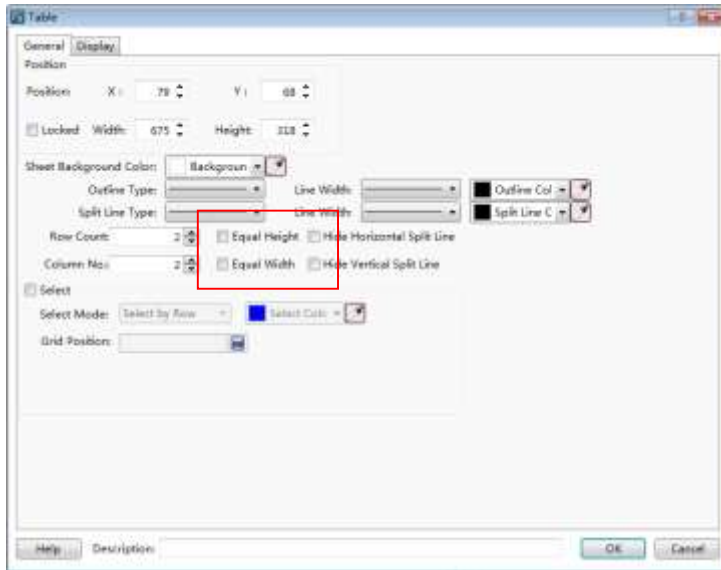

The difference with the “Fixed-width Table” is that the options “Equal Height” and “Equal Width” are not checked. Of course, you can check them and make the Fixed-height Table switch to the Fixed-width Table.

- Position

The option “Position” in the “General” property TAB is referred to: [Detailed manual/General functions/Drawing/Position](#).

- Appearance settings

The background color, the outline color, the split line color, the outline type, the split line type, the outline width and the split line width can be set for the table component appearance according to your needs and the project configuration.



VEDA HCT User Manual

The option “Row Count” and the option “Column No.” are used to set the number of the rows and the columns of the table. The option “Equal Height” and the option “Equal Width” can be checked. If they are all checked, the table will be a fixed-width table.

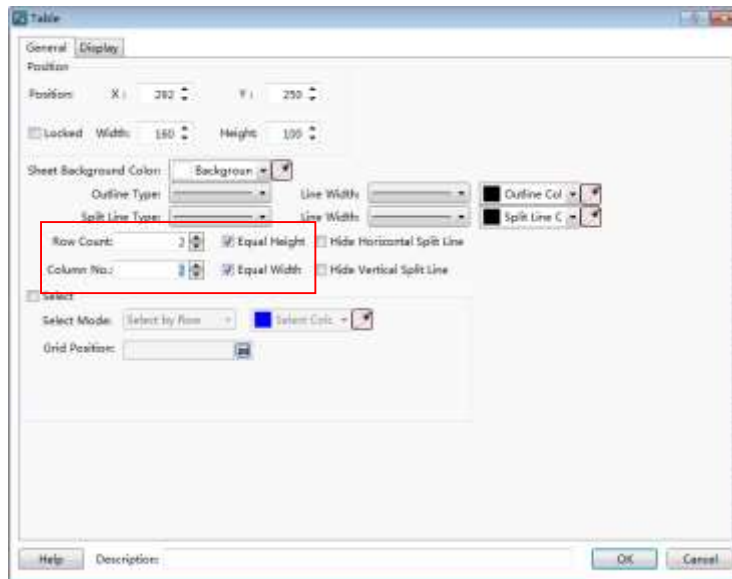

The option “Hide Horizontal Split Line” and the option “Hide Vertical Split Line” can be checked. You can check anyone or two to hide the split line of the table according to your needs

For example, only check the option “Hide Vertical Split Line”. It is shown as below.

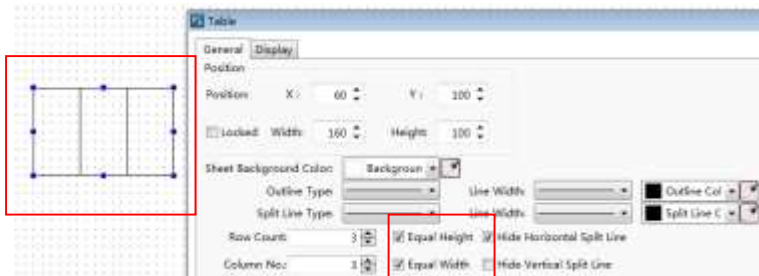

- Select

In the “General” property TAB, if you check the option “Select”, the “Control Settings” property TAB will display.

VEDA HCT User Manual

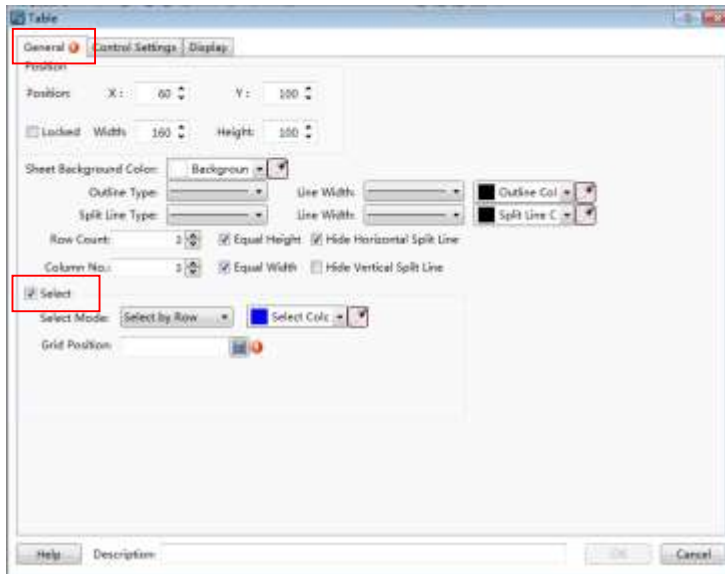

➤ Select Mode and Select Color

After checking the option “Select”, you can set the color of the row/column/cell which is selected during running the project. The option “Select Mode” can be set “Select by Row”, “Select by Column” or “Select by Cell”. It determines that the selected is a row, a column or a cell.

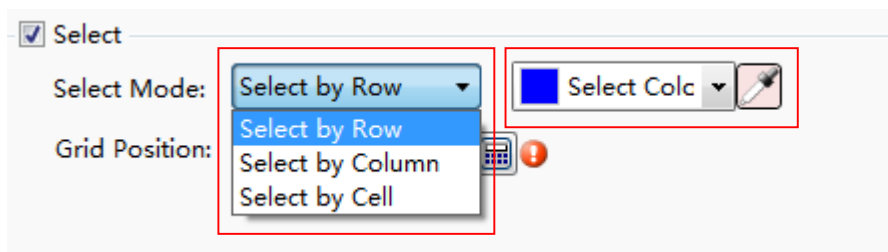

➤ Grid Position

For the option “Grid Position”, you need to give a word register to record the selected row number if the select mode is “Select by Row”. The first row number is 0.

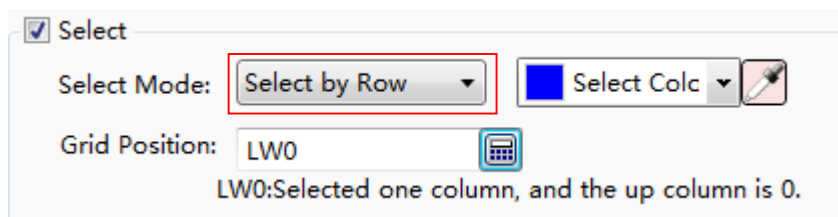

You need to give a word register to record the selected column number if the select mode is “Select by Column”. The first column number is 0.

VEDA HCT User Manual

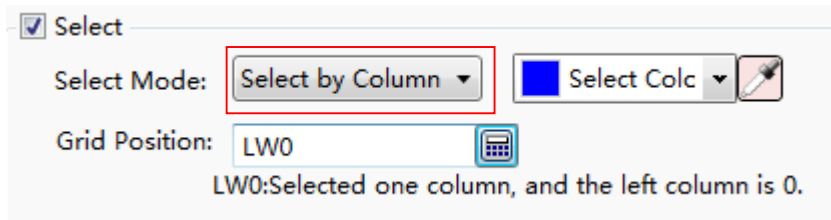

The effect of the "Select by Row" mode is shown as below.

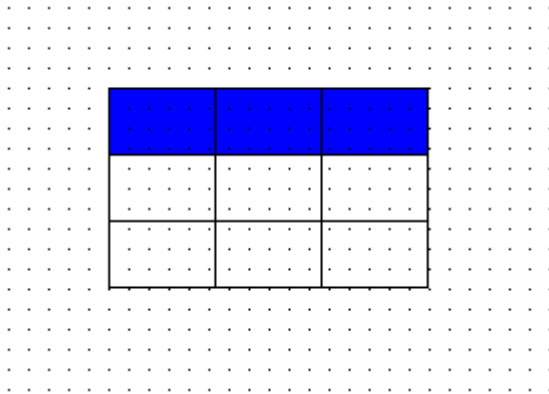

The effect of the "Select by Column" mode is shown as below.

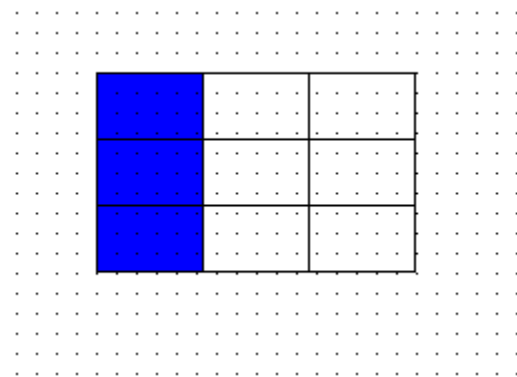

When selecting the mode "Select by Cell", two continuous word registers are occupied. You need to give the first address of the two word registers here. The first word register records the selected row number and the second records the selected column number. The first row number and the first column number are 0.

VEDA HCT User Manual

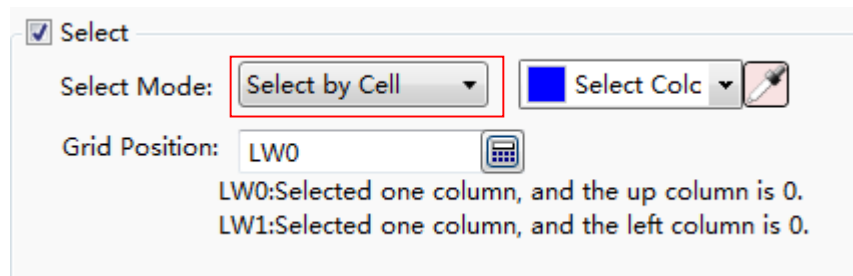

The effect of the “Select by Cell” mode is shown as below.

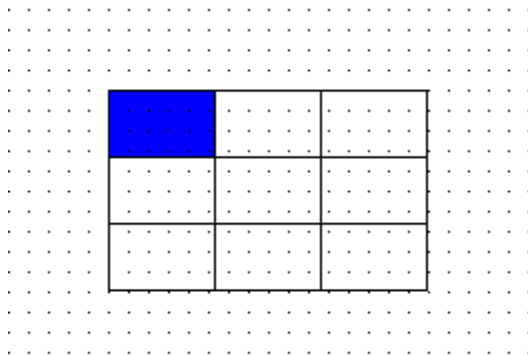

4.6.9.2 Control Settings

The settings of the “Control Settings” property TAB are referred to: [Detailed manual/General functions/Drawing/Control settings](#).

4.6.9.3 Display

The settings of the “Display” property TAB are referred to: [Detailed manual/General functions/Drawing/Display](#).

4.6.10 Slider

The "Slider" component can change the value of the specified word register by pressing and moving the slider block.

4.6.10.1 General

VEDA HCT User Manual

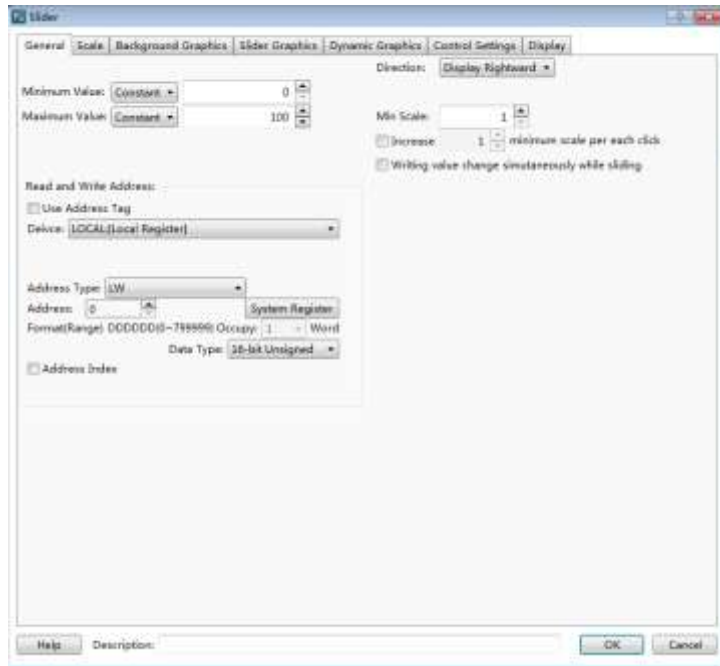

- Minimum Value

The option “Minimum Value” refers to the minimum value of the slider. It can be set by a constant or by a variable. When use a variable to set, the details are referred to: [Detailed manual/General functions/Address editor/Standard Byte Address Input](#).

- Maximum Value

The option “Maximum Value” refers to the maximum value of the slider. It can be set by a constant or by a variable. When use a variable to set, the details are referred to: [Detailed manual/General functions/Address editor/Standard Byte Address Input](#).

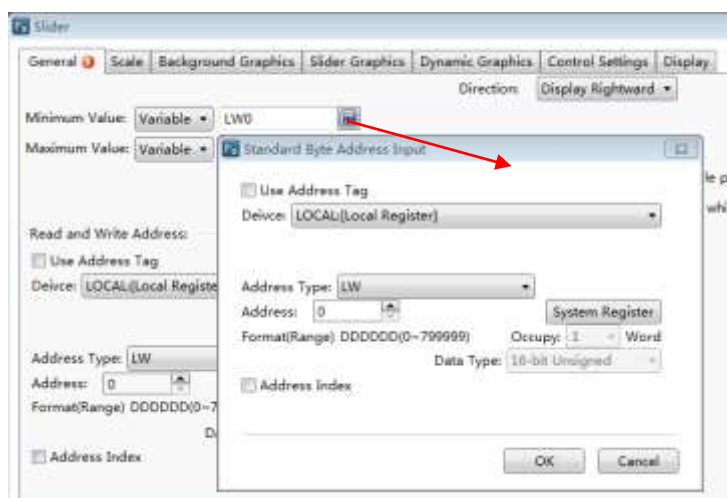

- Read and Write Address

VEDA HCT User Manual

You should specify a word register to change the value for the slider component. The word register input method is referred to: [Detailed manual/General functions/Address editor/Standard Byte Address Input.](#)

- Direction

The option “Direction” is used to set the display direction of the slider. It can be set “Display Upward”, “Display Downward”, “Display Leftward” and “Display Rightward”,.

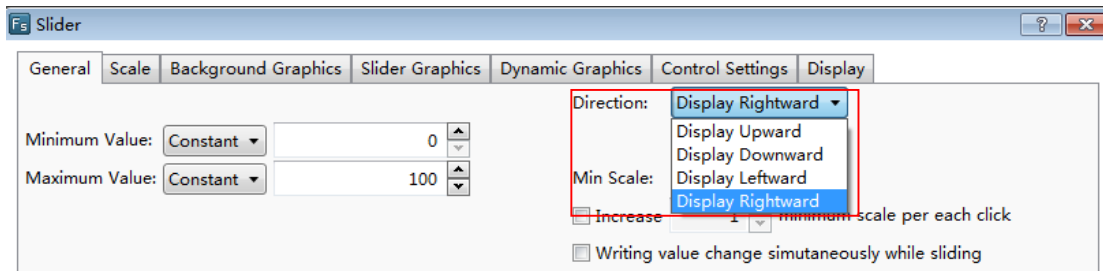

- Min Scale

The “Min Scale” refers to the step of the slider block.

- Increase

The option “Increase” is used to set the minimum increase or decrease per each click. It should set multiple of the “Min Scale”.If this option is not checked, it is set the value of the “Min Scale” by default.

- Writing value change simultaneously while sliding

After this option is checked, the word register which is set in the option “Read and Write Address” will change in real time during sliding the slider component. If it is not checked, the value of the word register will change after the slider block is released.

4.6.10.2 Scale

The settings of the “Scale” property TAB are referred to: [Detailed manual/Component/ Scale.](#)

4.6.10.3 Background Graphics

The settings of the “Background Graphics” property TAB are referred to: [Detailed manual/General functions/Drawing/Graphic edit.](#)

4.6.10.4 Slider Graphics

VEDA HCT User Manual

The settings of the “Slider Graphics” property TAB are referred to: [Detailed manual/General functions/Drawing/Graphic edit.](#)

4.6.10.5 Dynamic Graphics

The settings of the “Dynamic Graphics” property TAB are referred to: [Detailed manual/General functions/Drawing/Dynamic Graphics.](#)

4.6.10.6 Control Settings

The settings of the “Control Settings” property TAB are referred to: [Detailed manual/General functions/Drawing/Control settings.](#)

4.6.10.7 Display

The settings of the “Display” property TAB are referred to: [Detailed manual/General functions/Drawing/Display.](#)

4.6.11 Moving Component

You can click the menu command “Component/Moving Component/Moving Component” to add a moving component in your project.

4.6.11.1 General

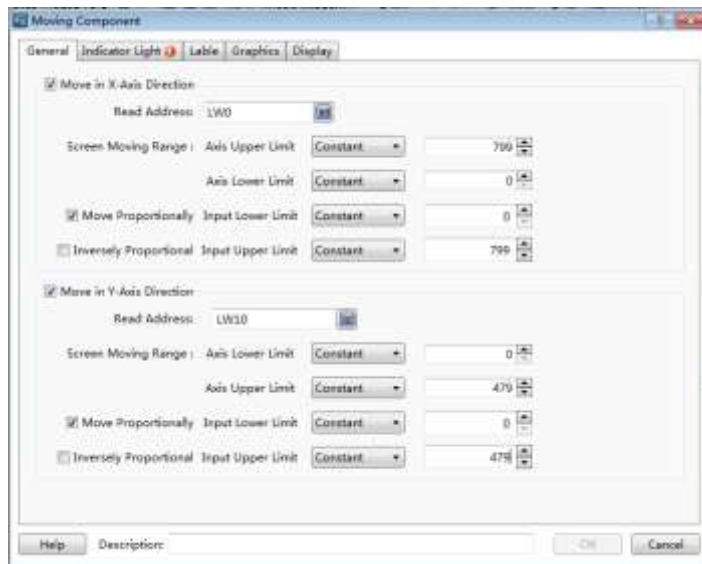

The option “Move in X-Axis Direction” refers to moving along the horizontal direction. The option “Move in Y-Axis Direction” refers to moving along the vertical direction. These two options can be checked together. That means moving in an oblique line direction. The angle of the oblique line can be computed based on the moving distance along the x-axis and along the y-axis.

VEDA HCT User Manual

4.6.11.1.1 Move in X-Axis Direction

- Read Address

For this option, you should set a word register to specify the moving distance of the moving component along the x-axis. The standard word address input method is referred to: [Detailed manual/General functions/Address editor/Standard Byte Address Input](#).

- Screen Moving Range

After check this option, you should set the upper limit and lower limit of the moving range on the screen.

- Axis Lower Limit

The option “Axis Lower Limit” refers to the minimum value of x-axis for the moving range. It can be a constant or a variable. When it is a variable, the details are referred to: [Detailed manual/General functions/Address editor/Standard Byte Address Input](#).

- Axis Upper Limit

The option “Axis Upper Limit” refers to the maximum value of x-axis for the moving range. It can be a constant or a variable. When it is a variable, the details are referred to: [Detailed manual/General functions/Address editor/Standard Byte Address Input](#).

- Move Proportionally

After check this option, the moving component will move according to the proportion that the “Input Lower Limit” is corresponding to the “Axis Lower Limit” and the “Input Upper Limit” is corresponding to the “Axis Upper Limit”.

For example, the “Axis Lower Limit” is 0, the “Axis Upper Limit” is 799, the “Input Lower Limit” is 0, and the “Input Upper Limit” is 7990. When the value of the specified word register is 0, the position is corresponding to the x coordinate: 0. When the value of the specified word register is 7990, it is corresponding to the x coordinate: 799.

- Inversely Proportional

This option can be checked when the option “Move Proportionally” is checked. After it is checked, the “Input Lower Limit” is corresponding to the “Axis Upper Limit” and the “Input Upper Limit” is corresponding to the “Axis Lower Limit”. The moving component will move in a inverse proportion.

4.6.11.1.2 Move in Y-Axis Direction

VEDA HCT User Manual

The settings of the “Move in Y-Axis Direction” are same to the “Move in X-Axis Direction”. But the moving component is along the vertical direction.

4.6.11.2 Indicator Light

Display a picture or a text according to the status of the specified address.

The settings of the “Indicator Light” property TAB are referred to: [Detailed manual/Component/Indicator Light](#).

4.6.11.3 Label

The settings of the “Label” property TAB are referred to: [Detailed manual/General functions/Drawing/Label](#).

4.6.11.4 Graphics

The settings of the “Graphics” property TAB are referred to: [Detailed manual/General functions/Drawing/Graphic edit](#).

4.6.11.5 Display

The settings of the “Display” property TAB are referred to: [Detailed manual/General functions/Drawing/Display](#).

4.6.12 Window

4.6.12.1 Bit Control Window

You can click the menu command “Component/Window/Bit Control Window” to add a bit control window component in your project.

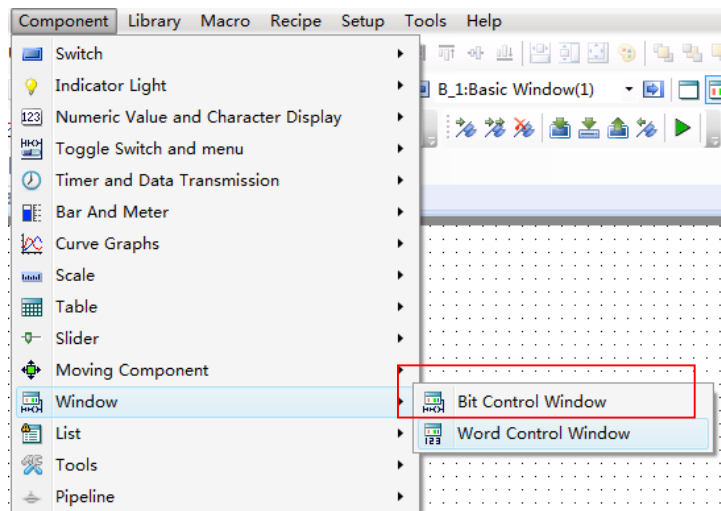

VEDA HCT User Manual

4.6.12.1.1 General

The “Bit Control Window” component is similar to the “Word Control Window” component. The differences with the “Word Control Window” component are pointed out as below. The other details are referred to: [Detailed manual/Component/Window/Word Control Window](#).

- Bit register triggers the pop-up of window

The option “Trigger Bit” is used to specify a bit register to trigger a popup window. The popup window is determined by the option “Popup Window ID No.”. If you select the option “Popup On”, the window will popup when the bit register is ON. If you select the option “Popup Off”, the window will popup when the bit register is OFF.

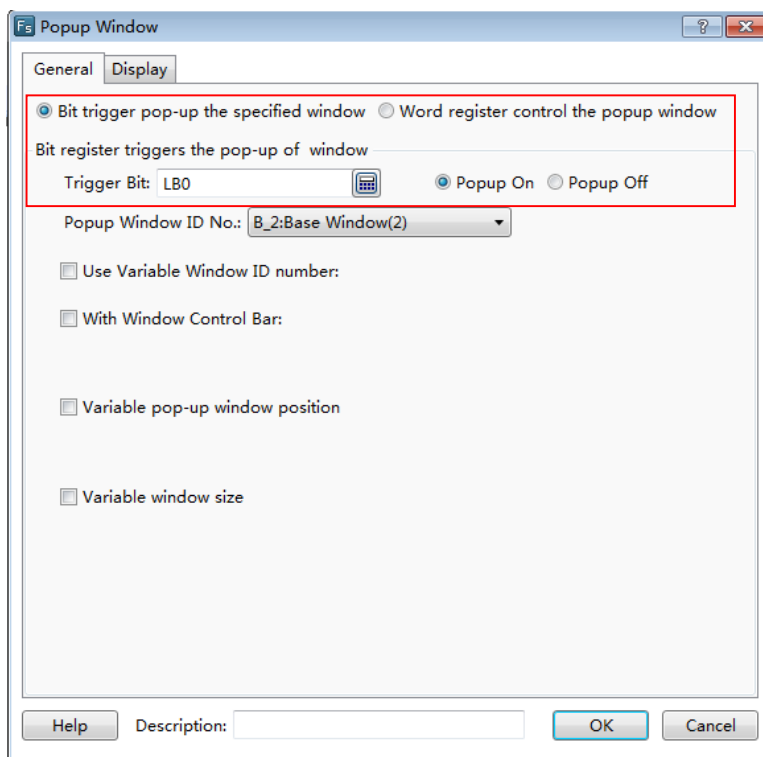

For example, a button named “Popup the window” is connected with LB0 and the trigger bit of the popup window component is set LB0. The simulation running result is shown as below. When press the button “Popup the window”, the specified window will pop up.

VEDA HCT User Manual

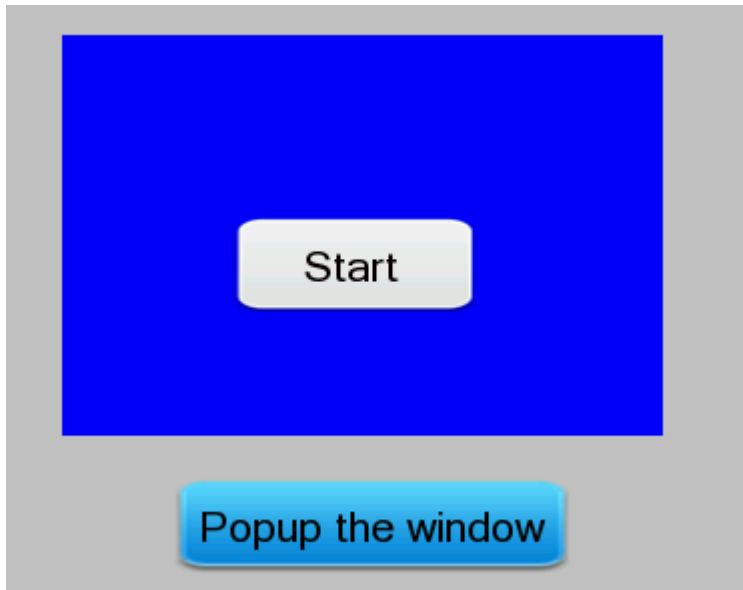

- Use Variable Window ID number

The function of “Use Variable Window ID number” is used to dynamically specify a pop-up window by using a word register.

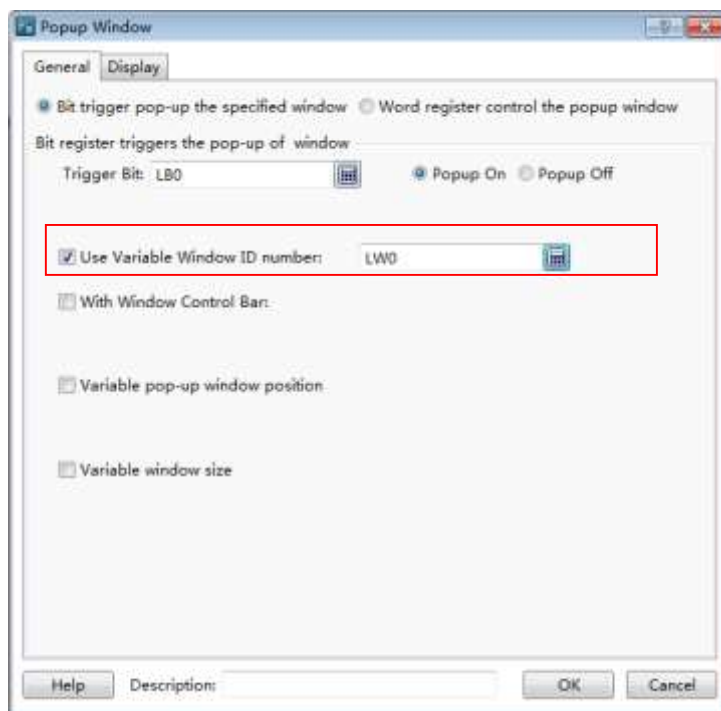

For the above example, the word register is specified LW0 and a numeric value input component is connected with LW0. The simulation running result is shown as below. Enter the corresponding window ID number in the numeric value input component and then click the button “Popup the window”, the designated window will pop up.

VEDA HCT User Manual

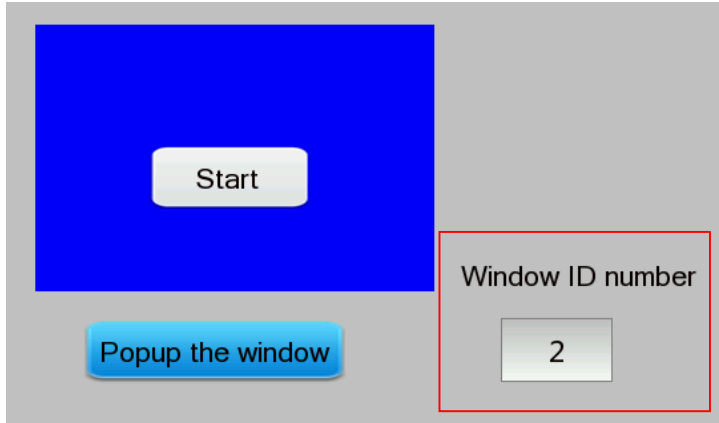

4.6.12.1.2 Display

The settings of the “Display” property TAB are referred to: [Detailed manual/General functions/Drawing/Display](#).

4.6.12.2 Word Control Window

You can click the menu command “Component/Window/Word Control Window” to add a word control window component in your project.

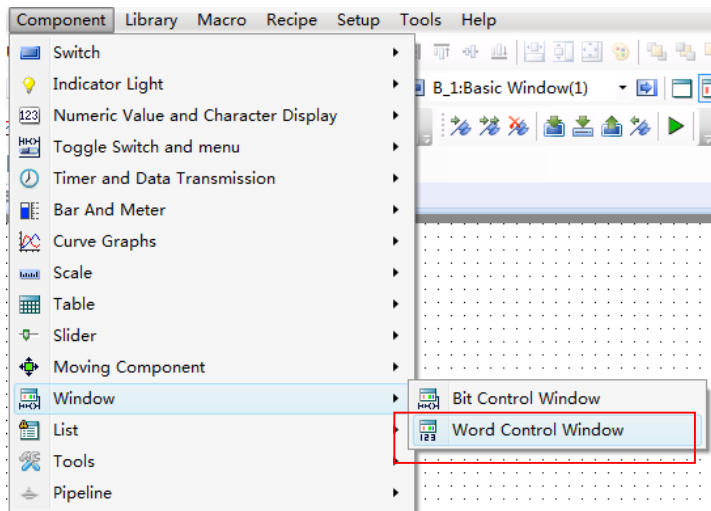

4.6.12.2.1 General

VEDA HCT User Manual

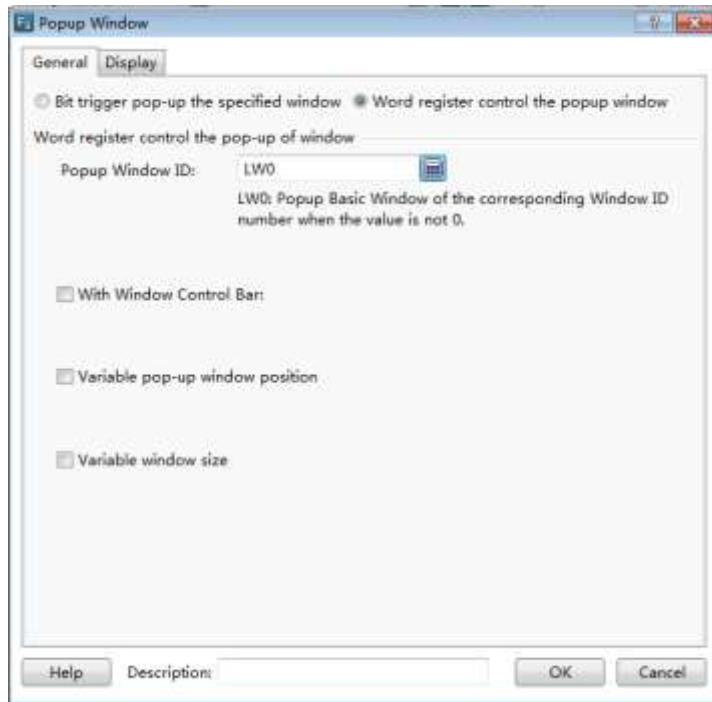

- Word register control the pop-up window

For the option “Popup Window ID”, a word register needs to be given to specify the ID number of the popup window.

For example, add a word control window component and a numeric value input component in your project. The word register controlling the pop-up window is set LW0 and it is also connected with the numeric value input component. It is shown as below.

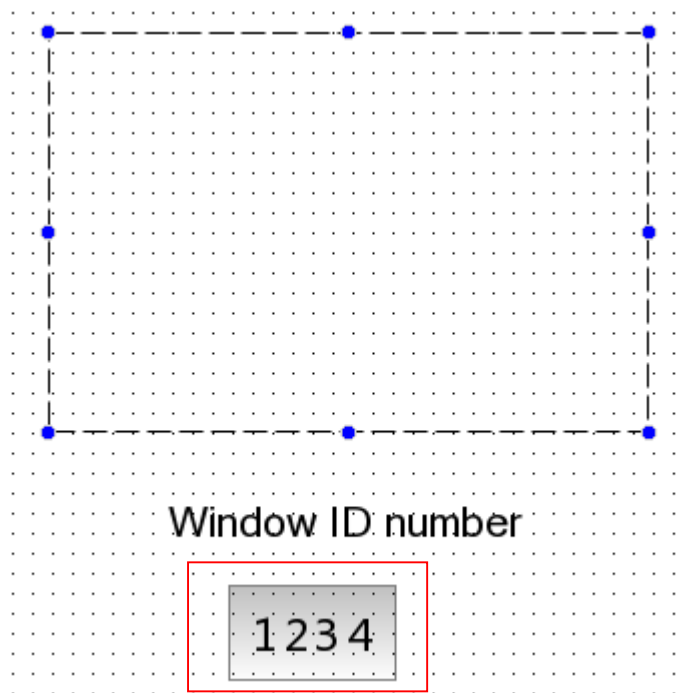

VEDA HCT User Manual

The simulation running result is shown as below. When input a positive integer value to the numeric value input component, the window which the ID number of it is equal to the inputted value will pop up.



- With Window Control Bar

After checking the option “With Window Control Bar”, you can add the window title by checking the option “Title” and add the window close button by checking the option “Close Button”. The font of the window title can be set by clicking the button “Set Title”. The details are referred to: [Detailed manual/General functions/Drawing/Font settings](#).

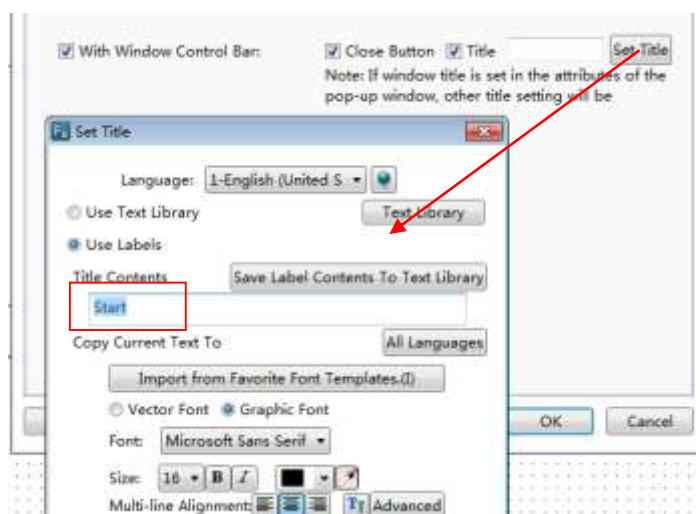

VEDA HCT User Manual

After set the window control bar, the simulation running result is shown as below.

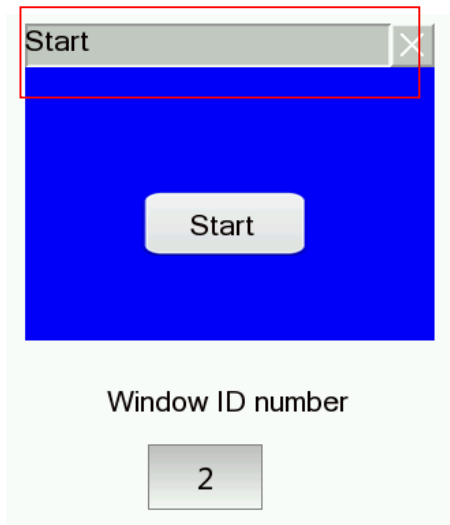

- Variable pop-up window position

After check the option "Variable pop-up window position", a first address of continuous two word registers needs to be given to specify the X and Y coordinates of the pop-up window.



For the above example, check the option "Variable pop-up window position" and the first word register address of the window position control is set LW2. Then add two numeric value input components in your project for inputting the X and Y coordinates of the pop-up window. They are connected with LW2 and LW3 separately.

The simulation running result is shown as below. When change the values of the numeric value input components, the position of the popup window will change.

VEDA HCT User Manual

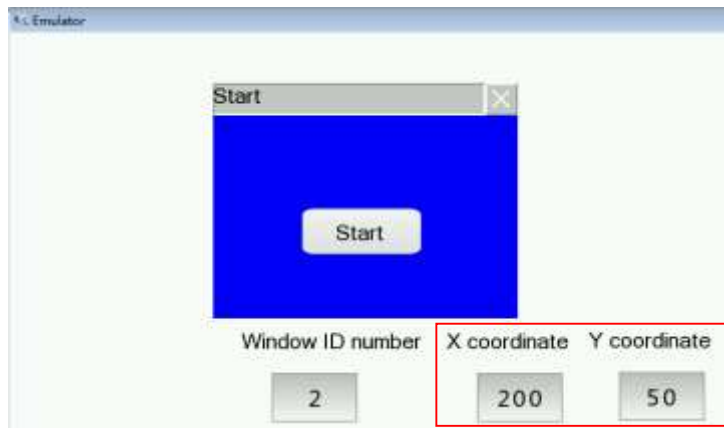
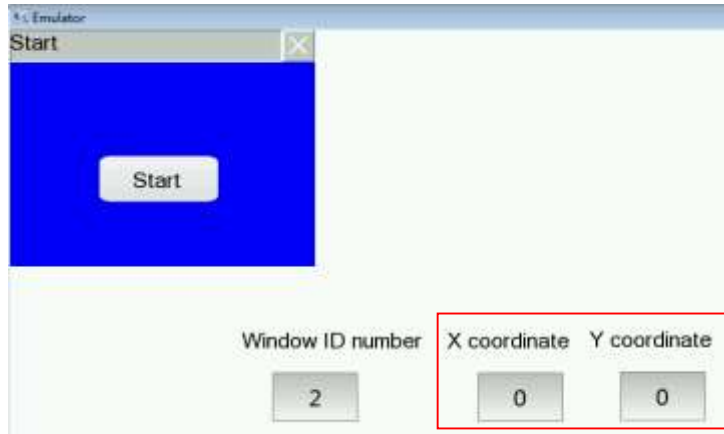

- Variable window size

If you check the option "Variable window size", a first address of continuous two word registers needs to be given to specify the width and height of the popup window.



For the above example, check the option "Variable window size" and the first word register address of the window size control is set LW4. Then add two numeric value input components in your project for inputting the width and height of the pop-up window. They are connected with LW4 and LW5 separately.

The simulation running result is shown as below. When change the values of the numeric value input components, the size of the popup window will change.

VEDA HCT User Manual

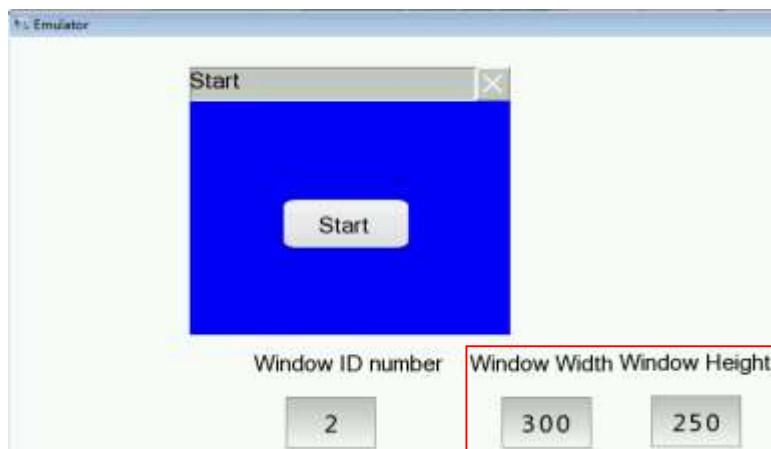
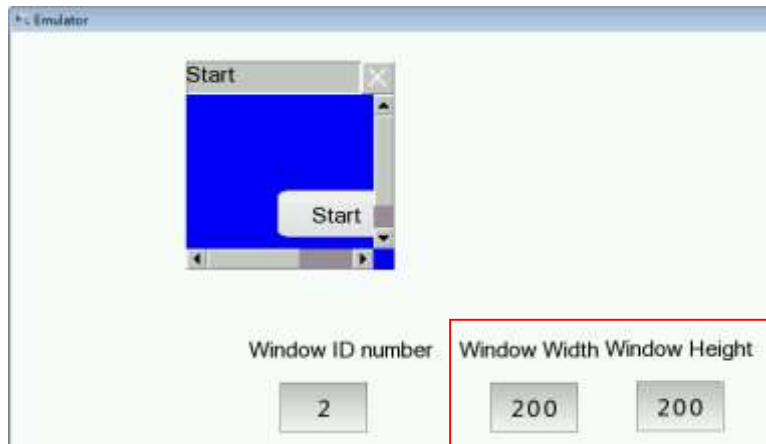

4.6.12.2.2 Display

The settings of the "Display" property TAB are referred to: [Detailed manual/General functions/Drawing/Display](#).

4.6.13 List

4.6.13.1 Alarm and Event Display

4.6.13.1.1 Current Alarm and Event

The "Current Alarm and Event" function is to display the current triggered alarms and events in a tabular form. Only the trigger state is displayed.

- General

The general properties of the "Current Alarm and Event" are basically the same to the "Alarming and Event History". Please refer to: [Detailed manual/Component/List/Alarm and Event History](#).

VEDA HCT User Manual

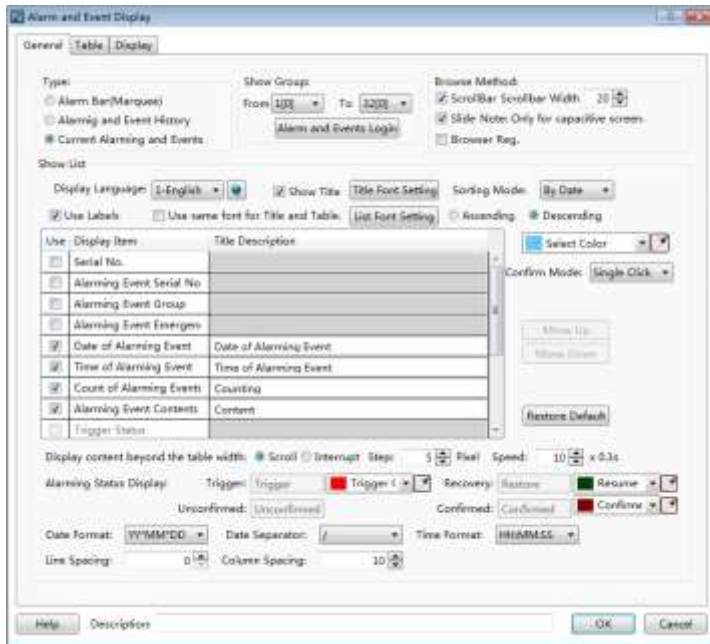

Note:

The differences with the "Alarming and Event History" are shown as below.

Use	Display Item	Title Description
<input checked="" type="checkbox"/>	Count of Alarming Events	Counting
<input checked="" type="checkbox"/>	Alarming Event Contents	Content
<input type="checkbox"/>	Trigger Status	
<input type="checkbox"/>	Confirm Status	
<input type="checkbox"/>	Restore Date	
<input type="checkbox"/>	Restore Time	
<input type="checkbox"/>	Confirm Date	
<input type="checkbox"/>	Confirm Time	

- The "Current Alarm and Event" includes "Count of Alarming Events". But the "Alarming and Event History" does not include it.
- The "Current Alarm and Event" only displays the trigger status. It does not confirm and restore the status. So the gray color options in the table can not be checked.

- **Table**

The settings of "Table" property TAB is referred to: [Detailed manual/General functions/Drawing/Table drawing](#).

- **Display**

The settings of "Display" property TAB is referred to: [Detailed manual/General functions/Drawing/Display](#).

VEDA HCT User Manual

4.6.13.1.2 Alarming and Event History

The “Alarming and Event History” function is to display all alarms entries in tabular form, including the current and historical alarms and events.

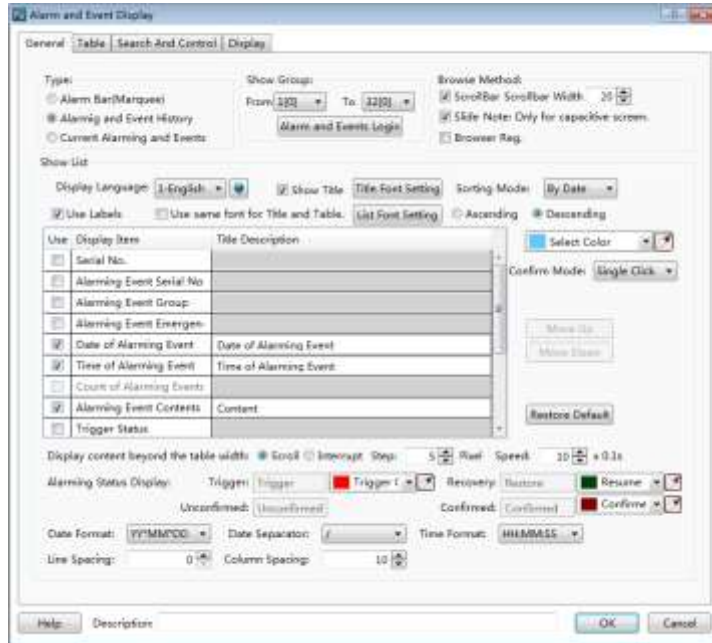

- General
 - Show Group

You can select some groups of alarms and events to display in the alarm list.

Note:

The alarms and events can be grouped when they are created. The range of groups is from 1 to 32. The alarm and event content can be set by clicking the button “Alarm and Events Login” or by double-clicking the “System Settings/Alarm and Event” in the project tree. The details are referred to: [Detailed manual/Setup/System Settings/Alarm and Event](#).

- Browse Method

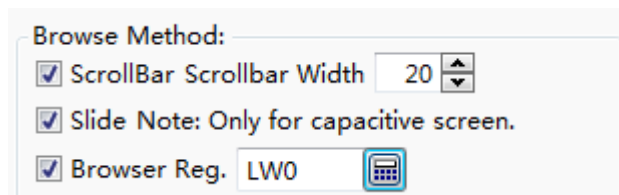

There are three browse methods: “Scroll Bar”, “Slide” and “Browser”.

VEDA HCT User Manual

The scroll bar will display in the alarm list if you check the option “Scroll Bar”. You can view the alarms by using the scroll bar. The “Scrollbar Width” needs to be set. The unit of it is pixel.

You can check the option “Slide” in order to view the alarms by sliding the screen. This function is supported by the capacitive screen devices.

The option “Browser” can be checked when you need to view multiple pages. A word register needs to be specified to define the current page. The default is that 0 represents the records on the current day, 1 represents the records on yesterday, 2 represents the records on the day before yesterday, and so on. The word register input is referred to: [Detailed manual/General functions/Address editor/Standard Byer Address Input](#).

➤ Show List

The screenshot shows the 'Show List' configuration window. It includes the following elements:

- Display Language:** A dropdown menu set to 'English'.
- Show Title:** A checked checkbox.
- Title Font Setting:** A button to open font settings.
- Sorting Mode:** A dropdown menu set to 'By Date'.
- Use Labels:** A checked checkbox.
- Use same font for Title and Table:** An unchecked checkbox.
- List font Setting:** A button to open font settings.
- Ascending/Descending:** Radio buttons, with 'Descending' selected.
- Table:** A table with columns 'Use' and 'Title Description'.

Use	Title Description
<input type="checkbox"/>	Serial No.
<input type="checkbox"/>	Alarming Event Serial No.
<input type="checkbox"/>	Alarming Event Group
<input type="checkbox"/>	Alarming Event Emergen
<input checked="" type="checkbox"/>	Date of Alarming Event
<input checked="" type="checkbox"/>	Time of Alarming Event
<input type="checkbox"/>	Count of Alarming Event
<input checked="" type="checkbox"/>	Alarming Event Contents
<input type="checkbox"/>	Trigger Status
- Select Color:** A dropdown menu.
- Confirm Mode:** A dropdown menu set to 'Single Click'.
- Buttons:** 'Move Up', 'Move Down', and 'Restore Default'.
- Display content beyond the table width:** Radio buttons for 'Scroll' (selected) and 'Interrupt'.
- Steps:** A numeric input set to 5.
- Font Speed:** A numeric input set to 10.
- Alarming Status Display:** A section with 'Trigger' (Trigger 1), 'Recovery' (Restore), and 'Unconfirmed' (Unconfirmed) options.
- Date Format:** A dropdown menu set to 'YYMMDD'.
- Date Separator:** A dropdown menu set to '/'.
- Time Format:** A dropdown menu set to 'HHMMSS'.
- Line Spacing:** A numeric input set to 0.
- Column Spacing:** A numeric input set to 10.

“Display Language”

The “Display Language” is selected to switch the current display language for editing the Title Description. The details are referred to: [Detailed manual/Setup/System Settings/Language Settings](#).

“Show Title”

The option “Show Title” is checked by default. If you do not want to display the title bar, you can cancel the check.

“Title Font Setting”

It is used to set the font of the title bar. The details are referred to: [Detailed manual/General functions/Drawing/Font settings](#).

“Sorting Mode”

VEDA HCT User Manual

The “Sorting Mode” set the arrangement order of the alarms and events.

If you set “By Date” and select the option “Descending”, the latest event will be displayed on the top.

If you set “By Level” and select the option “Descending”, the higher level events are displayed on the top.

If you select the option “Ascending”, the display order is inverse.

“Select Color”

The selected alarm entry will display in the color which is set by the option “Select Color”.

“Confirm Mode”

When the alarm is triggered, it is in the trigger status. If you want to confirm this alarm, you need to select the “Confirm Mode”. It can be “Single Click”, “Double Click” or “Press And Hold”.

“List settings”

The title bar contents of the alarm list are set in the below table. The contents of the title bar can be set to display by checking it. But the gray Display Items can not be checked.

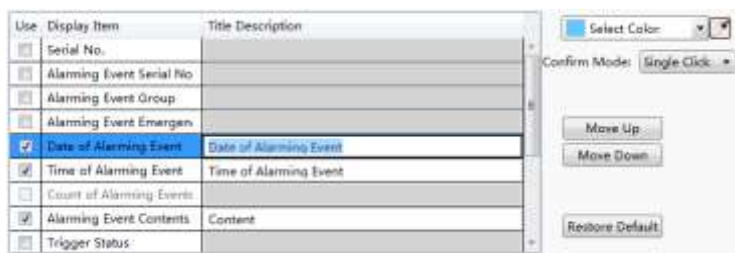

For the order of the contents arrangement, you can use the button "Move Up" or "Move Down" to modify it. The content on the top row will display on the left of the alarm list. You can restore the default arrangement by clicking the button "Restore Default".

“Display content beyond the table width”

There are two modes, “Scroll” and “Interrupt”, to display the title contents when they are more than the alarm list width. You can select one mode to display.

VEDA HCT User Manual

The content will be displayed by scrolling if you select the “Scroll” mode. You need to set the step size (Step: 1 to 255 pixels), and the scrolling speed (Speed: 1 to 255*0.1s).

Display content beyond the table width: Scroll Interrupt Step: Pixel Speed: x 0.1s

The excess contents will be truncated directly if you select the “Interrupt” mode.

“Alarming Status Display”

You can set the text color of the alarms and events in the different status here.

Alarming Status Display: Trigger: Trigger (Recovery: Resume Unconfirmed: Confirmed: Confirmed

“Date and Time Format”

The “Date Format” is used to set the sort order of year (YY), month (MM) and day (DD). The “Date Separator” is used to set the separator among year, month and day. The “Time Format” is used to set the time display format.

“Line Spacing and Column Spacing”

The “Line Spacing” and the “Column Spacing” are to set the ranks spacing of the alarm list. The unit is pixel and the range is 0-255.

- Table

The settings of the “Table” property page TAB are referred to: [Detailed manual/General functions/ Drawing/ Table Drawing](#).

- Search And Control

The “Search And Control” property TAB is shown as below.

VEDA HCT User Manual

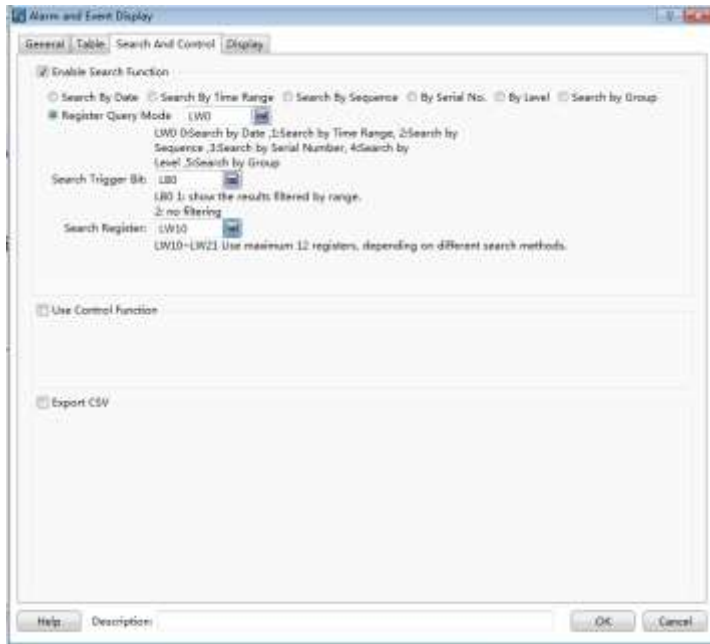

➤ Enable Search Function

Check the option "Enable Search Function" to use the search function.

“Search mode”



There are seven search modes: “Search By Date”, “Search By Time Range”, “Search By Sequence”, “By Serial No.”, “By Level”, “Search by Group” and “Register Query Mode”.

The “Register Query Mode” is a dynamic search mode. You can specify a word register to dynamically adjust the search mode. If the word register is 0, the “Search By Date” mode is used. If it is 1, the “Search By Time Range” mode is used. If it is 2, the “Search By Sequence” mode is used. If it is 3, the “By Serial No.” mode is used. If it is 4, the “By Level.” mode is used. If it is 5, the “Search by Group.” mode is used. The word register address input method is referred to: [Detailed manual/General functions/Address editor/Standard ByteAddress Input.](#)

“Search Trigger Bit”

The option “Search Trigger Bit” is used to specify a bit register to trigger the search function. Note that the search function is not edge-triggered mode. When setting the trigger bit 1, the alarm list displays the filtered results. After set the trigger bit 0, the list

VEDA HCT User Manual

will display the results which are not filtered. The bit address input method is referred to: [Detailed manual/General functions/Address editor/Standard Bit Address Input](#).

“Search Register”

The “Search Register” is used to specify the first word register address for the search function. The number of the word registers is depending on the search mode. The function of the word registers used to search is different for the different search mode. You can get the information of the used word registers according to the text displayed under the first word register address. The word address input method is referred to: [Detailed manual/General functions/Address editor/Standard ByteAddress Input](#).

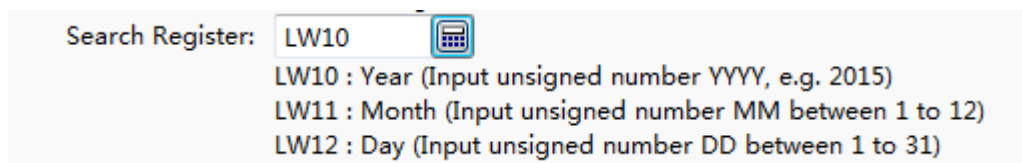

Search Register: LW10 
LW10 : Year (Input unsigned number YYYY, e.g. 2015)
LW11 : Month (Input unsigned number MM between 1 to 12)
LW12 : Day (Input unsigned number DD between 1 to 31)

➤ Use Control Function

After checking this option, you can use word address registers to control the display of the alarms and events in the alarm list.

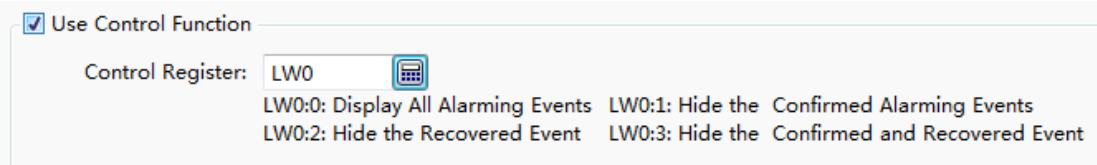

Use Control Function
Control Register: LW0 
LW0:0: Display All Alarming Events LW0:1: Hide the Confirmed Alarming Events
LW0:2: Hide the Recovered Event LW0:3: Hide the Confirmed and Recovered Event

➤ Export CSV

The option “Export CSV” is referred to: [Detailed manual/ General functions/ Drawing/ Export CSV](#).

● Display

The settings of the “Display” property TAB are referred to: [Detailed manual/General functions/Drawing/Display](#).

4.6.13.1.3 Alarm Bar (Marquee)

The “Alarm Bar” function is to display the alarms and events in a single line and in a marquee form. The scrolling direction, step and speed need to be set. A title can be chosen to display.

VEDA HCT User Manual



- General
 - Show Group

The specified groups of the alarms and events will display in the Alarm Bar.

The alarms and events can be grouped when they are created. The range of groups is from 1 to 32. The alarm and event content can be set by clicking the button “Alarm and Events Login” or by double-clicking the “System Settings/Alarm and Event” in the project tree. The details are referred to: [Detailed manual/Setup/System Settings/Alarm and Event](#).

- Show List

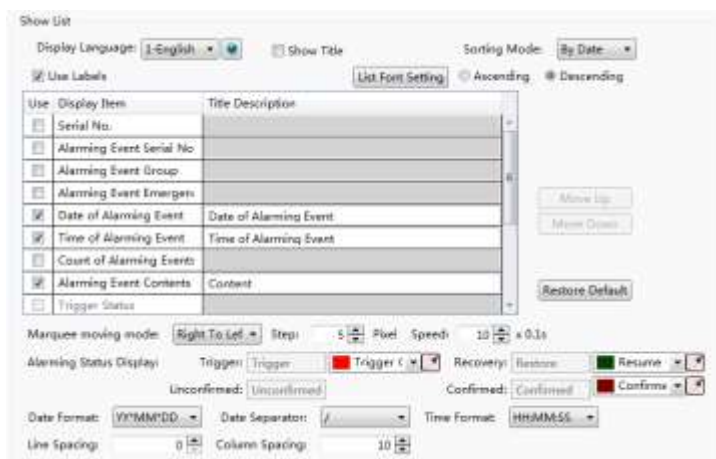

“Display Language”

VEDA HCT User Manual

The “Display Language” is selected to switch the current display language for editing the Title Description. The details are referred to: [Detailed manual/Setup/System Settings/Language Settings](#).

“Show Title”

The option “Show Title” is checked by default. If you do not want to display the title bar, you can remove the check.

“List Font Setting”

The button “List Font Setting” is used to set the font of the title bar. The details are referred to: [Detailed manual/ General functions/ Drawing/ Font settings](#).

“Sorting Mode”

The “Sorting Mode” sets the arrangement order of the alarms and events.

If you set “By Date” and select the option “Descending”, the latest event will be displayed on the top.

If you set “By Level” and select the option “Descending”, the higher level events are displayed on the top.

If you select the option “Ascending”, the display order is inverse.

“Use Labels”

If you check the option “Use Labels”, the contents of the “Title Description” can use the default or you can edit them.

If you don’t check the option “Use Labels”, the contents of the “Title Description” can be set by using the text in the text library. It is shown as below. You can click the button

 to open the text library and select the required text. The details of the Text Library are referred to: [Detailed manual/Library/Text Library](#).

VEDA HCT User Manual

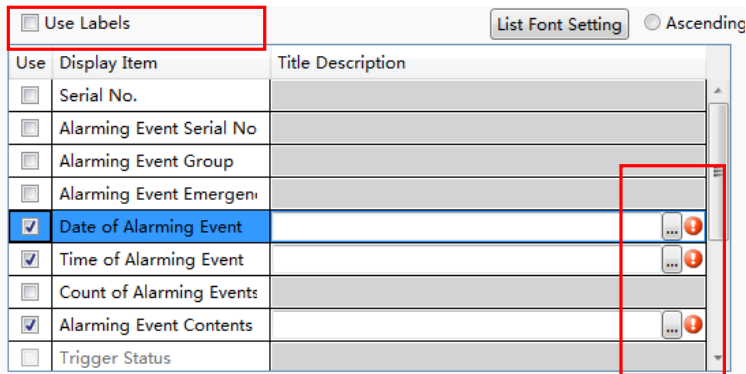

“List settings”

The title bar contents of the alarm bar are set in the below table. The contents of the title bar can be set to display by checking it. But the gray Display Items cannot be checked.

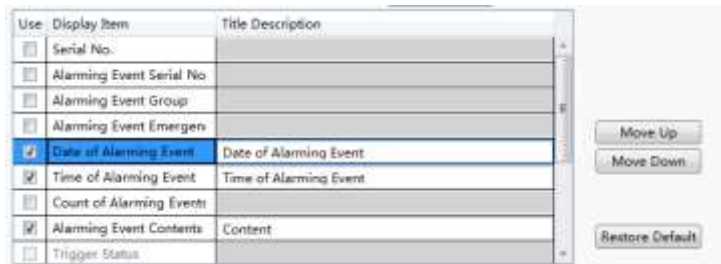

You can use the button "Move Up" or "Move Down" to modify the order of the display items arrangement. The content on the top row will display on the left of the alarm bar. You can restore the default arrangement by clicking the button "Restore Default".

“Marquee moving mode”

You can set the scrolling direction of the alarm contents, the step size (Step: 1 to 255 pixels), and the scrolling speed (Speed: 1 to 255*0.1s).

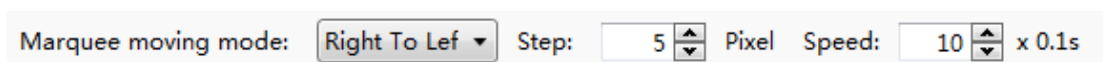

“Alarm Status Display”

The alarm bar only displays the triggered alarms and events. So only the Trigger Color can be changed.

VEDA HCT User Manual

“Date Format”

The screenshot shows a configuration panel for "Alarming Status Display". It includes several settings:

- Trigger:** A dropdown menu set to "Trigger" with a red square icon and a "Trigger C" label.
- Recovery:** A dropdown menu set to "Restore" with a green square icon and a "Resume" label.
- Unconfirmed:** A dropdown menu set to "Unconfirmed".
- Confirmed:** A dropdown menu set to "Confirmed" with a red square icon and a "Confirme" label.
- Date Format:** A dropdown menu set to "YY*MM*DD".
- Date Separator:** A dropdown menu set to "/".
- Time Format:** A dropdown menu set to "HH:MM:SS".
- Line Spacing:** A numeric input field set to "0".
- Column Spacing:** A numeric input field set to "10".

The “Date Format” is used to set the sort order of year (YY), month (MM) and day (DD). The “Date Separator” is used to set the separator among year, month and day. The “Time Format” is used to set the time display format.

“Line Spacing and Column Spacing”

The “Line Spacing” and the “Column Spacing” are to set the ranks spacing of the alarm bar. The unit is pixel and the range is 0-255.

- Table

The settings of the “Table” property TAB are referred to: [Detailed manual/General functions/Drawing/Table Drawing](#).

- Display

The settings of the “Display” property TAB are referred to: [Detailed manual/General functions/Drawing/Display](#).

4.6.13.2 Historical Data Display

The function of the “Historical Data Display” is to display the sampling data in tabular form. The display is continuously refreshed according to the specified sampling frequency.

VEDA HCT User Manual

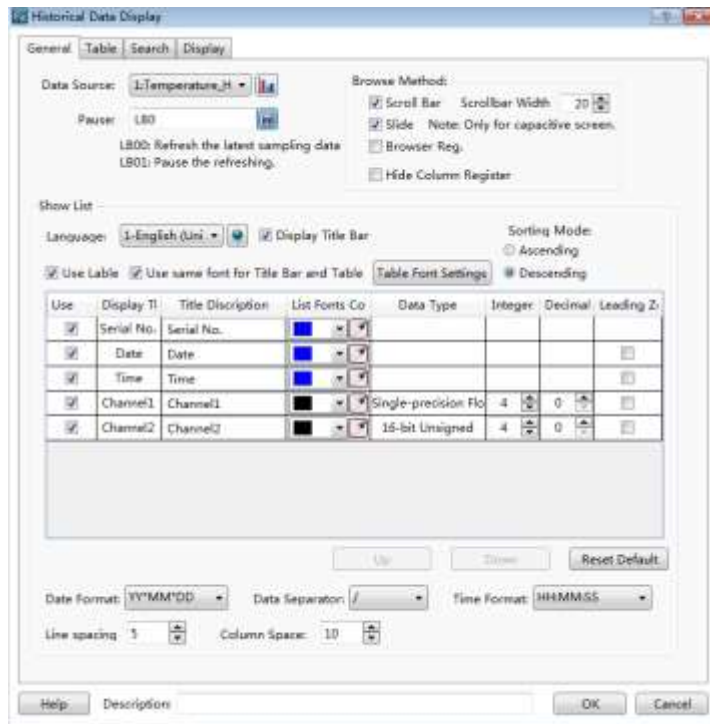

4.6.13.2.1 General

- Data Source

Select a data sampling from the pull-down list. If there is no data sampling, you can quickly build one by clicking the button “”. The details are referred to: [Detailed manual/Setup/System Settings/Data Sampling](#).

- Pause

A bit register address can be set to pause or start the display of the historical data sampling.

For example: set a bit address LB0 for the option “Pause”. Then when LB0 is OFF, the latest data sampling is refreshed. When LB0 is ON, the refreshing is paused.

Note:

The refreshing is paused, but sampling is not stopped. All sampling data will be refreshed.

- Browse Method

The “Browse Method” includes “Scroll Bar”, “Slide”, “Browser” and “Hide Column Register”.

VEDA HCT User Manual

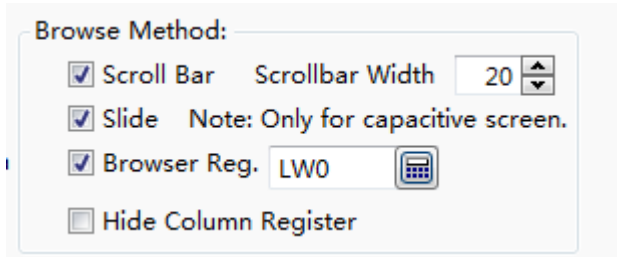

➤ Scroll Bar

When checking the option “Scroll Bar”, the list will appear scroll bar for viewing. The scrollbar width can be customized. The unit is pixel.

➤ Slide

You can check the option “Slide” in order to view by sliding the screen. This function is supported by the capacitive screen devices.

➤ Browser

The option “Browser” can be checked when you need to view multiple pages. A word register needs to be specified to define the current page. The default is that 0 represents the records on the current day, 1 represents the records on yesterday, 2 represents the records on the day before yesterday, and so on. The word register input is referred to: [Detailed manual/General functions/Address editor/Standard Byte Address Input](#).

➤ Hide Column Register

If you check the option “Hide Column Register”, a word register can be set. The value of the word register is used to control the display or hiding of each column.

● Show List

VEDA HCT User Manual

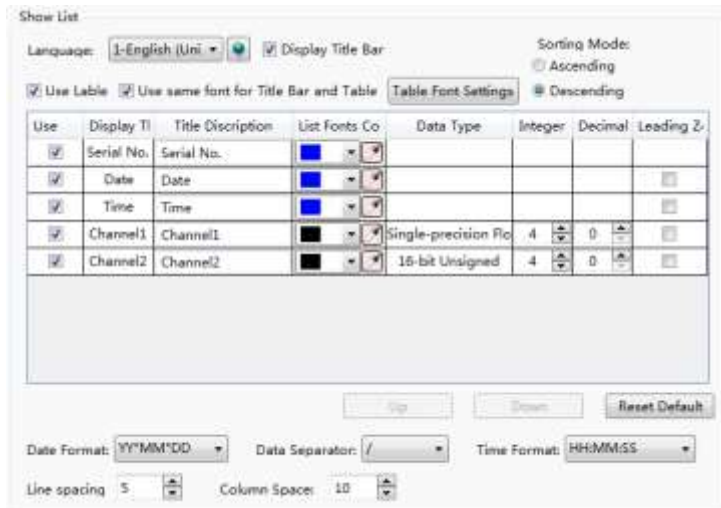

➤ Language

The “Display Language” is selected to switch the current display language for editing the Title Description. The details are referred to: [Detailed manual/ Setup/ System Settings/ Language Settings.](#)

➤ Display Title Bar

The option “Display Title Bar” is checked by default. If you do not want to display the title bar, you can remove the check.

➤ Table Font Settings

It is used to set the font of the title bar. The details are referred to: [Detailed manual/General functions/Drawing/Font settings.](#)

➤ Use Label

By default, the option “Use Label” is checked. The contents of the “Title Description” can use the default or you can edit them. It is shown as below.



If you don't check the option “Use Label”, the contents of the “Title Description” can be set by using the text in the text library. It is shown as below. You can click the button “...” to open the text library and select the required text. It is shown as below.

VEDA HCT User Manual

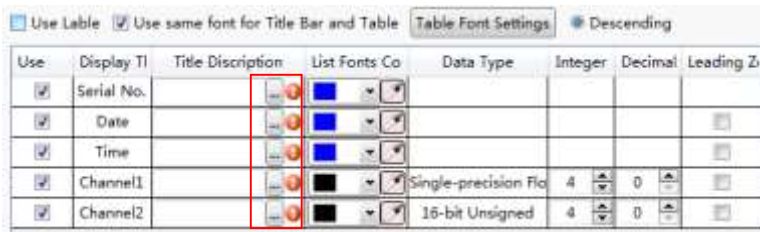

The details of the Text Library are referred to: [Detailed manual/Library/Text Library](#).

➤ Use same font for Title Bar and Table

By default, the font of the contents in the list is same to the font of the title bar. If you want to define the font of the contents in the list, you can remove the check and set the font by clicking the button "Table Font Settings".

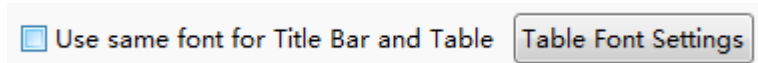

The details are referred to: [Detailed manual/General functions/Drawing/Font settings](#).

➤ Sorting Mode

There are two Sorting Modes: Ascending and Descending. When the option "Ascending" is selected, the oldest record is displayed in the first row. When the option "Descending" is selected, the newest record will display on the first row.

➤ List Settings



You can select the required contents to display in the title bar by checking in the "Use" column. For the order of the contents arrangement, you can use the button "Move Up" or "Move Down" to modify it. The content on the top row will display on the left of the Historical Data Display List. You can restore the default arrangement by clicking the button "Restore Default".

➤ Date and Time Format

VEDA HCT User Manual

The “Date Format” is used to set the sort order of year (YY), month (MM) and day (DD). The “Date Separator” is used to set the separator among year, month and day. The “Time Format” is used to set the time display format.

➤ Line Spacing and Column Space

The “Line Spacing” and the “Column Space” are to set the ranks spacing of the alarm list. The unit is pixel and the range is 0-255. The line space is a unified value, and the column space can be set one by one and can be set to the same value.

4.6.13.2.2 Table

The settings of the “Table” property TAB are referred to: [Detailed manual/ General functions/ Drawing/ Table Drawing](#).

4.6.13.2.3 Search

● Enable Search Function

Check the option "Enable Search Function" to use the search function.

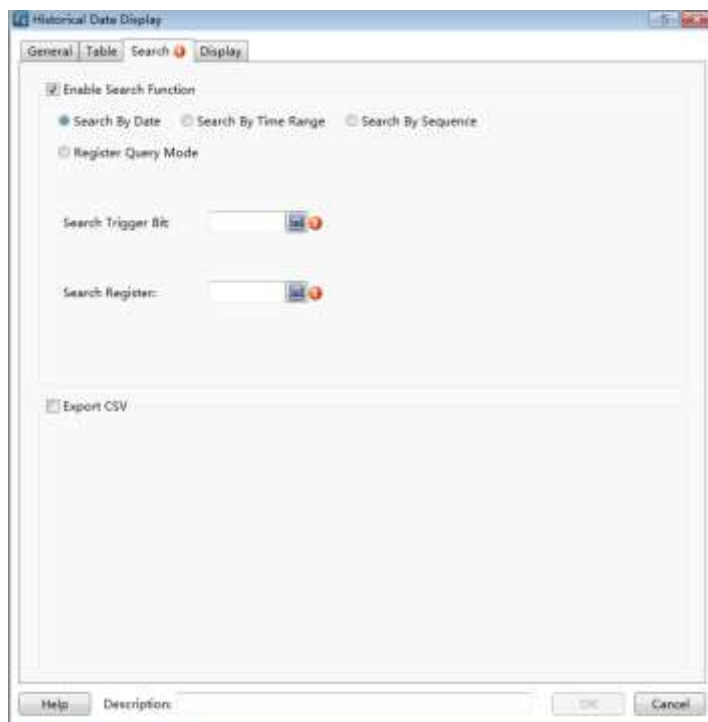

➤ Search mode

There are four search modes supported: “Search By Date”, “Search By Time Range”, “Search By Sequence” and “Register Query Mode”.

VEDA HCT User Manual

The “Register Query Mode” is a dynamic search mode. You can specify a word register to dynamically adjust the search mode. If the word register is 0, the “Search By Date” mode is used. If it is 1, the “Search By Time Range” mode is used. If it is 2, the “Search By Sequence” mode is used. The word register address input method is referred to: [Detailed manual/General functions/Address editor/Standard Byte Address Input](#).

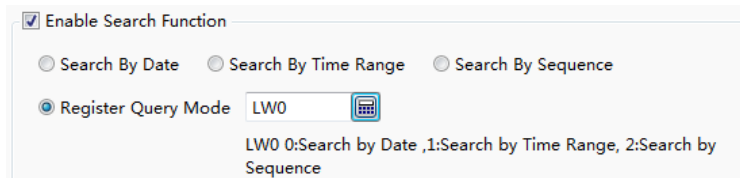

➤ Search Trigger Bit

The option “Search Trigger Bit” is used to specify a bit register to trigger the search function. Note that the search function is not edge-triggered mode. When set the trigger bit 1, the alarm list displays the filtered results. After setting the trigger bit 0, the list will display the results which are not filtered. The bit address input method is referred to: [Detailed manual/General functions/Address editor/Standard Bit Address Input](#).

➤ Search Register

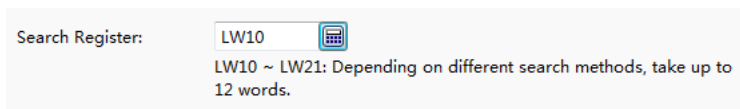

The “Search Register” is used to specify the first word register address for the search function. The number of the word registers is depending on the search mode. The function of the word registers used to search is different for the different search mode. You can get the information of the used word registers according to the text displayed under the first word register address. The word address input method is referred to: [Detailed manual/General functions/Address editor/Standard ByteAddress Input](#).

● Export CSV

The option “Export CSV” is referred to: [Detailed manual/ General functions/ Drawing/ Export CSV](#).

4.6.13.2.4 Display

The settings of the “Display” property TAB are referred to: [Detailed manual/General functions/Drawing/Display](#).

4.6.13.3 Operator Log

The function of the “Operation Log” is to record the required detailed operation of the HMI device, such as a button is triggered at a certain time, a value is modified at another certain time, and so on. The “Operation Log component displays the detailed operating records in the list form. You can search the records or export them.

VEDA HCT User Manual

Note 1:

For the created components, the operations are not recorded by default. To record the operation of a component, check the "Records Operation" option in the "Control Settings" property TAB and click the button "Set" to set the operation information. The details are referred to: [Detailed manual/General functions/Drawing/Control settings](#) and [Detailed manual/General functions/Drawing/Label](#).

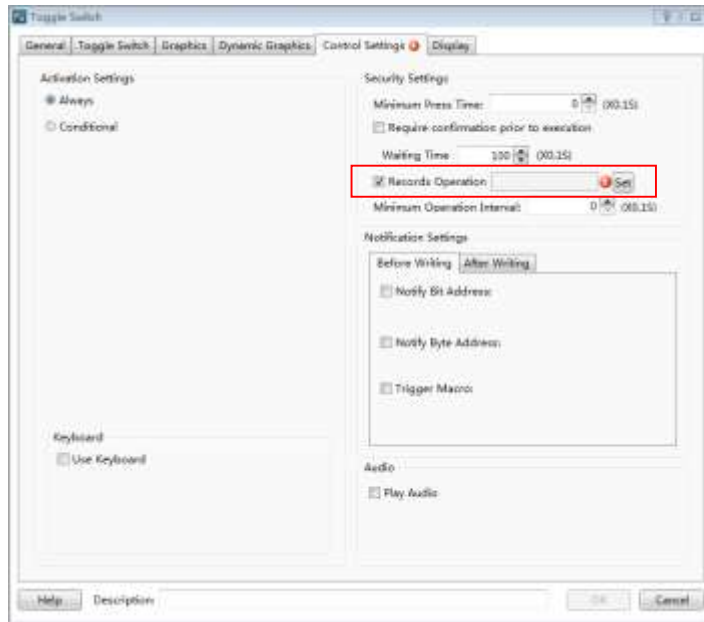

Note 2:

Only when the user privilege is enabled and a user logs in, the operator user name will be recorded and displayed. When the user privilege is not enabled or there is no user to log in, the user name is displayed a blank in the operation records.

4.6.13.3.1 General

The general attributes of the "Operator Log" are set in the "General" property TAB.

VEDA HCT User Manual

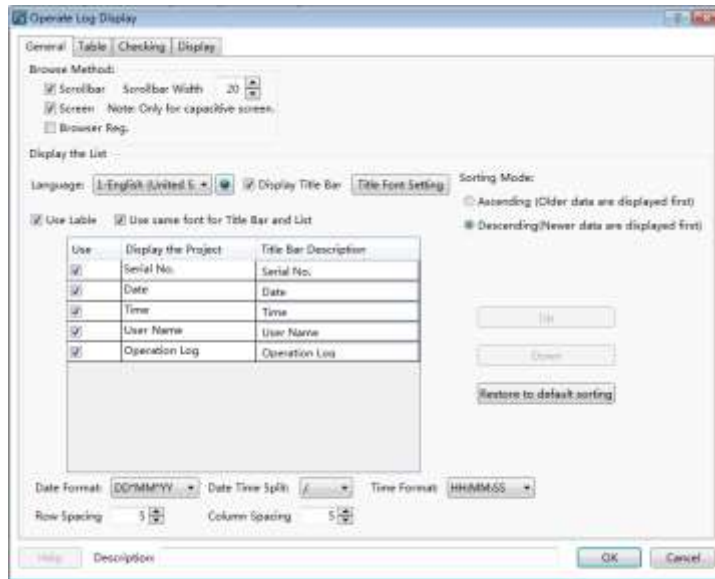

- Browse Method

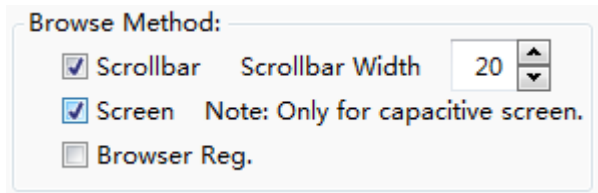

There are three browse methods: “Scrollbar”, “Screen” and “Browser”.

The scroll bar will display in the alarm list if you check the option “Scrollbar”. You can view the alarms by using the scroll bar. The “Scrollbar Width” needs to be set. The unit of it is pixel.

You can check the option “Screen” in order to view the records by sliding the screen. This function is supported by the capacitive screen devices.

The option “Browser” can be checked when you need to view multiple pages. A word register needs to be specified to define the current page. The default is that 0 represents the records on the current day, 1 represents the records on yesterday, 2 represents the records on the day before yesterday, and so on. The word register input is referred to: [Detailed manual/General functions/Address editor/Standard Byte Address Input](#).

- Display the list

VEDA HCT User Manual

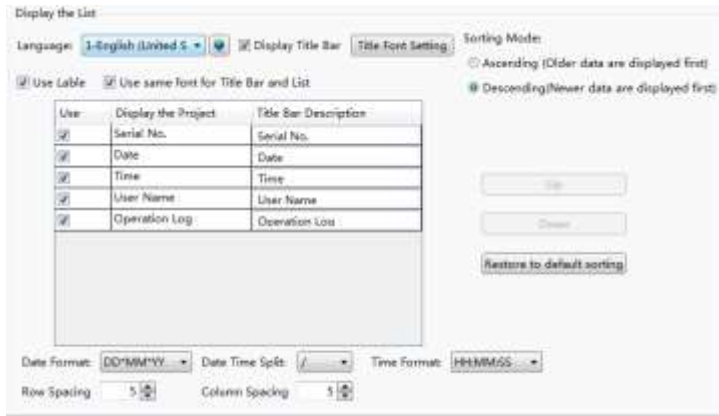

➤ Language

The “Language” is selected to switch the current display language for editing the Title Description. The details are referred to: [Detailed manual/ Setup/ System Settings/ Language Settings](#).

➤ Display Title Bar

The option “Display Title Bar” is checked by default. If you do not want to display the title bar, you can remove the check.

➤ Title Font Setting

It is used to set the font of the title bar. The details are referred to: [Detailed manual/General functions/Drawing/Font settings](#).

➤ Use label

By default, the option “Use Label” is checked. The contents of the “Title Bar Description” can use the default or you can edit them. It is shown as below.

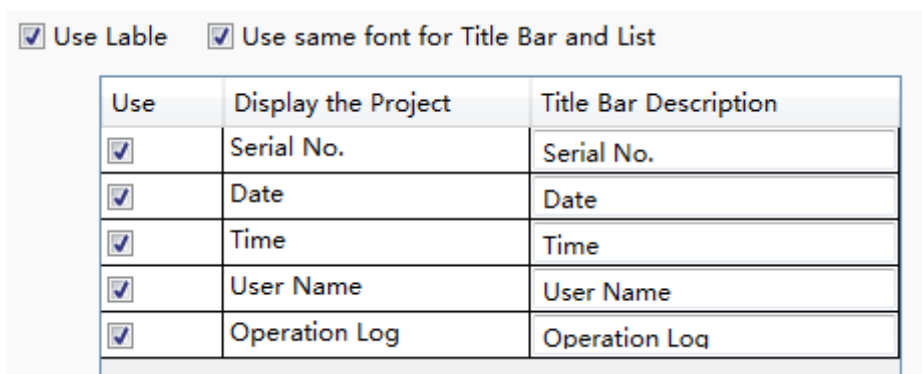

If you don't check the option “Use Label”, the contents of the “Title Bar Description” can be set by using the text in the text library. It is shown as below. You can click the button “...” to open the text library and select the required text. It is shown as below.

VEDA HCT User Manual

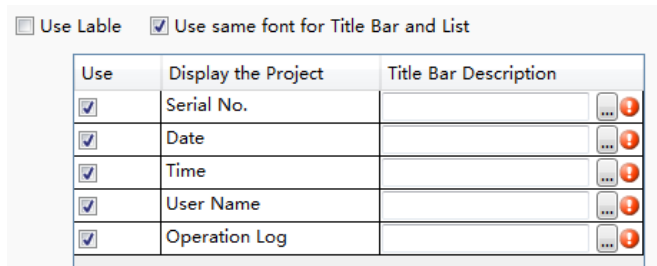

The details of the Text Library are referred to: [Detailed manual/Library/Text Library](#).

➤ Use same font for Title Bar and List

By default, the font of the contents in the list is same to the font of the title bar. If you want to define the font of the contents in the list, you can remove the check and set the font by clicking the button “Table Font Settings”.

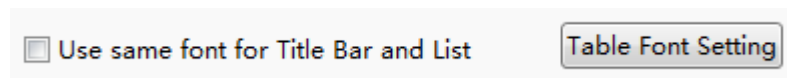

The details are referred to: [Detailed manual/General functions/Drawing/Font settings](#).

➤ Sorting Mode

There are two Sorting Modes: Ascending and Descending. When the option “Ascending” is selected, the oldest record is displayed in the first row. When the option “Descending” is selected, the newest record will display on the first row.

➤ List Settings

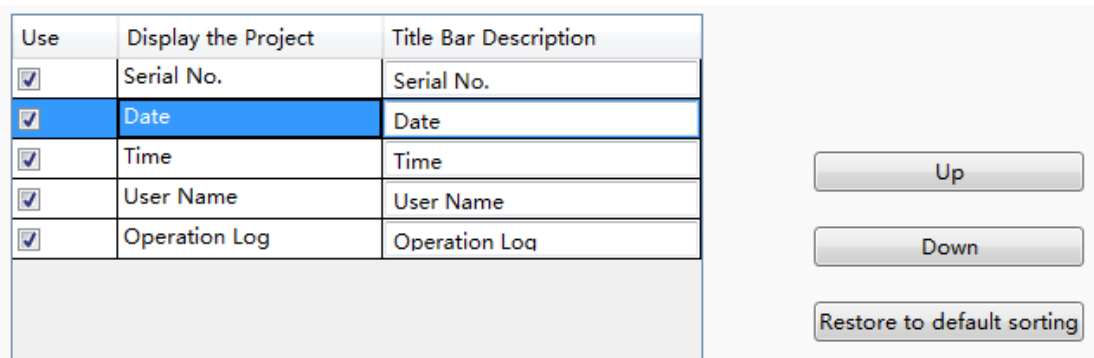

You can select the required contents to display in the title bar by checking in the “Use” column. For the order of the contents arrangement, you can use the button "Up" or "Down" to modify it. The content on the top row will display on the left of the Operator Log List. You can restore the default arrangement by clicking the button "Restore to default sorting".

VEDA HCT User Manual

➤ Date and Time Format

The “Date Format” is used to set the sort order of year (YY), month (MM) and day (DD). The “Date Time Split” is used to set the separator among year, month and day. The “Time Format” is used to set the time display format.

➤ Row Spacing and Column Spacing

The “Row Spacing” and the “Column Spacing” are to set the ranks spacing of the operator log list. The unit is pixel and the range is 0-255.

4.6.13.3.2 Table

The settings of the “Table” property TAB are referred to: [Detailed manual/ General functions/ Drawing/ Table Drawing](#).

4.6.13.3.3 Checking

● Enable Search Function

Check the option "Enable Search Function" to use the search function.

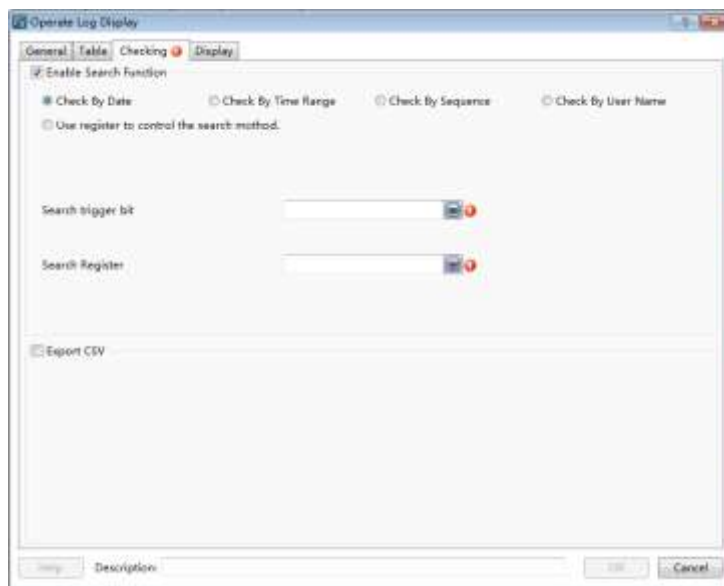

➤ Search mode

There are four fixed search modes supported: “Check By Date”, “Check By Time Range”, “Check By Sequence” and “Check By User Name”.

The “Use register to control the search method” is a dynamic search mode. You can specify a word register to dynamically adjust the search mode. If the word register is 0, the “Check By Date” mode is used. If it is 1, the “Check By Time Range” mode is used. If it is 2, the “Check By Sequence” mode is used. If it is 3, the “Check By User Name”

VEDA HCT User Manual

mode is used. The word register address input method is referred to: [Detailed manual/General functions/Address editor/Standard Byte Address Input](#).

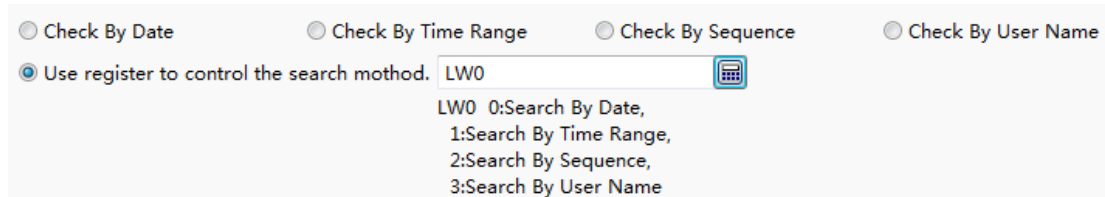

The screenshot shows a search configuration interface with four radio buttons: "Check By Date", "Check By Time Range", "Check By Sequence", and "Check By User Name". The "Use register to control the search method." option is selected. Below it, a text input field contains "LW0" and a calendar icon. A dropdown menu is open, listing: "0:Search By Date,", "1:Search By Time Range,", "2:Search By Sequence,", and "3:Search By User Name".

➤ Search trigger bit

The option “Search trigger bit” is used to specify a bit register to trigger the search function. Note that the search function is not edge-triggered mode. When set the trigger bit 1, the alarm list displays the filtered results. After set the trigger bit 0, the list will display the results which are not filtered. The bit address input method is referred to: [Detailed manual/General functions/Address editor/Standard Bit Address Input](#).

➤ Search Register

The “Search Register” is used to specify the first word register address for the search function. The number of the word registers is depending on the search mode. The function of the word registers used to search is different for the different search mode. You can get the information of the used word registers according to the text displayed under the first word register address. The word address input method is referred to: [Detailed manual/General functions/Address editor/Standard ByteAddress Input](#).

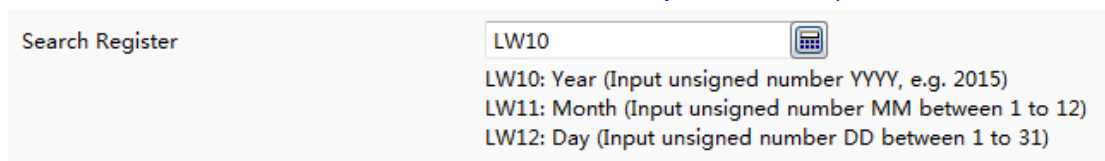

The screenshot shows a "Search Register" configuration interface. It has a text input field with "LW10" and a calendar icon. Below the input field, there are three lines of text: "LW10: Year (Input unsigned number YYYY, e.g. 2015)", "LW11: Month (Input unsigned number MM between 1 to 12)", and "LW12: Day (Input unsigned number DD between 1 to 31)".

● Export CSV

The option “Export CSV” is referred to: [Detailed manual/ General functions/ Drawing/ Export CSV](#).

4.6.13.3.4 Display

The settings of the “Display” property TAB are referred to: [Detailed manual/General functions/Drawing/Display](#).

4.6.14 Tools

The “Tools” component includes “Touch Trigger”, “Canvas”, “Calendar Clock” and “QR-Code”.

VEDA HCT User Manual

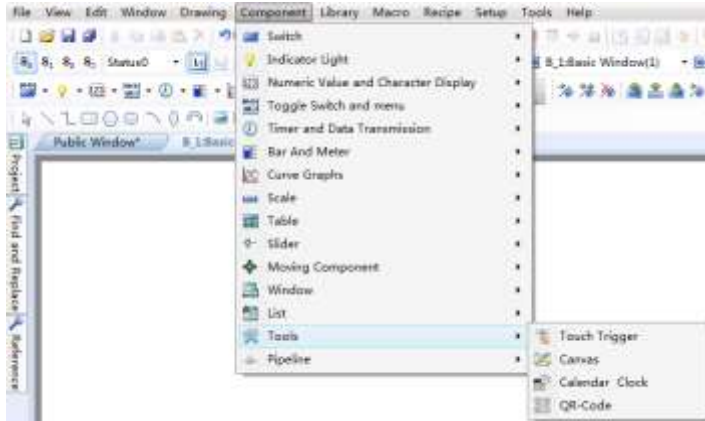

4.6.14.1 Touch Trigger

The “Touch Trigger” component can be used in the occasions that a component or more components can be triggered not by touching. That is, all components which occupy the active area of the touch trigger component can be triggered when the register specified by the touch trigger component meets the conditions.

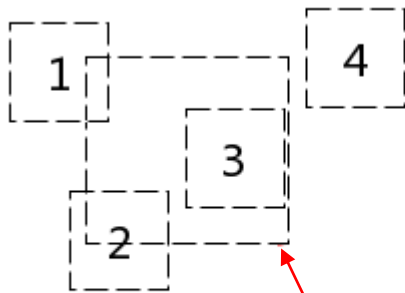

The area of a touch trigger component

As shown as above, when the trigger condition of the touch trigger component is met, the components 1,2 and 3 will be triggered, while component 4 will not be triggered.

The property page of the “Touch Trigger” component is shown as below.

VEDA HCT User Manual

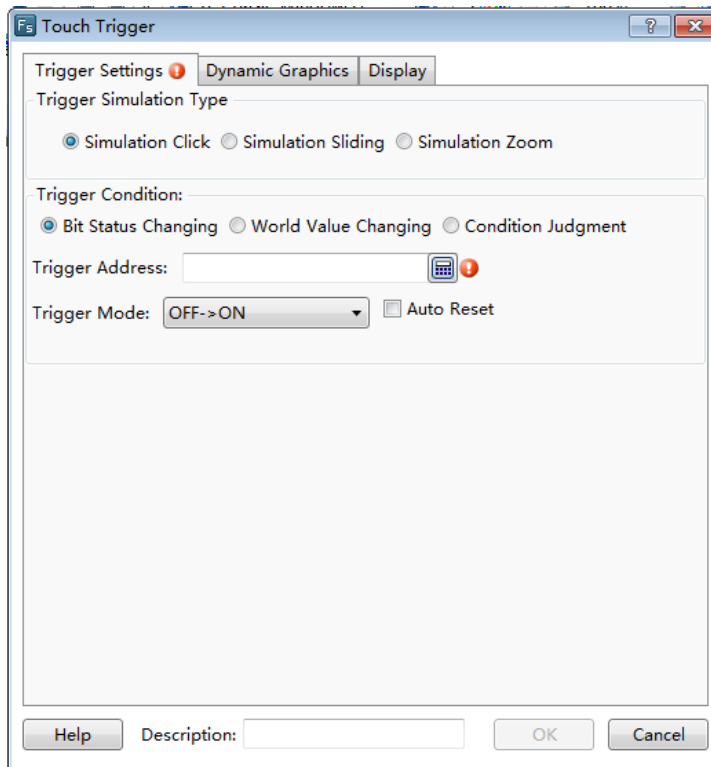

4.6.14.1.1 Trigger Simulation Type

The “Trigger Simulation Type” refers to the trigger type of the “Touch Trigger” component. It includes “Simulation Click”, “Simulation Sliding” and “Simulation Zoom”. They are corresponding to the trigger actions when the trigger conditions of the touch trigger component are met.

- Simulation Click

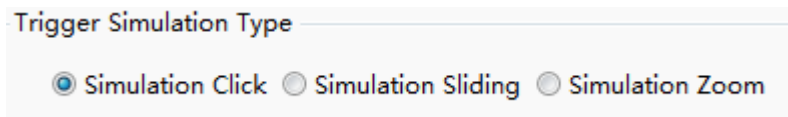

When the trigger conditions of the touch trigger component are met, the components which occupy the active area of the touch trigger component will execute the click action, such as clicking a switch button.

- Simulation Sliding

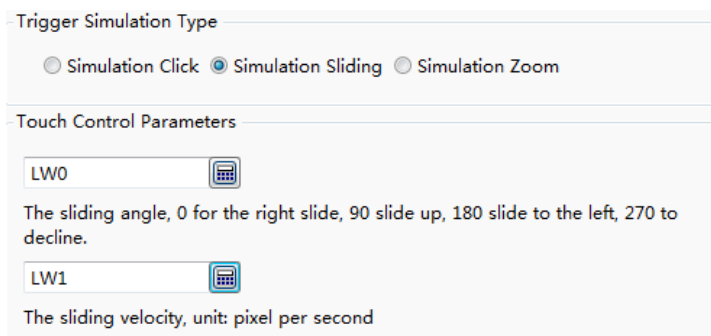

VEDA HCT User Manual

When the trigger conditions of the touch trigger component are met, the components which occupy the active area of the touch trigger component will execute the sliding action within this area. The sliding action is controlled by two word registers. The first word register controls the sliding angle, 0 for sliding to right, 90 for sliding up, 180 for sliding to left, 270 for sliding down. The second word register controls the sliding velocity. The sliding velocity unit is pixel per second. The address input of the word register is referred to: [Detailed manual/General functions/Address editor/Standard ByteAddress Input](#).

● Simulation Zoom

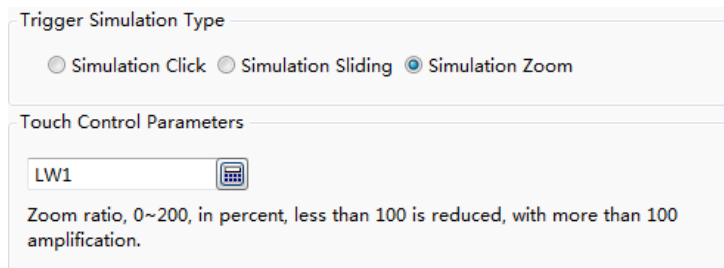

When the trigger conditions of the touch trigger component are met, the components which occupy the active area of the touch trigger component will execute the zooming action within this area, such as viewing the trend curve by zooming.

The zoom ratio is controlled by a word register. The range of zoom ratio is 0-200, in percent. The value 1-200 is legal. It represents the zoom percentage which less than 100 is corresponding to reducing and more than 100 is corresponding to amplification. The address input of the word register is referred to: [Detailed manual/ General functions/ Address editor/ Standard ByteAddress Input](#).

4.6.14.1.2 Triggering Condition

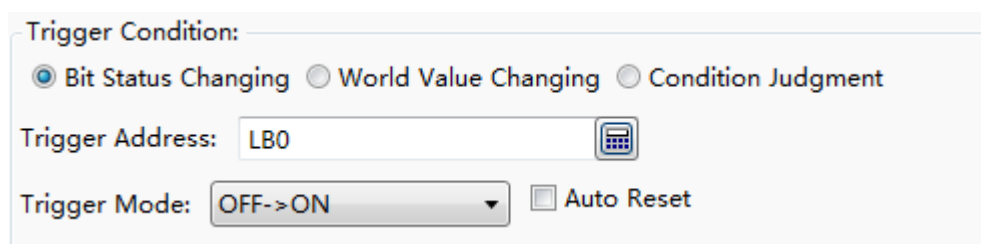

The “Trigger Condition” supports “Bit Status Changing”, “Word Value Changing” and “Condition Judgment”. The settings are referred to: [Detailed manual/Component/Timer and Data Transmission/Timer](#).

4.6.14.2 Canvas

The property page of the “Canvas” can be opened by clicking the menu command "Component/Tools/Canvas".

VEDA HCT User Manual

4.6.14.2.1 Monochrome Brush

You can control the graphics canvas by bit registers. You can modify the canvas color and the pen color, as shown as below.

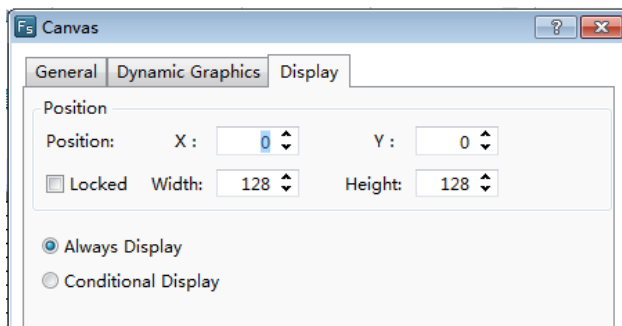
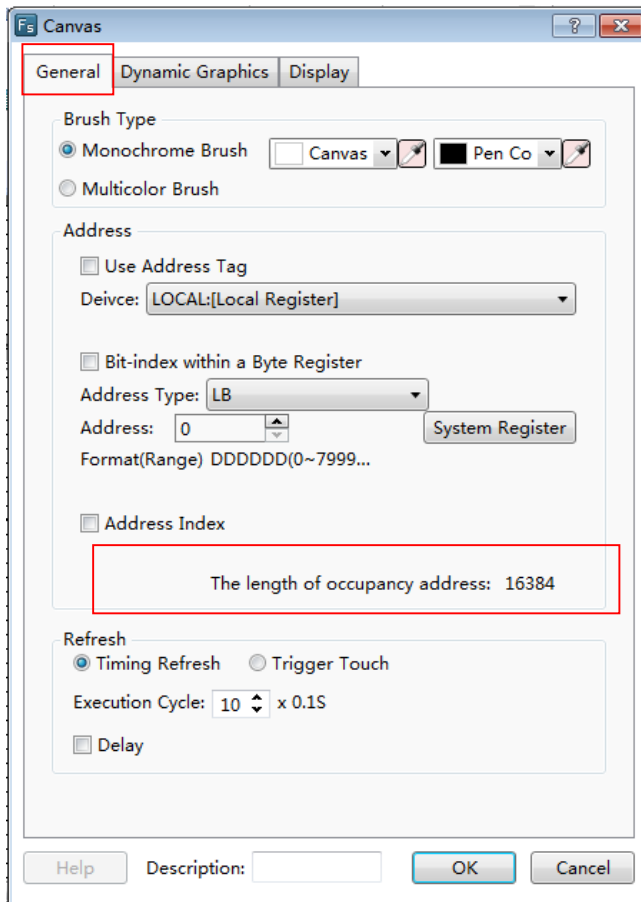

In the above settings, you can see that the Canvas Width is 128 and the Canvas Height is 128 in the "Display" property page. The size of the canvas is 128*128. So the occupied LB addresses number is 16384. It is displayed in the "General" property page. If any of the address LB0 ~ 160000 is 1, the corresponding pixel on the canvas is white. If it is 0, the corresponding pixel on the canvas is black. You can also check the "Bit-index within a Byte Register" to set the canvas. It is easy to program a complex graphic. You can set LW0=65535 (0xFFFF) directly if you want all LW0.0~ LW0.15 to be 1.

VEDA HCT User Manual

4.6.14.2.2 Multicolor Brush

The settings of the “Multicolor Brush” are similar to the monochrome brush. The default canvas color is white. Each pixel of the canvas is controlled by using word register addresses. The color of pen brush is based on the value of the corresponding word address according to the RGB565 form.

The RGB565 mode is a color mode which a pixel occupies two bytes. The first 5 bits in the low byte are used to indicate B (BLUE). The last 3 bits in the low byte + the first 3 bits in the high byte are used to indicate G (Green). The last 5 bits in the high byte are used to indicate R (RED).

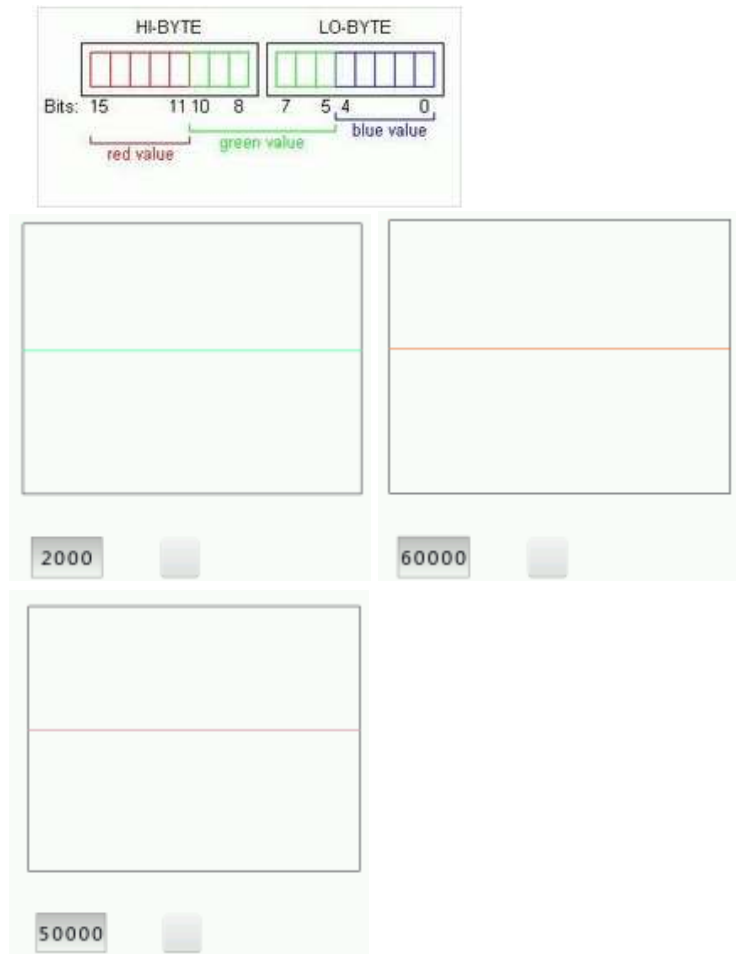

4.6.15 Pipeline

The “Pipeline” component includes three types: Horizontal, Vertical and Elbow.

VEDA HCT User Manual

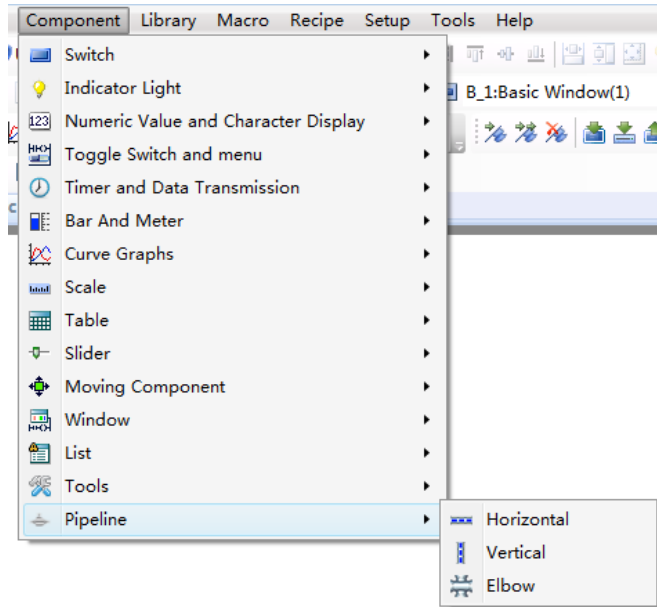

4.6.15.1 Horizontal

4.6.15.1.1 Pipeline

The Pipe Diameter and Pipe wall thickness should be given when you use a horizontal component. It is shown as below.

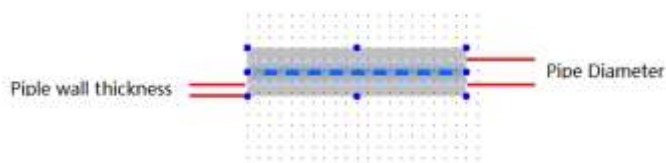
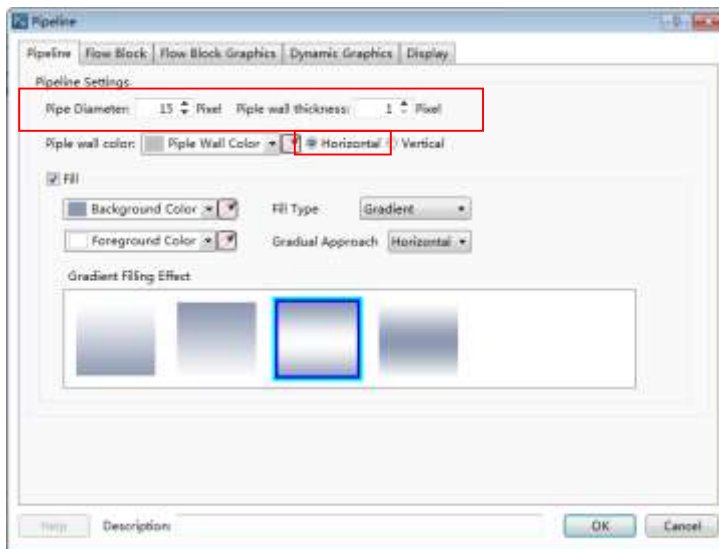

VEDA HCT User Manual

4.6.15.1.2 Flow Block

The “Flow Block” property page is mainly used to set the width and length of the pipe and the flow block. The flow direction and flow velocity parameters are also set here. It is shown as below.

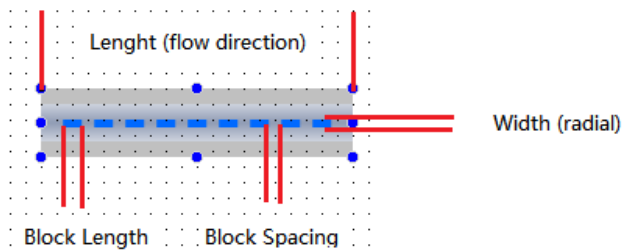
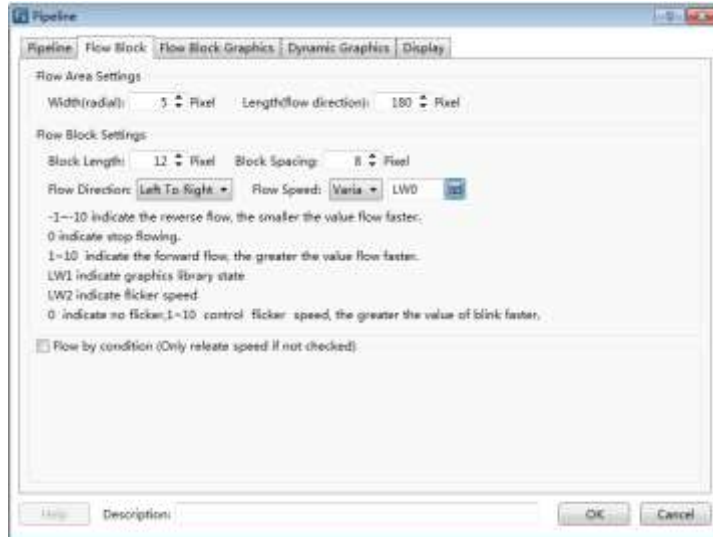

Note:

For example, the system will use LW0, LW1 and LW2 to control the flow block of the pipe when the Flow Speed is set LW0.

4.6.15.1.3 Flow Block Graphics

The graphic of the flow block is set here. You can edit the graphic and the display color in different status. It is shown as below.

VEDA HCT User Manual



4.6.15.1.4 Display settings

The overall height and width of the pipeline component are set here. The settings are shown as below. Note that the "Width" of the component should be greater than the length of the flow block and the "Height" of the component should be greater than the diameter of the pipeline.



4.6.15.2 Vertical

The settings of a vertical pipeline are similar to a horizontal pipeline. The attribute of vertical or horizontal can be switched directly in the "Pipeline" property page. It is shown as below.

VEDA HCT User Manual



4.6.15.3 Elbow

It is mainly used to connect the horizontal pipeline and the vertical pipeline. There are many kinds of elbows in the graphics library. You can use it by clicking the button “Import” to select one to use. They are shown as below.

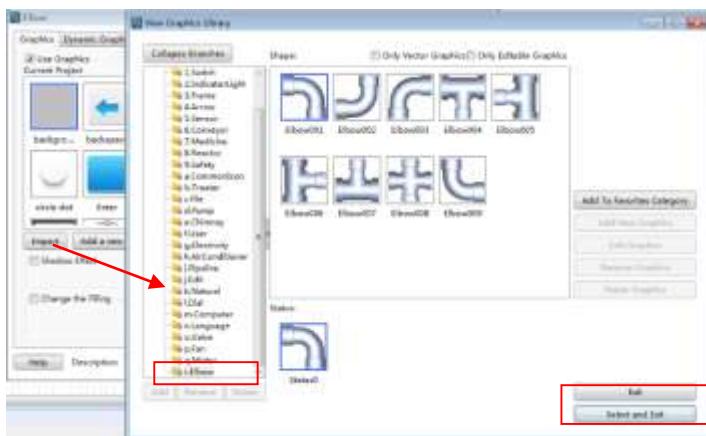

4.7 Library

4.7.1 Graphics Library

Many graphics need to be used in the project configuration. The VEDA HCT software has a graphics library which provides rich graphics. The users can also add their own pictures to the library to use.

The commands of Graphics Library include “Add Graphics” and “Browse Graphics Library”. You can use any of these commands by clicking the menu command "Library/Add

VEDA HCT User Manual

Graphics" or "Library/Browse Graphics Library". You can also double-click the "Library/Add Graphics" or "Library/ Browse Graphics Library" in the project tree.

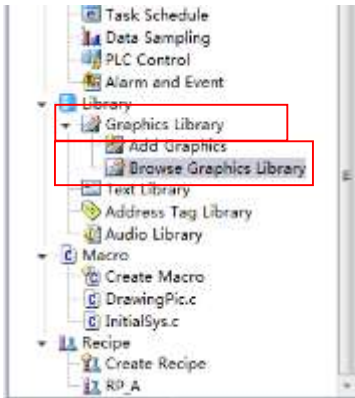

4.7.1.1 Add Graphics

The "Add Graphics" window is shown as below.

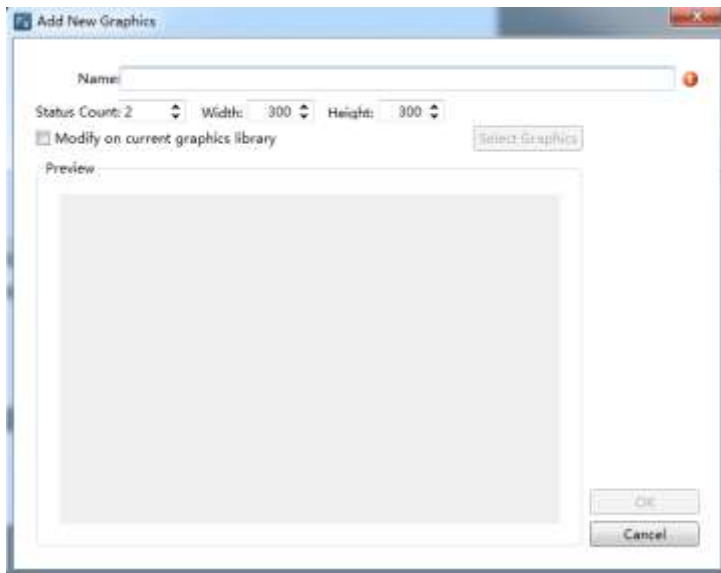

4.7.1.1.1 Name, Status Count, Width and Height

You need to give a name for the new added graphic. A graphic may have many statuses. You should set the number of the statuses for the option "Status Count". And you should also set the Width and the Height for your graphic.

VEDA HCT User Manual

4.7.1.1.2 Modify on current graphics library

Please check the option "Modify on current graphics library" if you want to modify the selected graphic from the graphics library. Then you can click the button "Select Graphics" to select a graphic from the library.

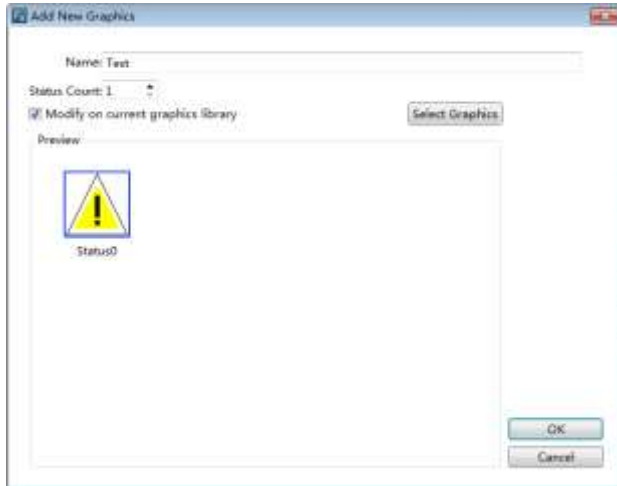

4.7.1.1.3 Edit

Click the button "OK" to confirm. Then the graphic editor window is displayed. The content of the editor window is corresponding to the selected status. It is shown as below.

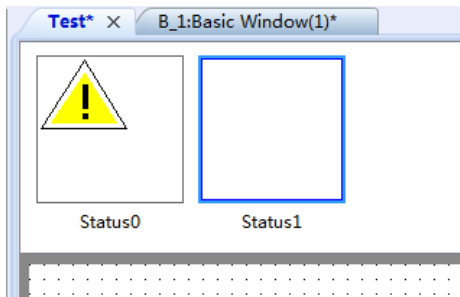

4.7.1.2 Browse Graphics Library

The menu command "Browse Graphics Library" is used to open the "View Graphics Library". It is shown as below.

VEDA HCT User Manual

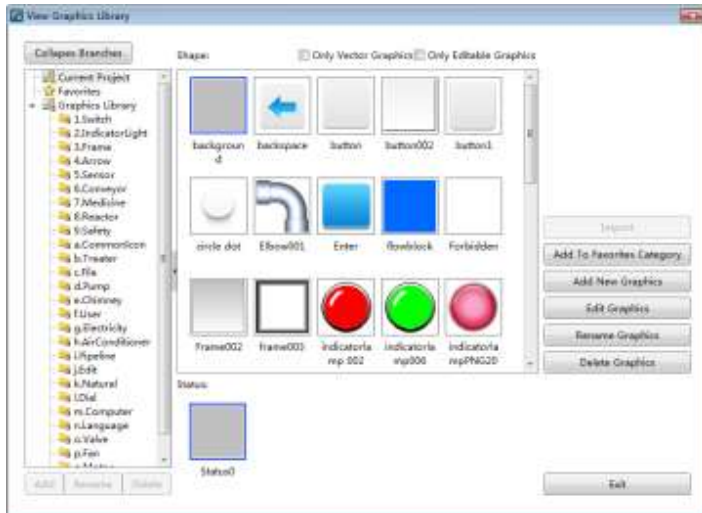

4.7.1.2.1 “Only Vector Graphics” and “Only Editable Graphics”

You can filter to display the graphics by check the “Only Vector Graphics” or the “Only Editable Graphics”.

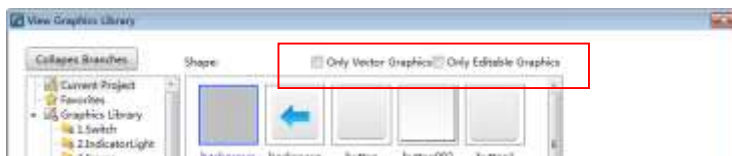

4.7.1.2.2 Add, Edit and Rename Graphics

You can add a new graphic to the library by clicking the button “Add New Graphics”. After select a graphic in the library, you can modify it by clicking the button “Edit Graphics” and rename it by clicking the button “Rename Graphics”.

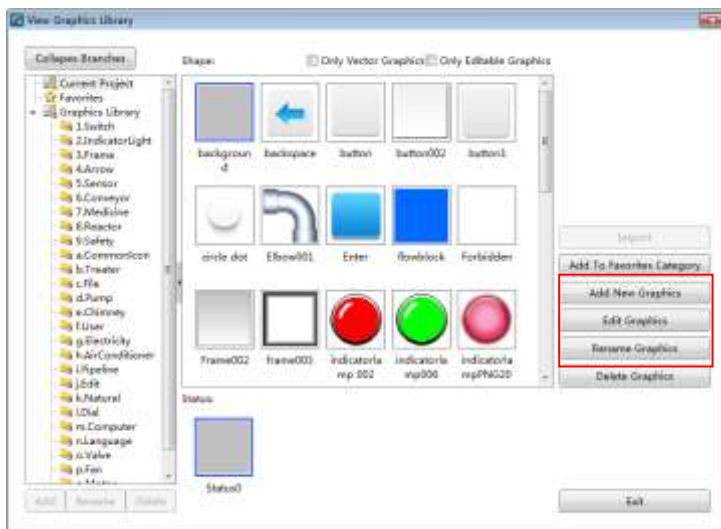

4.7.1.2.3 “Collapse Branches” and “Expand Branches”

VEDA HCT User Manual

There are rich graphics in the Graphics Library, such as Switch, Frame, Arrow, and so on. You can view the directory on the left area of the “View Graphics Library” window by clicking the button “Expand Branches” and select a required graphic from the directory.

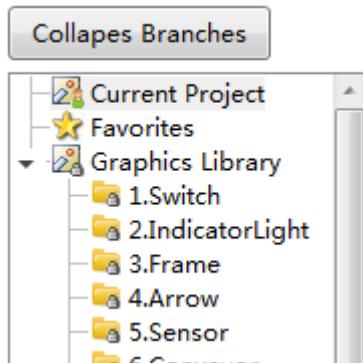

4.7.1.2.4 Favorites

The users can select favorite or popular graphics into the “Favorites” or a category under the “Favorites”. The category under the “Favorites” can be added by clicking the button “Add”. It can be renamed by clicking the button “Rename” or deleted by clicking the button “Delete”.



The selected graphic of the Graphics Library can be added to the Favorites or a **category** of the Favorites by clicking the button “Add To Favorites Category”.

VEDA HCT User Manual

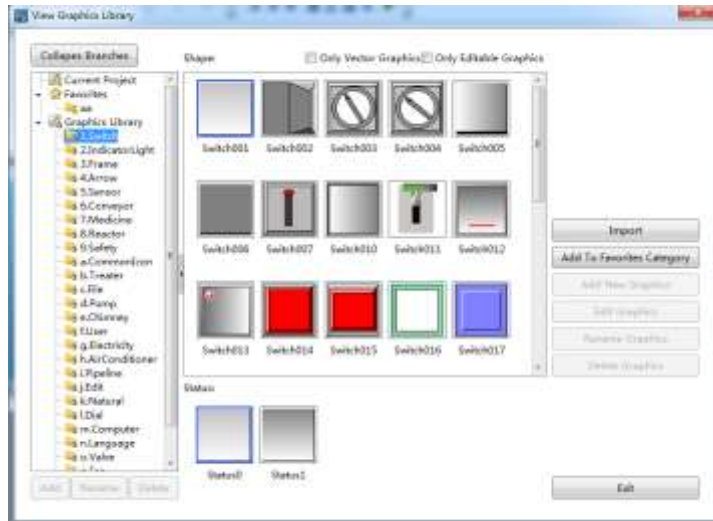

4.7.2 Text Library

The text can be saved in the form of multi-languages and multi-statuses by using the function of the Text Library. It can facilitate the users to use the text and modify it together in the project.

The Text Library can be opened by clicking the menu command “Library/ Text Library” or double-click the “Library/ Text Library” in the project tree.

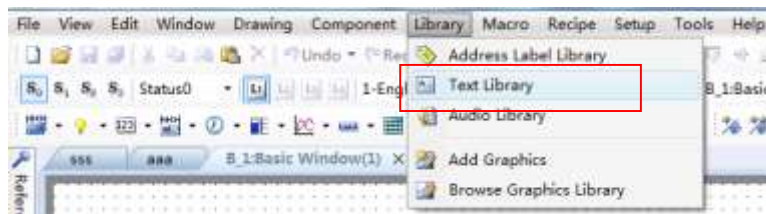

VEDA HCT User Manual

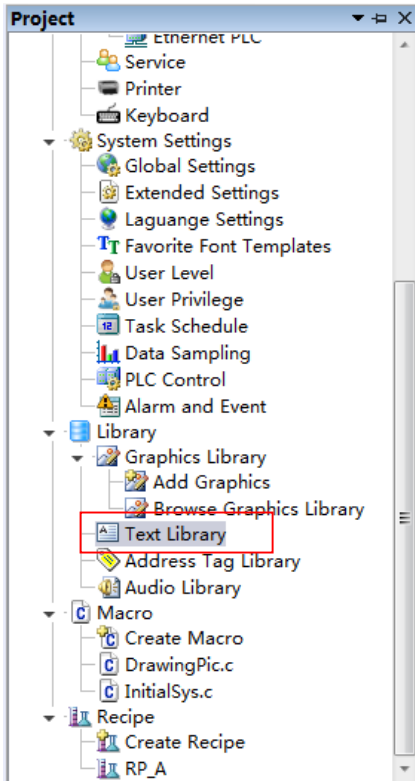

The “Text Library” window will pop up. It is shown as below.



4.7.2.1 Search

After enter the name required to find and click the button “Search”, all items which match the content will be found out.

Note that only the name is supported to find. The content in different language is not supported to search.

4.7.2.2 Language Display

VEDA HCT User Manual

After click the button “Language Display”, the “Language Display” window will pop up. It is shown as below.

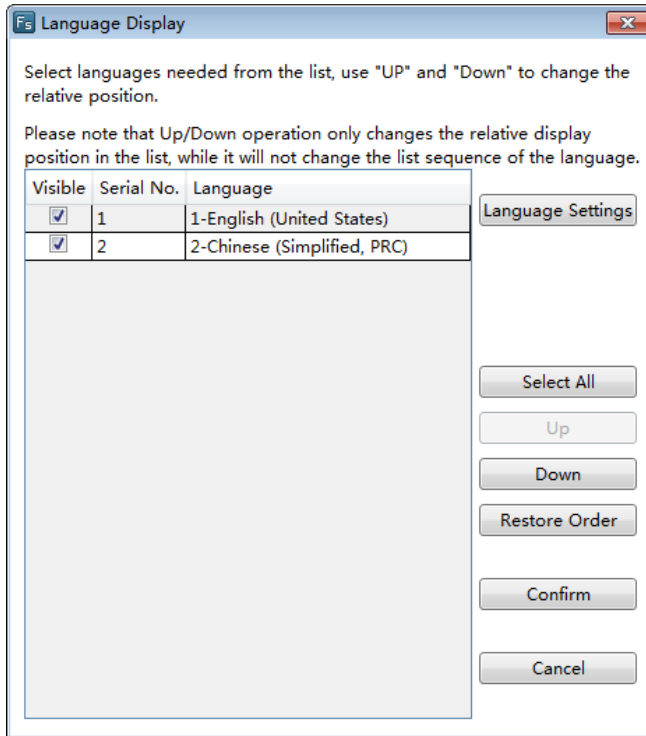

4.7.2.2.1 Language Settings

After clicking the button “Language Settings”, the “Language Settings” property page will be opened. You can add or delete language and set the display color, size and other information here. The details of the “Language Settings” are referred to: [Detailed manual/ Setup/ System Settings/Language Settings](#).

4.7.2.2.2 Other settings

The checked languages will be displayed in the “Text Library” window. And you can check all the languages by clicking the button “Select All”. Meanwhile, you can modify the order of the languages by clicking the button “Up” or “Down” after select a language.

Note:

The settings are valid for the language display effect in the “Text Library” window. It does not change the order of languages.

4.7.2.3 Sort by Name

After clicking the button “Sort by Name”, all items in the text library will be sorted in the increasing order by the first letter of the item name.

VEDA HCT User Manual

4.7.2.4 Display All Languages

After checking the button “Display All Language”, all the languages will display in the table including which is not checked in the “language display” window.

4.7.2.5 A~Z letters

The A~Z letters are used to locate the desired item.

4.7.2.6 Preview box

The same content to the selected text in the table displays simultaneously in the preview box. If you modify the content in the preview box, the selected text in the table will be modified to the same content.

Note:

The name of the item is not displayed in the preview box.

Test		
Name	Status Number	Reference Number
Example_1	1	0
Status 1-English (United States) 2-Chinese (Simplified, PRC)		
0	Test	测试

The item in the table is shown as below.

Name	Status Number	Reference Number
Example_1	2	0
Status 1-English (United States) 2-Chinese (Simplified, PRC)		
0	Test	测试
1	Act	执行

Note:

The name of the item cannot be blank and not be duplicated.

4.7.2.7 New

A new item will be created after you click the button “New”.

4.7.2.8 Delete

The selected item will be deleted after you click the button “Delete”.

VEDA HCT User Manual

4.7.3 Address Tag Library

The “Address Tag Library” saves the addresses in the tag form. This makes it easy to use and modify the address for the user.

The Address Tag Library can be opened by clicking the menu command “Library/ Address Label Library” or double-click the “Library/ Address Tag Library” in the project tree.

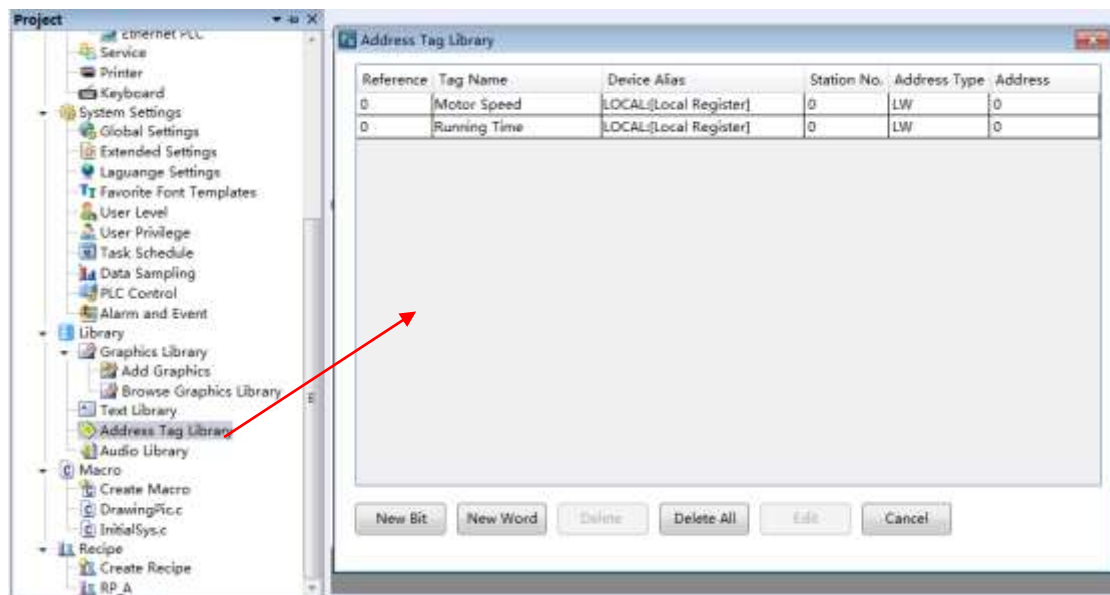

4.7.3.1 Table preview

The table in the “Address Tag Library” displays the information of all the address tags.

Reference	Tag Name	Device Alias	Station No.	Address Type	Address
0	Motor Speed	LOCAL[Local Register]	0	LW	0
0	Running Time	LOCAL[Local Register]	0	LW	0

VEDA HCT User Manual

4.7.3.2 New Bit

After click the button “New Bit”, the “Create Bit Address” dialog will pop up. You can create a new bit address here. The details to input the bit address are referred to: [Detailed manual/General functions/Address editor/Standard Bit Address Input](#).

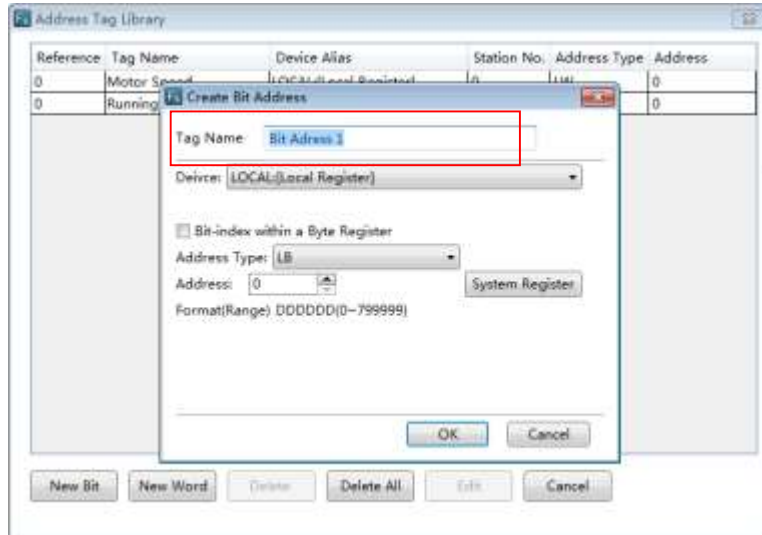

4.7.3.3 New Word

After click the button “New Word”, the “Create Byte Address” dialog will pop up. You can create a new word address here. The details to input the bit address are referred to: [Detailed manual/General functions/Address editor/Standard ByteAddress Input](#).

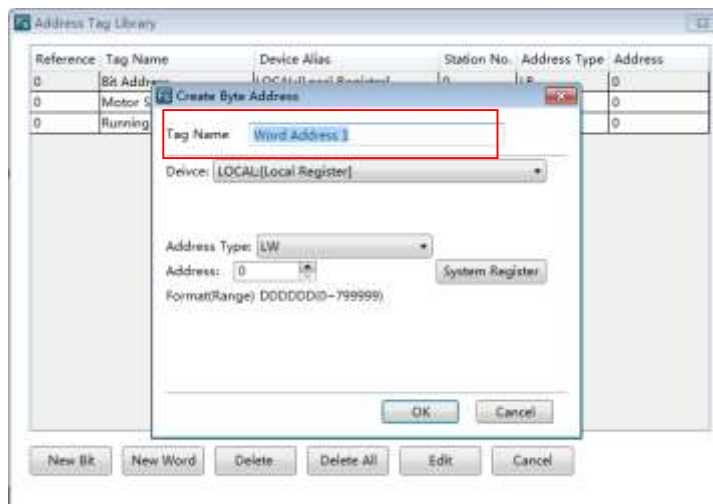

4.7.3.4 Delete

Delete the selected tag.

4.7.3.5 Delete All

VEDA HCT User Manual

Delete all tags.

4.7.3.6 Edit

Modify the selected tag.

4.7.4 Audio Library

In the VEDA HCT software, you can use some specific audios. These audios can be selected from the Audio Library or be added from the other devices.

The Audio Library can be opened by clicking the menu command “Library/ Audio Library” or double-click the “Library/ Audio Library” in the project tree.

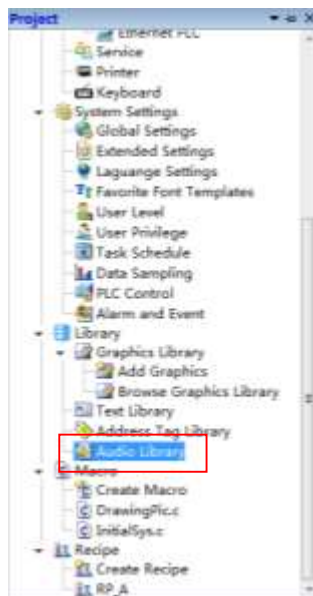
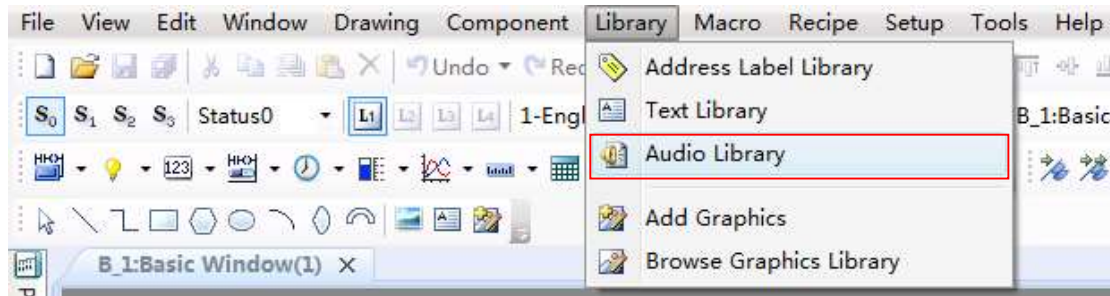

The “Audio Library” is opened as below.

VEDA HCT User Manual

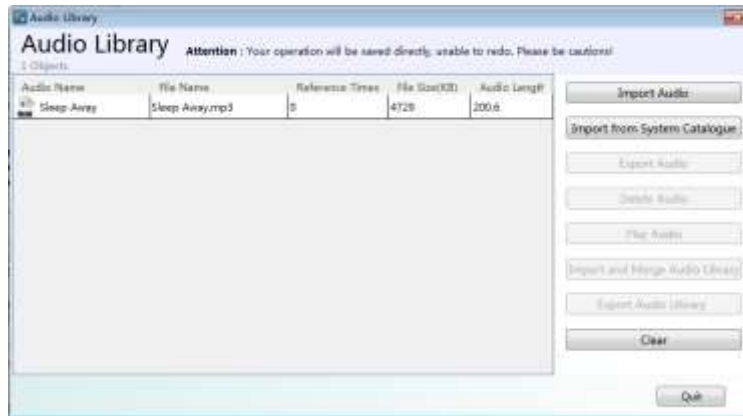

4.7.4.1 Import Audio

After click the button “Import Audio” or “Import from System Catalogue”, the audio file in the current computer can be imported to the Audio Library.

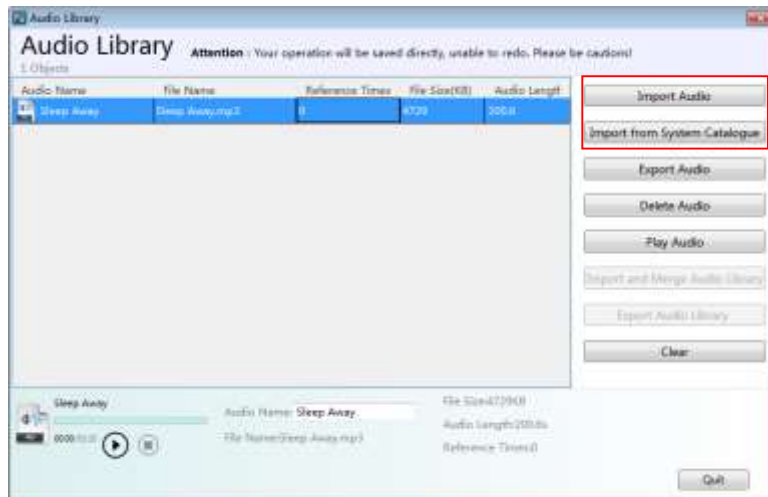

4.7.4.2 Export Audio

You can click the button “Export Audio” to export the selected audio. So the other projects can use it.

VEDA HCT User Manual

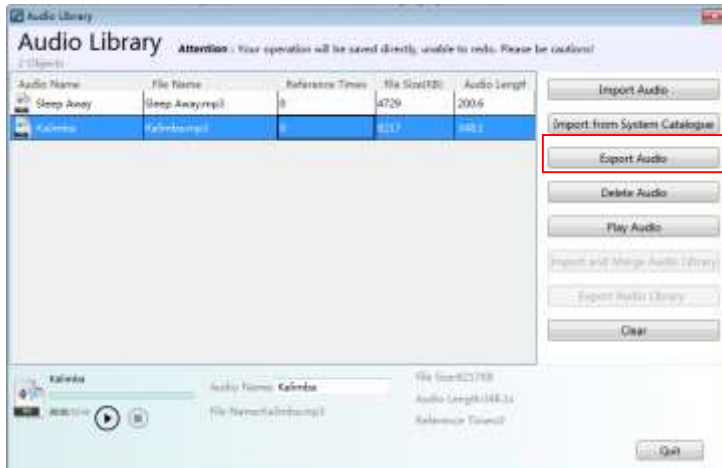

4.7.4.3 Play Audio

After you import the audio to the Audio Library and select it, you can click the button “Play Audio” to listen.

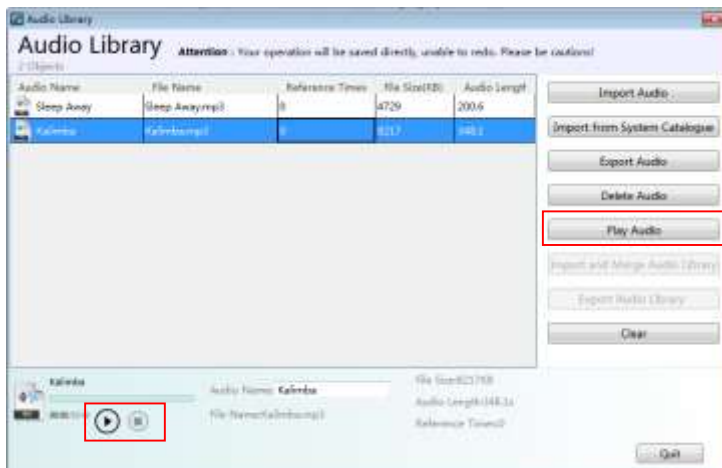

4.7.4.4 “Delete Audio” and “Clear”

You can delete the selected audio by clicking the button “Delete Audio”. And you can delete all the audios of the Audio Library by clicking the button “Clear”.

VEDA HCT User Manual

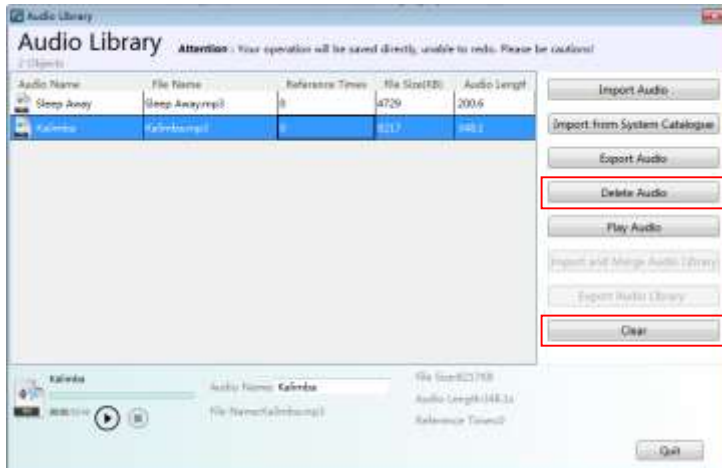

4.7.4.5 Name

You can change the name of the imported audio in the edit box “Audio Name” for your project.

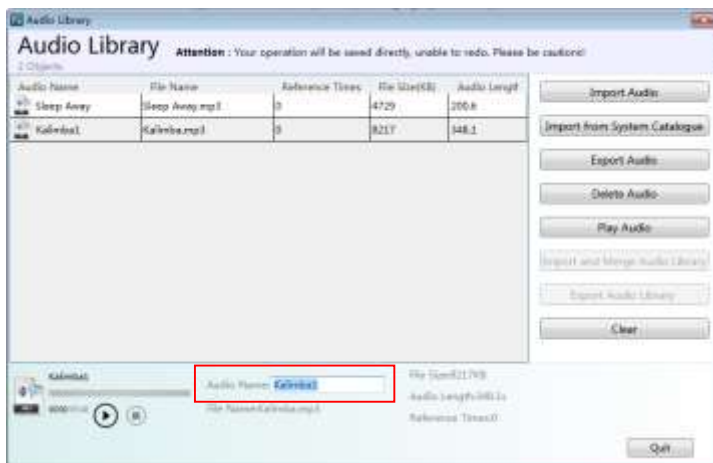

4.7.5 Watch Address Table

“Insert Watch Address” button will be used in the alarm content display of the “Alarm and Event Detail Setting”. You can set the “Watch Address Table” in the following ways.

VEDA HCT User Manual

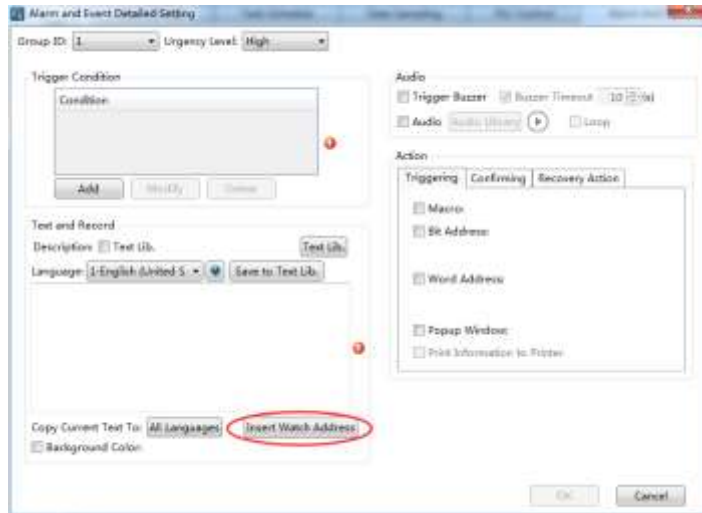

You can click the button as shown in the figure to enter the "Watch Address Table" (path : Alarm and Event Display/Alarm and Events Login/Create/Insert Watch Address), you can also enter it through the tool bar(path: Library /Watch Address Table) .

The "Watch Address Table" page is shown as below:

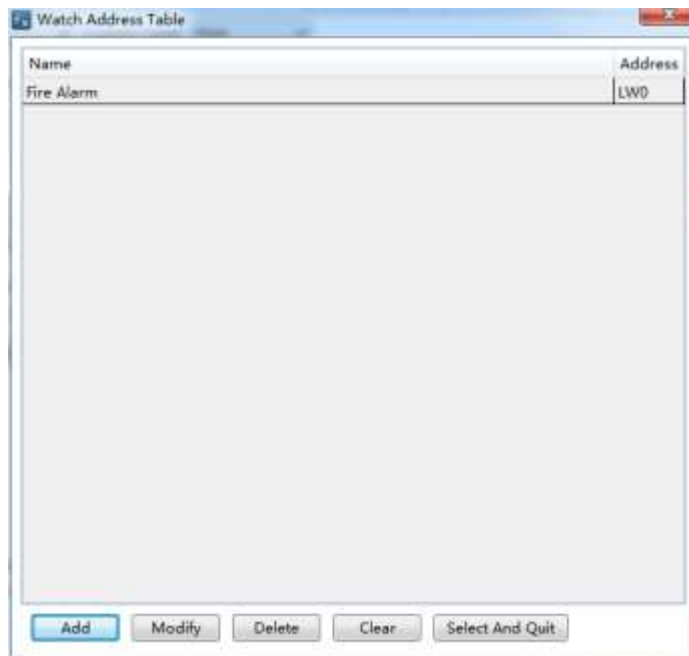

Add: You can add new watch address entry. Click "Add", set the watch address name, such as "Fire Alarm", and set the address of the watch entry, such as "local

VEDA HCT User Manual

register LW0", set the data format, there are various data types to choose; click "Confirm" after setting finished, you can see the figure as below.

Modify: You can modify the created watch address entry.

Delete: You can delete the selected watch address entry.

Clear: You can delete all watch address entries.

Select and Quit : When you enter the "Watch Address Table" from the "Alarm and Event Detailed Setting" page, select the watch address entry you are using, click the "Select and Quit" button to complete setting.

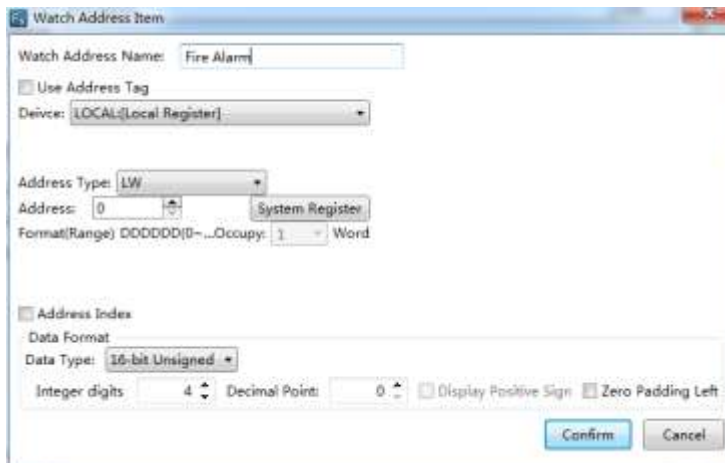

4.7.6 Device Tag Library

The "Device Tag Library" saves the device addresses in the tag form. This makes it easy for the users to use and modify the addresses .

You need add the contents of the tag first when using the devices of tag type. The added tag should be the tags on the tag type devices.

VEDA HCT User Manual

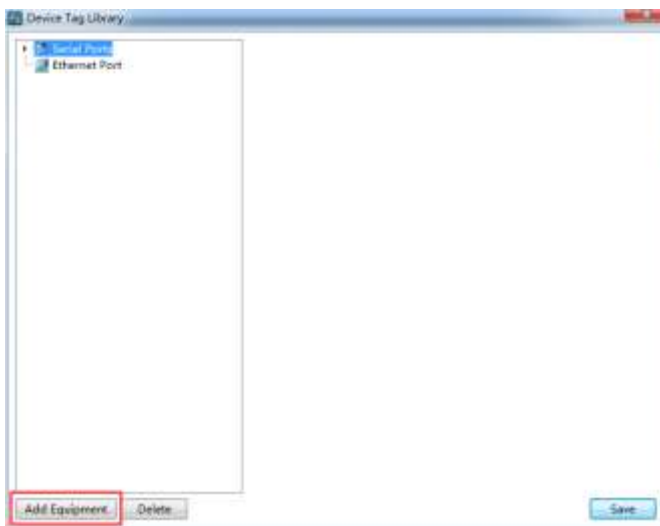
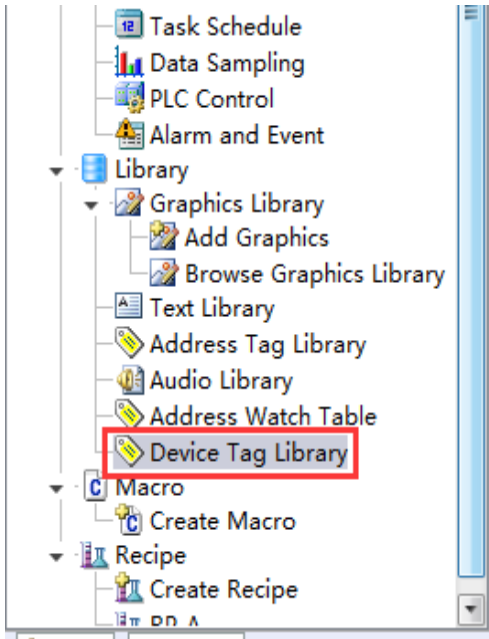

Add Equipment: Click the “Add Equipment” button, select the “Serial Port Type”, and select the “Manufacturer” and “Device Type”. Then click “OK” to finish adding after selecting device, the added device should be the tag type device here, such as the figure shown as below.

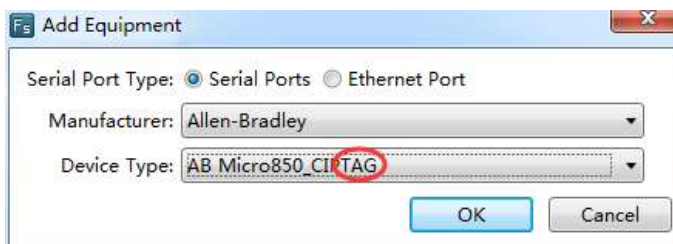

VEDA HCT User Manual

Add Tags

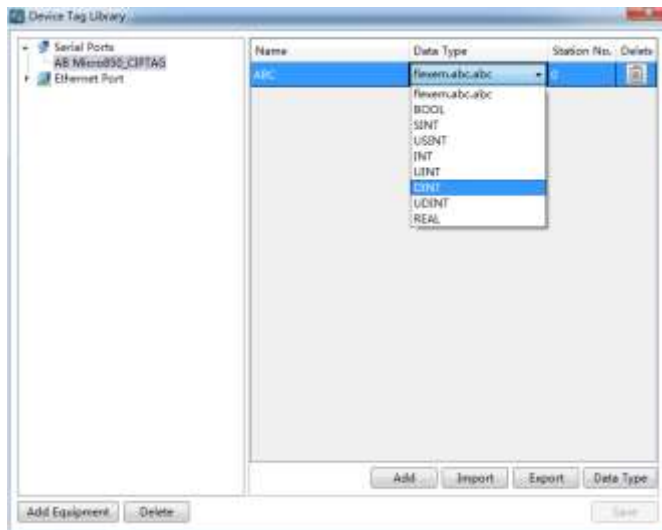
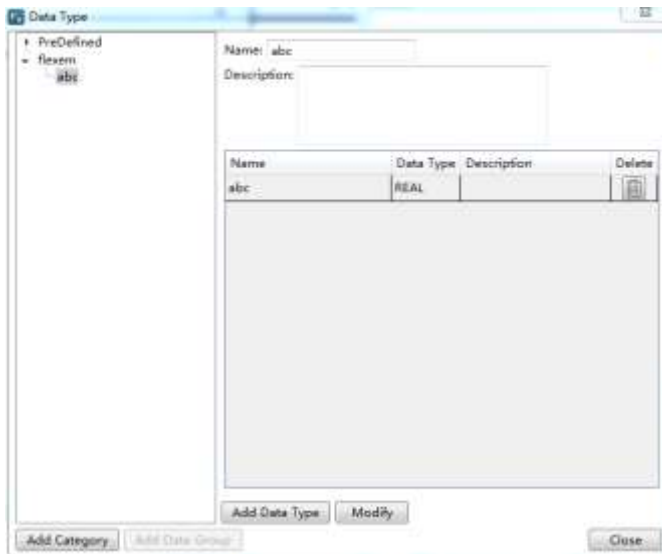

Add: You can add tags manually, enter the tag name, select the data type and station number, click "Save" after finishing adding.

Import: You can import the tags directly in the form of file, this will facilitate users to quickly establish a tag library. the tag file format can be imported is CSV file. The CSV format files can be exported by the tag type PLC software, you can also make it with Excel, About the table format, you can refer to "Export the CSV File".

Export: You can export the added contents of the tag library as CSV format files, which you can quickly import to other devices to use.

Data type: You can classify and group the data type of the device tags, this will facilitate users to quickly select the data type they need. Click the "Data Type" button, click the "Add Category", then you can define the category name, click the "Add Data Group", you can add the elements of the group - data type. Click "Close" after the definition.

VEDA HCT User Manual

After defining the data type, you can see the data type just defined in the "Data Type" page, as shown below: you can select the data type for the "flexem / abc.REAL", the nature of this type is "REAL".

Delete Data Type:

Right-click the data category then you can modify category, delete category, and add data group. Right-click data group then you can delete the data group.

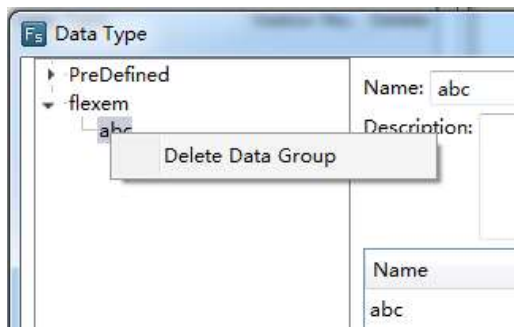
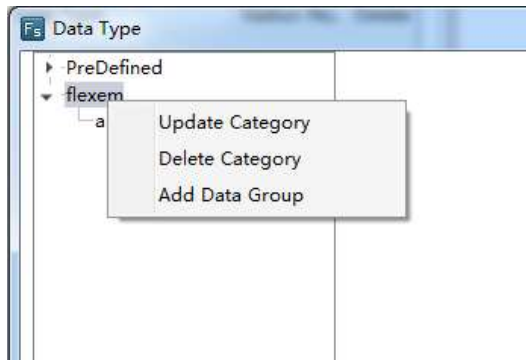

4.8 Macro

4.8.1 Create Macro

Click the menu command "Macro/ Create Macro" or double-click the "Macro/ Create Macro" in the project tree, you can open the "Create Macro" window. It is shown as below.

VEDA HCT User Manual

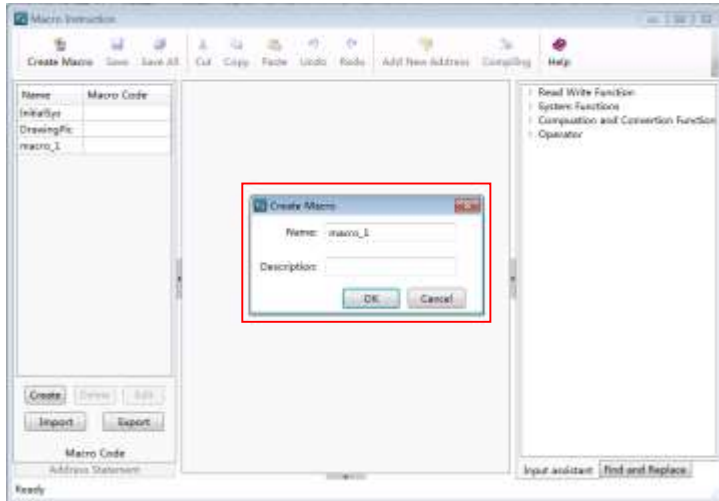

(1)Name

You need to designate a name for the new macro. It will be displayed in the "Macro" directory of the project tree. When you call and execute a macro, the name is used. It can be in Chinese or English.

(2)Description

The "Description" is used to introduce the macro, which is similar to the "Comments". It can be in Chinese or English.

Click the button "OK" to confirm and the new macro will be displayed in the macro editor as below. You can also click the button "Cancel" to cancel the new macro.

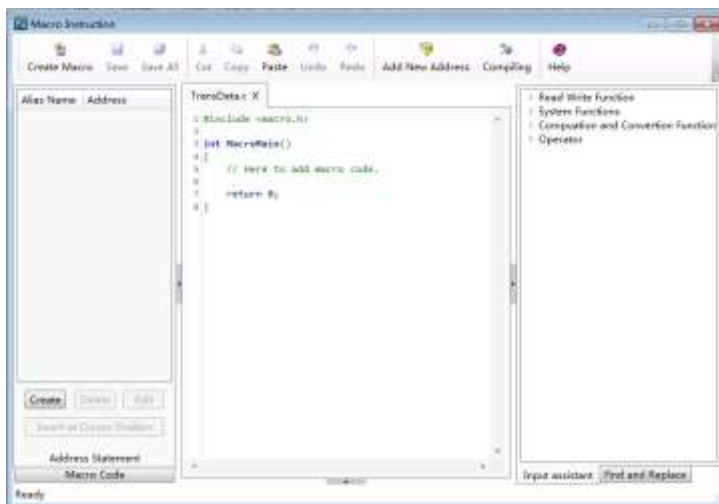

You can edit the macro code in the code editor window. The details are referred to: [Use topic/Macro](#).

4.8.2 Edit Macro

VEDA HCT User Manual

Click the menu command "Macro/ Edit Macro", you can open the "Macro Instruction" window. It is shown as below.

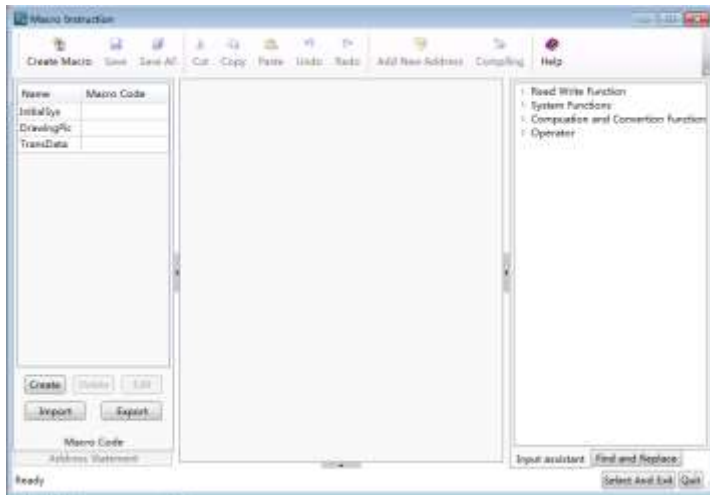

The existing macros are listed on the left side of the "Macro Instruction" window.

After clicking any one of the existing macros, you can delete, modify, import and export it. But the deleted macro will not be recovered.

After double-click any one of the macro, the macro can be opened and display in the code editor window area.

The details are referred to: [Use topic/Macro](#).

4.8.3 Enable Password Verification

You can use the password verification function to protect the macro codes.

Click the menu command "Macro/Enable Password Verification", you can open the "Set Macro Password" window.

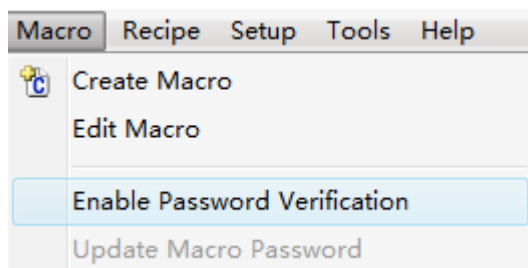

VEDA HCT User Manual

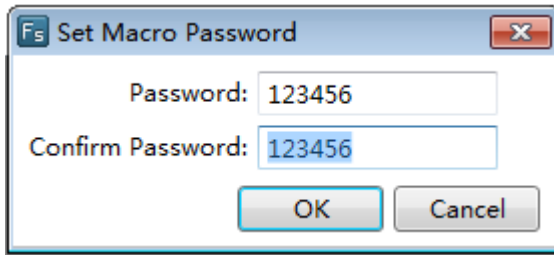

Note the “Confirm Password” needs to be same to the “Password”. Otherwise the “OK” button will be unavailable.

After you enable password verification, the “Verify Password” window will pop up when you click the menu command “Create Macro” or “Edit Macro”. These two menu commands can be use only after you entering the correct password. The “Verify Password” window is shown as below.



If you want to cancel the password verification function, you can click the menu command "Macro/Enable Password verification" again and enter the correct password to cancel the password verification function.

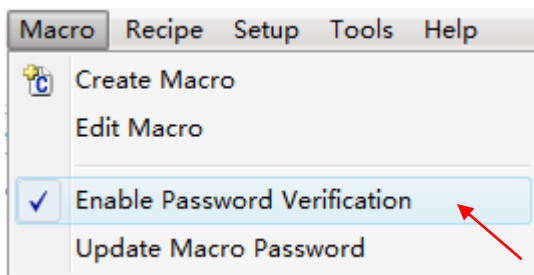

If you want to modify the macro password, the details are referred to: [Detailed manual/Macro/Update MacroPassword.](#)

Note: The macro password is a global password. All macros need to password verification once you enable the password verification function. You can't set a password for a single macro.

4.8.4 Update Macro Password

VEDA HCT User Manual

If you use the “Enable Password Verification” function, the menu command “Update Macro Password” is available. Otherwise this command is not available.

The menu command “Update Macro Password” is available. It is shown as below.

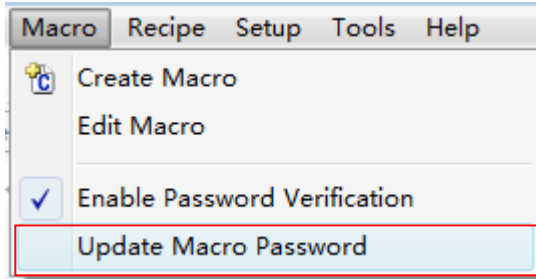

The menu command “Update Macro Password” is not available. It is shown as below.

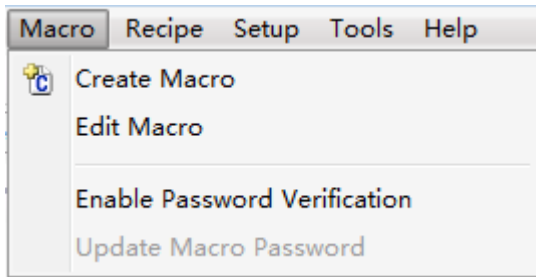

After click the "Update Password Verification", the “Update macro password” window will pop up.

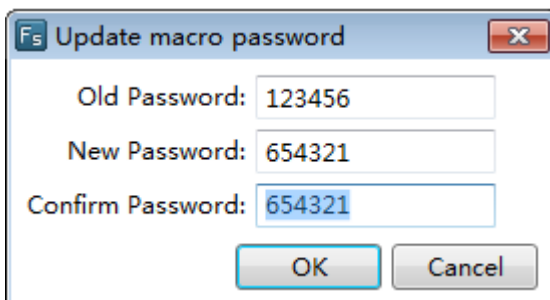

Enter the correct old password and valid new password, then clicking the button “OK” to confirm the password modification.

If the new password is not valid, the button “OK” is unavailable.

After click the button “OK”, a “Warning” window will pop up to message that the old password is error if the old password is not correct.

VEDA HCT User Manual

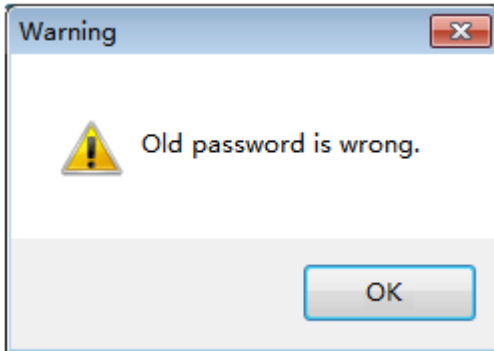

4.9 Recipe

Recipe refers to a group of data saved in a continuous registers of the HMI device. The data in this area is resistant after powering off. It can be quickly downloaded to the controller.

Click the menu command "Recipe/ Create Recipe" or double-click the "Recipe/ Create Recipe" in the project tree, you can open the "Recipe" settings page. It is shown as below.

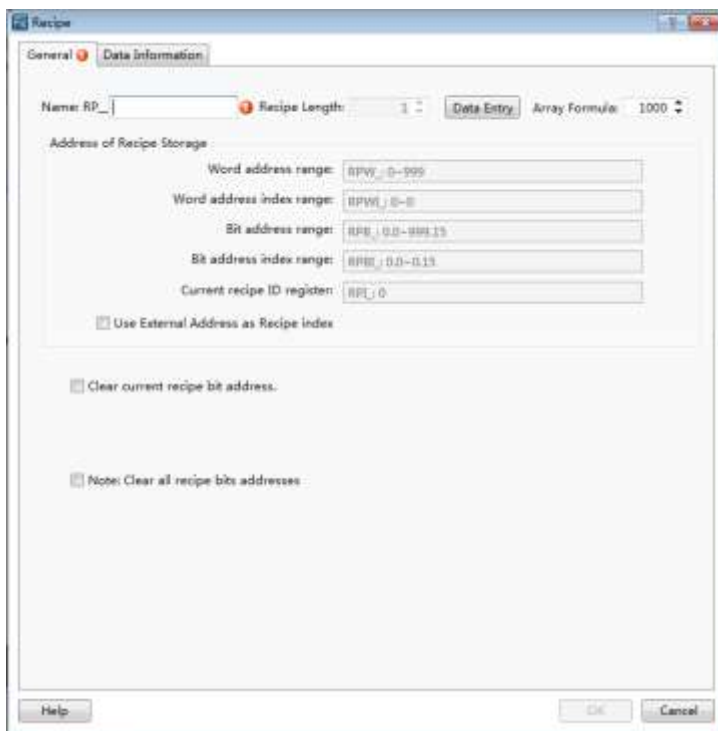

4.9.1 General

4.9.1.1 Name

VEDA HCT User Manual

You need to specify a name for the new recipe for the "Name" option. The name can be English, numbers, letters, and so on. The prefix name "RP_" is fixed and not editable. It represents a "recipe register". For example, if you give a name "coffee" for a recipe, then the whole name of the recipe is "RP_coffee". The recipe word register name is "RPW_coffee".

4.9.1.2 Recipe Length

The default "Recipe Length" is 1. You can modify it by clicking the button "Data Entry" or clicking the title of the settings page "Data Information". The Recipe Length refers to the number of words occupied by each group of this recipe.

4.9.1.3 Array Formula

The default value of the "Array Formula" is 1000. It ranges from 1 to 65535.

The whole length of the word register addresses occupied by the recipe can be calculated after you set the "Recipe Length" and the "Array Formula". For example, if the "Recipe Length" is 10 and the "Array Formula" is 1000, then the whole length of the word register addresses occupied by the recipe is $10 \times 1000 = 10000$.

4.9.1.4 Address of Recipe Storage

You can view the details of the addresses occupied by the recipe in the "Address of Recipe Storage" area. It is shown as below.

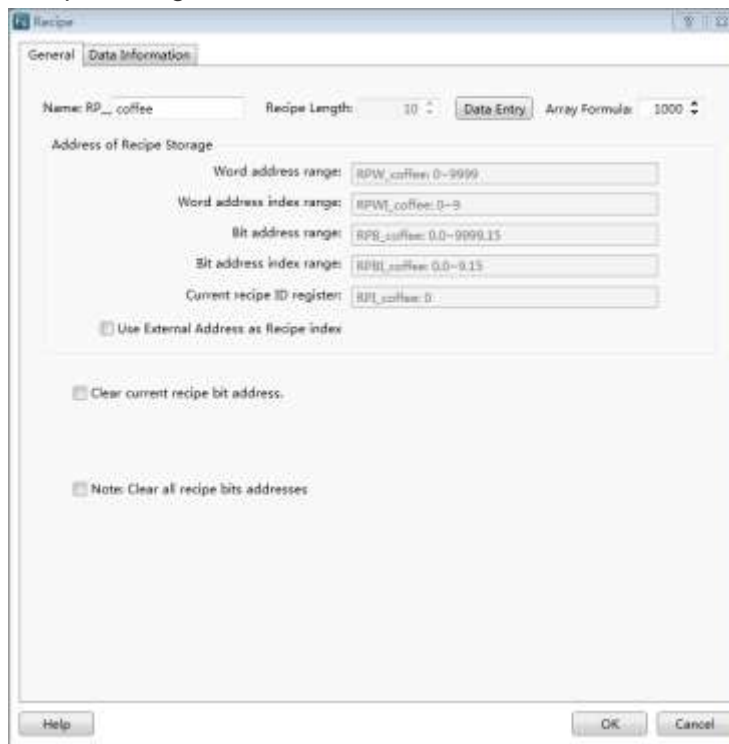

4.9.1.4.1 Word address range

VEDA HCT User Manual

For example, the “Recipe Length” is 10 and the “Array Formula” is 1000, so the whole length of the word register addresses occupied by the recipe is $10 \times 1000 = 10000$. The Recipe name is “RP_Coffee”. So the address range of the word registers is "RPW_Coffee: 0 ~ 9999".

4.9.1.4.2 Word address index range

In the above example, the “Recipe Length” is 10 for each group of the recipe. So the Word address index range is "RPWI_coffee: 0-9."

4.9.1.4.3 Bit address range

The bit address range is determined by the word address range. So the bit address in the above example is "RPB_coffee: 0.0 to 9999.15."

4.9.1.4.4 Bit address index range

Similarly, the bit address index range is determined by the “Recipe Length”. So the “Bit address index range” is "RPBI_coffee: 0.0 to 9.15."

4.9.1.4.5 Current recipe ID register

The “Current recipe ID register” is used to specify the group number of the recipe. For the above example, the “Current recipe ID register” is “RPI_coffee: 0”. It is a unique register for each recipe.

4.9.1.4.6 Use External Address as Recipe index

It is not checked by default. If it is checked, you can specify a word address as a recipe ID register and the "Current recipe ID register" (such as "RPI_Coffee: 0") is not valid.

4.9.1.5 Clear current recipe bit address

It is not checked by default. If it is checked, you can specify a bit address. If it is set ON, the current data of the recipe group which specified by the recipe ID register will be cleared. After the data is cleared, this bit address will be reset OFF. It is shown as below.

VEDA HCT User Manual

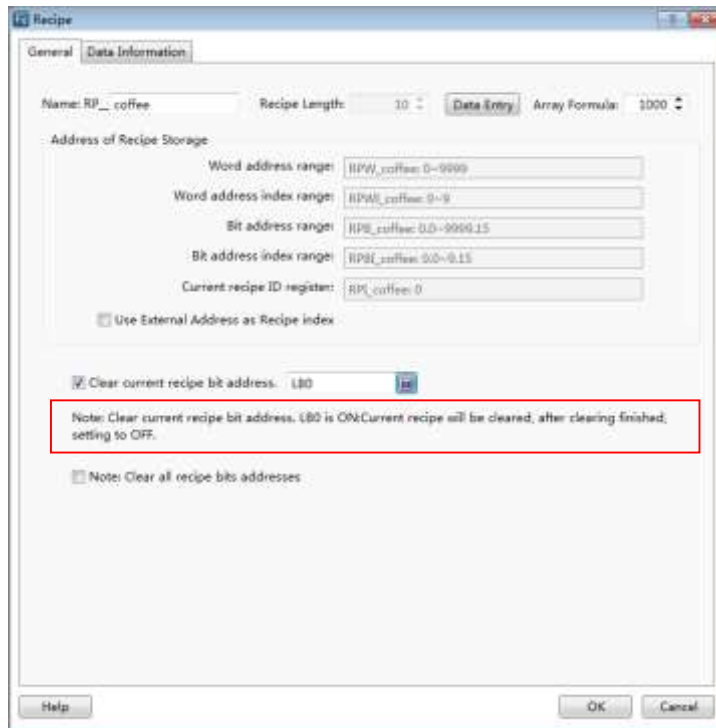

For example, if the value of the "RPI_coffee: 0" register is 3, the data of the No. 3 group of the recipe "RP_coffee" will be cleared when the "Clear current recipe bit address" LB0 is set ON. After finish clearing, LB0 will be reset OFF.

4.9.1.6 Note: Clear all recipe bit addresses

It is not checked by default. If it is checked, you can specify a bit address. If it is set ON, the data of all the recipe groups will be cleared. After the data is cleared, this bit address will be reset OFF. It is shown as below.

VEDA HCT User Manual

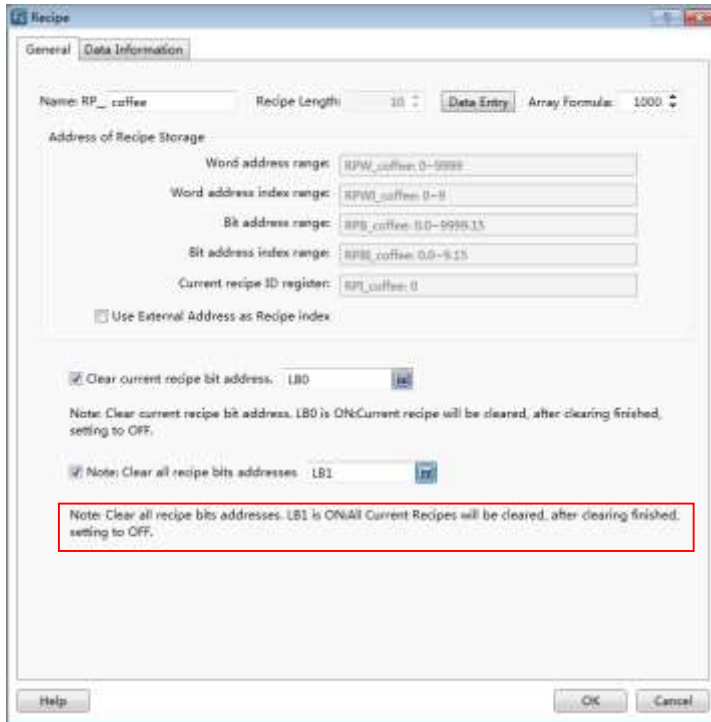

For the above example, all the data of the recipe “RP_coffee” will be cleared if the bit register LB1 is ON. After the data is cleared, LB1 will be reset OFF.

4.9.2 Data Information

The default "Data Information" settings page is shown as below.

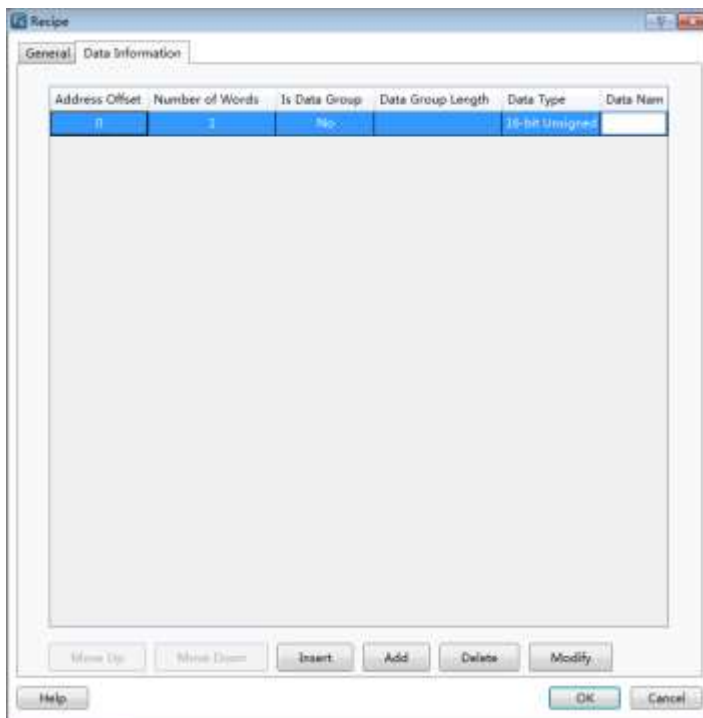

VEDA HCT User Manual

The default recipe length is 1. A 16-bit unsigned data is preset.

4.9.2.1 Modify

After double-click the selected entry, the “Data Setting” dialog will pop up. You can modify the settings for this entry. It is shown as below.

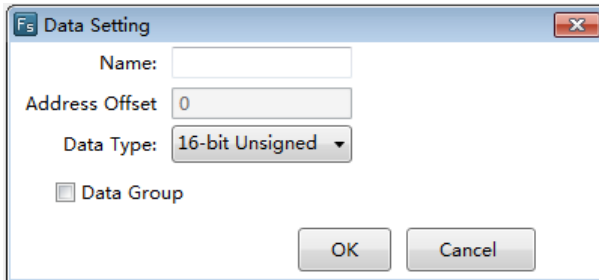

4.9.2.1.1 Name

A description for the data of this entry can be given here.

4.9.2.1.2 Address Offset

It refers to the address offset of this entry in the recipe. The address offset of the first entry starts from 0. It is determined according to the data type and the entry order by system and not be edited.

4.9.2.1.3 Data Type

A data type needs to be set here. The default is "16-bit Unsigned".

4.9.2.1.4 Data Group

It is not checked by default. You can check it when you need to define a group of the same data type data for this entry.

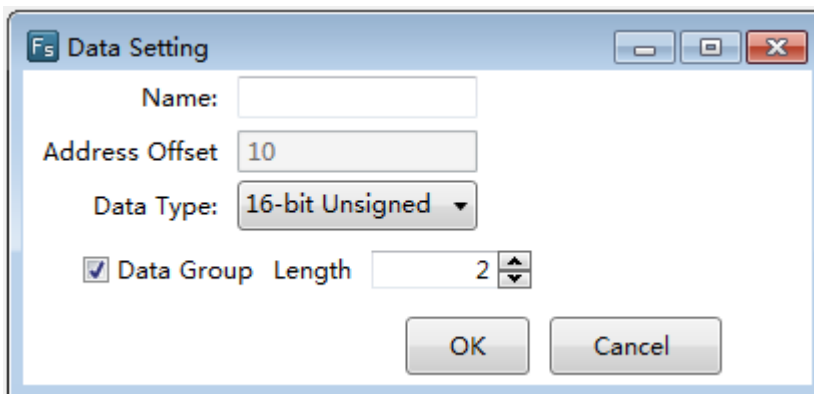

VEDA HCT User Manual

The "Length" option needs to set for the data group when you check the option "Data Group".

Click the button "OK" to finish the settings for the selected entry.

4.9.2.2 Insert

After select an entry in the list and then click the button "Insert", a new entry will be added before the selected entry.

4.9.2.3 Add

After click the button "Add", a new data entry will be added after the last data entry.

4.9.2.4 Move Up

For many data entry, the selected data entry will be moved up a row after click the button "Move Up".

4.9.2.5 Move Down

For many data entry, the selected data entry will be moved down a row after click the button "Move Down".

4.9.2.6 Delete

The selected data entry will be deleted from the list after click the button "Delete".

For example, the recipe "RP_coffee" has only one entry and the data type of the entry is "16-bit Unsigned". The Recipe Length is 10. The data setting of the entry is shown as below.

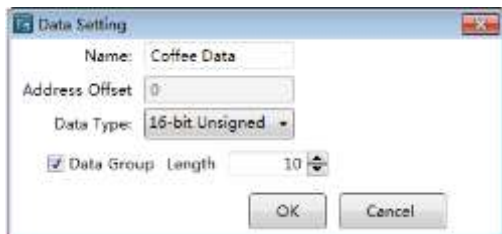

After click the button "OK" to confirm the entry setting, the "Data Information" setting page of this recipe is shown as below.

VEDA HCT User Manual

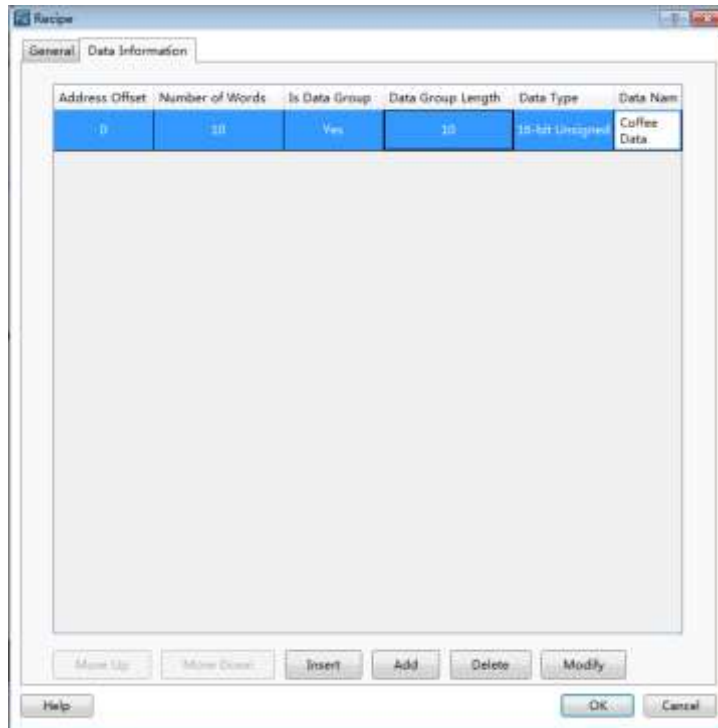

Thus, a named "RP_coffee" recipe is created. It will be displayed in the project tree. It is shown as below.

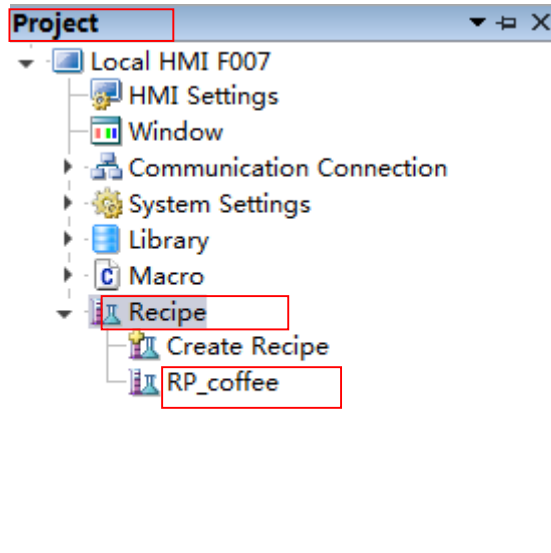

4.10 Setup

4.10.1 HMI settings

You can open the "HMI Settings" property TAB by clicking the menu command "Setup/ HMI Settings ". It is shown as below.

VEDA HCT User Manual

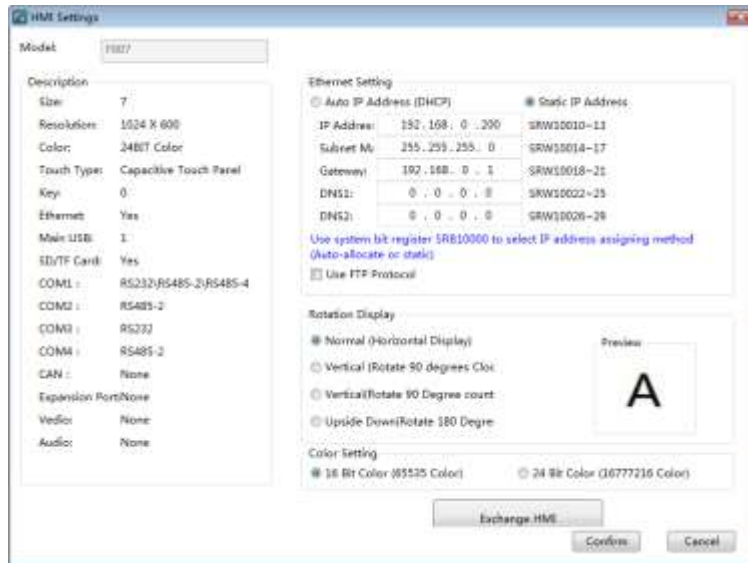

4.10.1.1 Model

The “Model” displays the type of the current selected HMI device.

4.10.1.2 Description

The detailed information of the current HMI device is displayed in the “Description” area.

4.10.1.3 Ethernet setting

You can set the Ethernet connection properties for the current HMI device. The setting mode of IP address can be “Auto IP Address (DHCP)” or “Static Address”.

If you select a “Static Address” mode, the IP address can be assigned here. Or you can use the SRW registers to set the IP address.

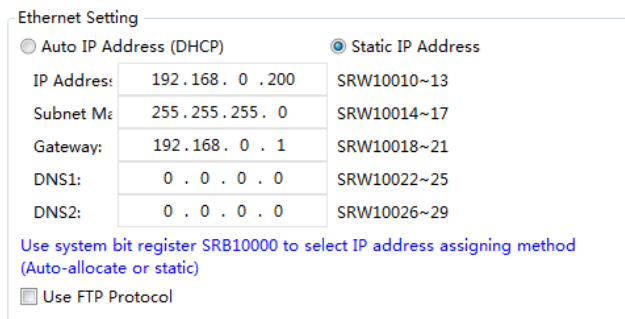

VEDA HCT User Manual

When SRB10000=0, the setting mode is DHCP. When SRB10000=1, the “Static Address” mode is used to assign the IP address. You can switch the IP address setting mode by the SRB10000 register.

4.10.1.4 Rotation Display



There are 4 rotation display effect. They are “Normal (Horizontal Display)”, Vertical (Rotate 90 degrees Clockwise), “Vertical (counterclockwise)” and “Upside down (Rotate 180 degrees)”. You can preview the display effect of the character “A” on the right area.

The rotation display mode should be selected according to the installation direction of the HMI device.

4.10.1.5 Color Setting

You can select “16 Bit Color (65535 Color)” or “24 Bit Color (16777216 Color)” based on your project. This setting will take effect after restarting.

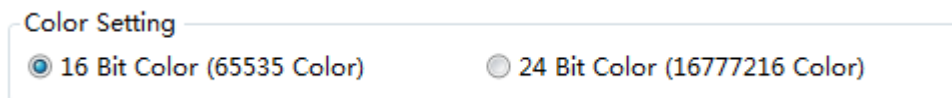

4.10.1.6 Exchange HMI

If you want to change the HMI device type for your project, you can click the button “Exchange HMI”.

VEDA HCT User Manual

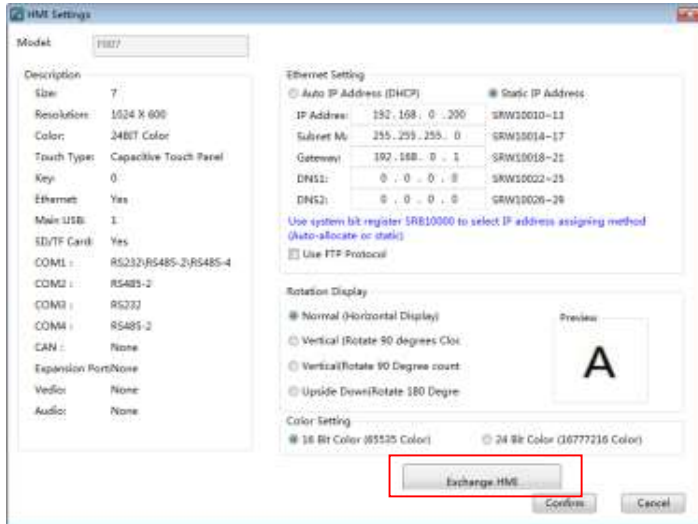

The “Change HMI Model” dialog will pop up after you click the button “Exchange HMI”.

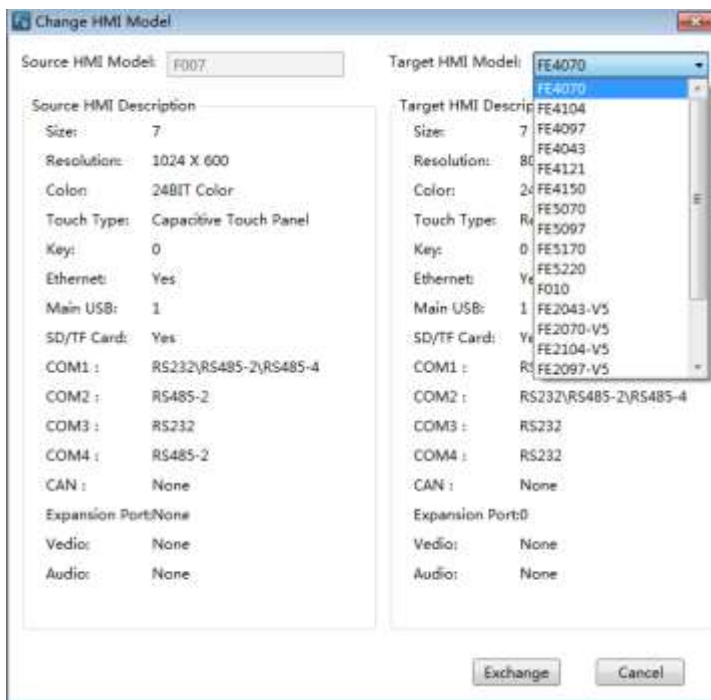

After you select the “Target HMI Model” for your project and click the button “Exchange” to confirm the setting, the project will be converted to adapt the new HMI device.

The resolution and color need to be adjusted by manual after the exchanging operation. Because the resolution and color change may result in the change of the window size and the loss of color.

4.10.2 System Settings

VEDA HCT User Manual

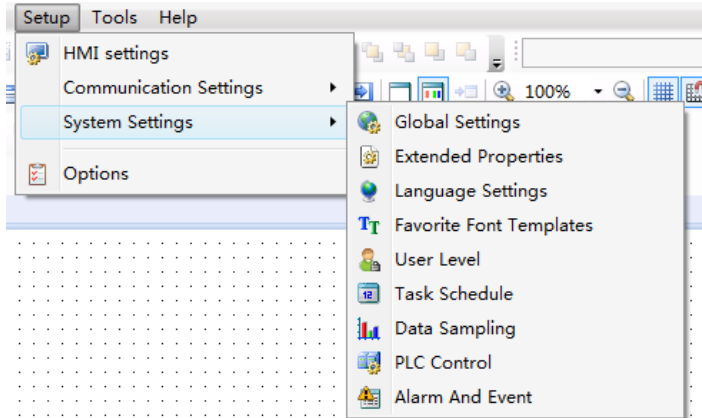

4.10.2.1 Global Settings

You can set the project properties, backlight and screensaver, initialization, the main window, touch audio and other related attributes in the “Global Settings” property TAB.

Click the menu command "Setup/ System Settings/Global Settings" to open the “Global Settings” property TAB. It is shown as below.

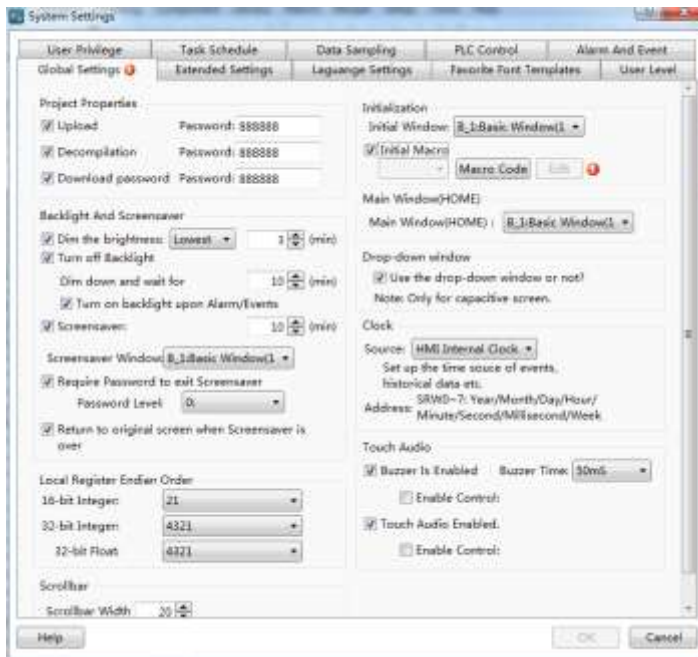

4.10.2.1.1 Project Properties

- Upload

If you check “Upload” and set the “Password”, the project can be allowed to upload when the other user enter the password after it is downloaded to the HMI device. The

VEDA HCT User Manual

uploaded project file can be downloaded to the other HMI device by using the VEDA HCT software Tools.

Note:

The uploaded project file is a special archive. The project can be opened after decompilation by the VEDA HCT software.

- Decompilation

If you check “Decompilation” and set the “Password”, the project can be allowed to decompile by the VEDA HCT Tools after the password is entered.

Note:

- If only the “Decompilation” is checked, the Fpg file of this project can be decompiled after entering the correct password. But this project can't be uploaded.
- If only the “Upload” is checked, this project can be uploaded after enter the correct password. But the Fpg file of this project can't be decompiled.
- If the “Upload” and the “Decompilation” are not checked, the size of the file after compiling is the least. But it cannot be uploaded or decompiled. On the other hand, it is safest way to protect your project.

- Download Password

The HMI projects can be downloaded if the option is not checked. After checking the option, then you need to enter the password every time you want to download projects from the HMI, to avoid the original projects to be replaced.

4.10.2.1.2 Backlight and Screensaver

- Dim the brightness

You can check the option “Dim the brightness” to adjust the backlight lightness after the specified time. The lightness can be set “Lowest”, “10%”, “20%”, “30%”, “50%” or “80%”. The specified time needs to input in integer.

VEDA HCT User Manual

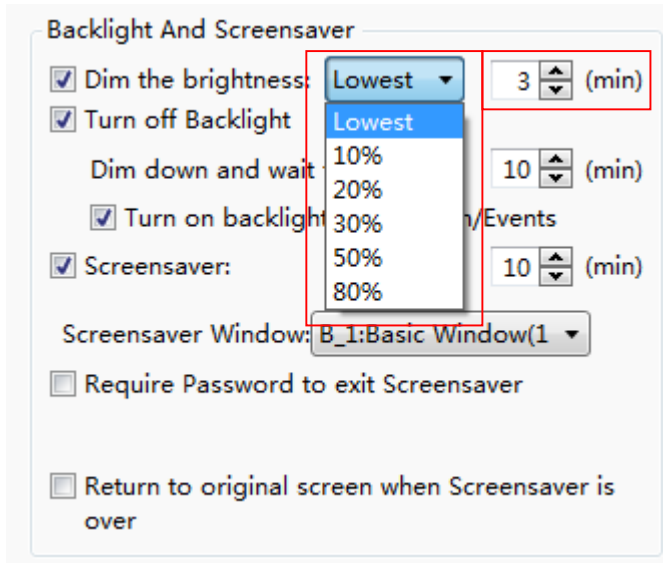

- Turn off Backlight
- Dim down and wait for

You can set a specified time to turn off the backlight after the lightness is adjusted. The default value is 10. That means it will keep 10 minutes after the backlight lightness is adjusted. Then the backlight will be turned off.

Note:

The configuration screen will be visible after the backlight is turned off.

- Turn on backlight upon Alarm/Events

If you check the option "Turn on backlight upon Alarm/Events", the backlight will be turned on automatically when the alarms or events occur and the backlight is off during the running.

- Screensaver

If you check the option "Screensaver", the Screen saver Window will be switched to display when the time is up. The Screen saver Window must be specified. It is used to display the company LOGO.

- Require Password to exit Screensaver

If you check the option "Require Password to exit Screensaver", a system message window will pop up to prompt you to enter the corresponding level password when you want to exit the screen saver window.

VEDA HCT User Manual

Note:

You need to use the character input component to enter the password to SRW100 ~ 103.

- Return to original screen when Screensavers is over

If you check the option “Return to original screen when Screensavers is over”, it will return to the original screen when you click the HMI screen. Of course, if you set a password, the system message window will pop up to prompt you to enter the password before return to the original screen.

Note:

If you don't check the option “Return to original screen when Screensavers is over”, it will still stay in the screensaver window when the screensaver is over.

4.10.2.1.3 Local Register Endian Order

The “Local Register Endian Order” refers to the order of the high byte and the low byte. For example, a 32-bit register LW0=0x12345678. If you select the “4321” mode, then the word register LW0=0x1234 and the word register LW1=0x5678. If you select the “2143” mode, then the word register LW0=0x5678 and the word register LW1=0x1234.

4.10.2.1.4 Scrollbar

For some components without setting the scrollbar width, you can set it in the “Scrollbar Width” option. For example, you set the scrollbar width for the pop up window component here.

4.10.2.1.5 Initialization

- Initial Window

The “Initial Window” refers to the first displayed configuration window after the project is downloaded to the HMI or the HMI is powered on.

- Initial Macro

After check the “Initial Macro”, you can specify a Macro to run before the configuration window is displayed. This function can realize the initial work of your project.

4.10.2.1.6 Main Window(HOME)

VEDA HCT User Manual

The main window can be set here. So you can return to the main window in any configuration window by setting “Return to the main window (HOME)” for the “Window Operation” function of the Bit Set component.

4.10.2.1.7 Drop-down window

If this function is checked, you can specify a window as a pull-down window, where you can put the alarm events and other related components to display. This function is valid only for the capacitive HMI device.

Note:

When you slide the HMI window to more than half the width of the window from the upper edge down during running the project, the Drop-down window will display gradually. Similarly, when you slide to more than half the width of the window from the lower edge up, the Drop-down window will be withdrawn.

4.10.2.1.8 Clock

The “Source” of Clock can be set “HMI Internal Clock” or “External Device”.

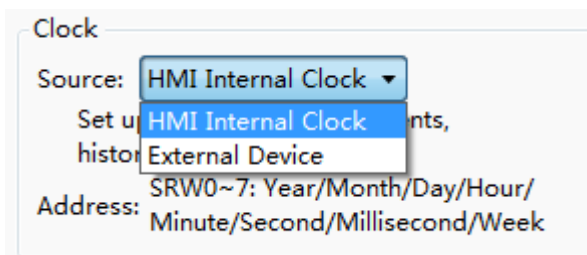

If you select the “HMI Internal Clock” as the HMI clock, SRW0~7 will be used to save the time source of events, historical data, etc.

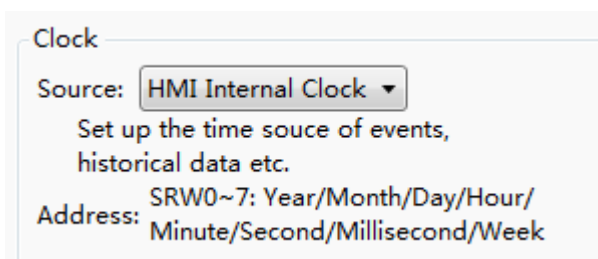

If you select the “External Device”, the registers address can be changed.

VEDA HCT User Manual

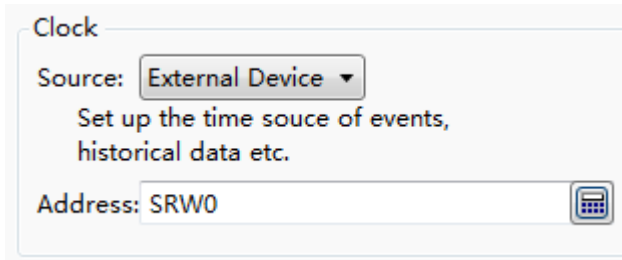

4.10.2.1.9 Touch Audio

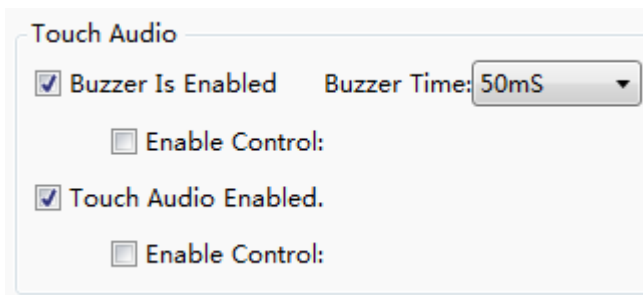

- Buzzer is enabled

If only the option “Buzzer Is Enabled” is checked, the buzzer will beep for a specified time when you touch the effective components, such as buttons.

If the option “Enable Control” is also checked, you need to select a bit register. When the bit register is ON, the function of “Buzzer Is Enabled” is allowed to use. For example, the LB0 is set for the “Enable Control”. If LB0 is ON, the buzzer will beep when you touch the effective components. When it is OFF, the buzzer will not beep. The option “Buzzer Time” can set 50ms, 75ms, 100ms, 150ms, 200ms, 300ms, 500ms, 800ms, and 1s.

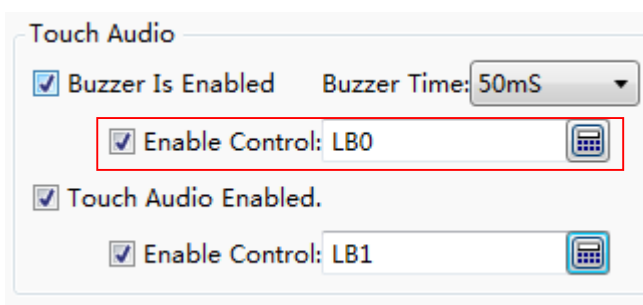

- Touch Audio Enabled

If the option “Touch Audio Enabled” is checked, all audio play is available. It is selected by default.

VEDA HCT User Manual

If the option “Enable Control” is also checked, you need to select a bit register. When the bit register is ON, the function of “Touch Audio Enabled” is allowed to use. For example, the LB1 is set for the “Enable Control”. If LB1 is ON, the audio play is available. If it is OFF, the audio will not be available.

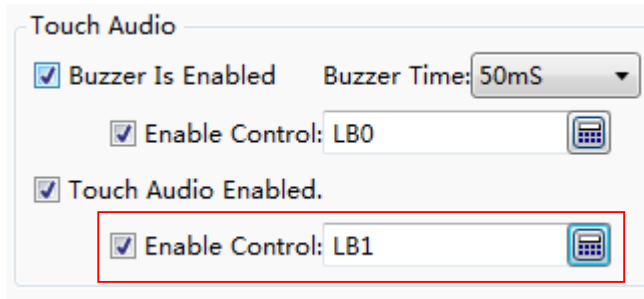

Note:

If the option “Touch Audio Enabled” is not checked in the global settings, the audio will not be available even if the audio is active in the proper TAB of the effective component.

4.10.2.2 Extended Settings

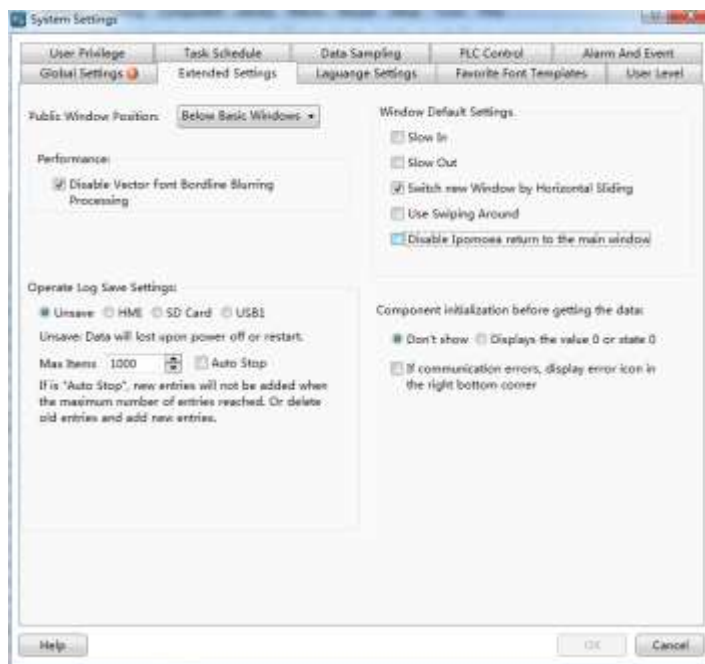

4.10.2.2.1 Public Window Position

The attribute of “Public Window Position” can be set “Below Basic Window” or “Above Basic Window”. The option “Below Basic Window” is selected by default.

VEDA HCT User Manual

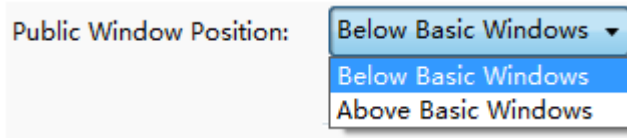

The effect of the “Below Basic Window” is shown as below.



The effect of the “Above Basic Window” is shown as below.



4.10.2.2.2 Performance

If you check the option “Disable Vector Font Bordline Blurring Processing”, the display effect of the fonts will have some burr. It does not look smooth and good, but the display speed is faster. You can use this option to get higher display speed when less display quality is demanded.

Note: the speed difference is not obvious for the hardware which the version is above A8. So you need not check this option generally.

If you don't check the option “Disable Vector Font Bordline Blurring Processing”, the display effect is shown as below.



If you check the option “Disable Vector Font Bordline Blurring Processing”, the display effect is shown as below.

Static Text

4.10.2.2.3 Window Default Settings

There are three options for the “Window Default Settings”. They are “Slow In”, “Slow Out” and “Switch Window by Horizontal Sliding”. The three options are valid only for the capacitive screen.

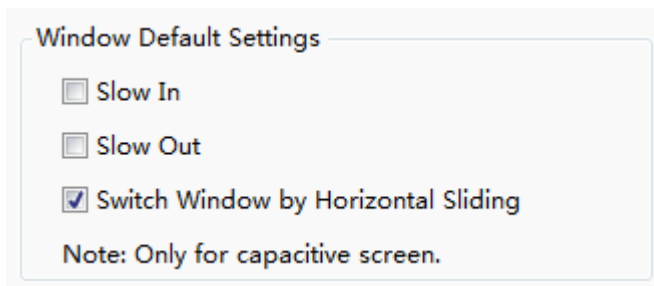

- “Slow In” and “Slow Out”

After the “Slow In” or “Slow Out” is checked, the new window will have a fade effect. You can find the “Fade in” option is checked by default in the “Basic” property TAB of the new window. Another window effect is “Fade out”. The fade effect is only valid for the capacitive HMI device.

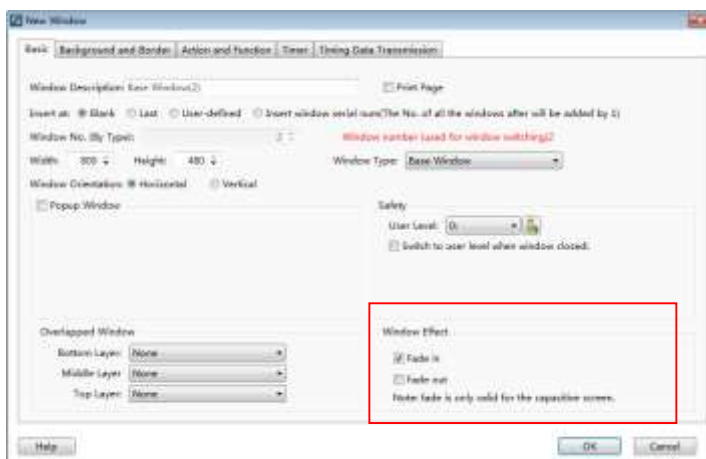

Note:

VEDA HCT User Manual

The fade effect will produce an effect on the speed of switching windows obviously. The economic HMI models are not suggested to be used.

- Switch Window by Horizontal Sliding

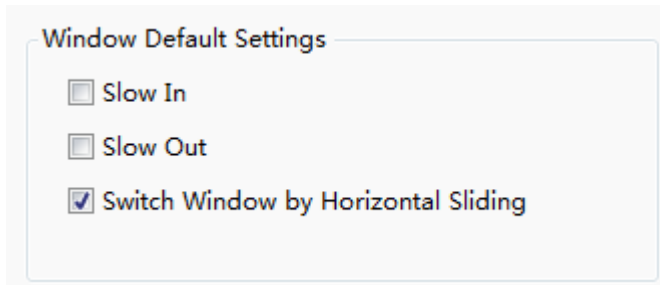

After the “Switch Window by Horizontal Sliding” option is checked, the windows can be switched by horizontal sliding action. This function is only supported by the capacitive HMI devices.

You can set the operation for this function in the “Action and Function” property TAB of the basic window.

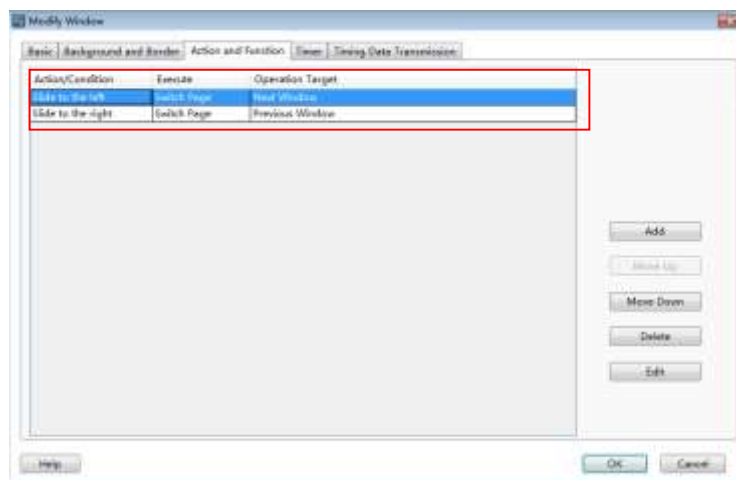

If you click the “Use Swiping Around” option, then the function of horizontal sliding will take effect, the function is only valid for the capacitive HMI.

If you click the “Disable Ipomoea return to the main window” option, then the function of “Ipomoea return to the main window” is disabled, the function is enabled by default, you can check the option if you do not need it. It can be controlled by the special register “SRB10012=1”, too.

Operate Log Save Settings:

VEDA HCT User Manual

Operate Log Save Settings:

Unsave HMI SD Card USB1

Power-off sustain.

Subdirectory Name: LOG

Save CSV File meanwhile

Maximum Saving Limit:(No Limit) 0 Day

On Cache Full: Delete Old Records

When free space is less than: 512KB

Notify Register: LB0

Clear Record Register: LB0

This settings is the global settings, the operating steps can be recorded without setting the operate log control, the default is “unsave”, you can choose to save to the local HMI, SD card, USB1. The address of storing operate log is retained after power down, you can define the subdirectory name by yourself. The files saved is Db files.

Save CSV File meanwhile: The operate log will be saved as Db file and CSV file at the same time. The CSV file can be opened directly and viewed with Excel.

Maximum Saving Limit: there is no limit when it is 0, you can click the option “Delete Old Records” when the cache is full, the new operate log will continue recording, “Discard New Records”, it will not record the operate log any more if the cache is full.

You can set the “Notify Register” when the cache is full, as shown below, LB0 is set to 1 when the free space is less than 512KB.

When free space is less than: 512KB

Notify Register: LB0

You can set a flag bit to clear the historic records of the operate log.

VEDA HCT User Manual

4.10.2.3 Language Settings

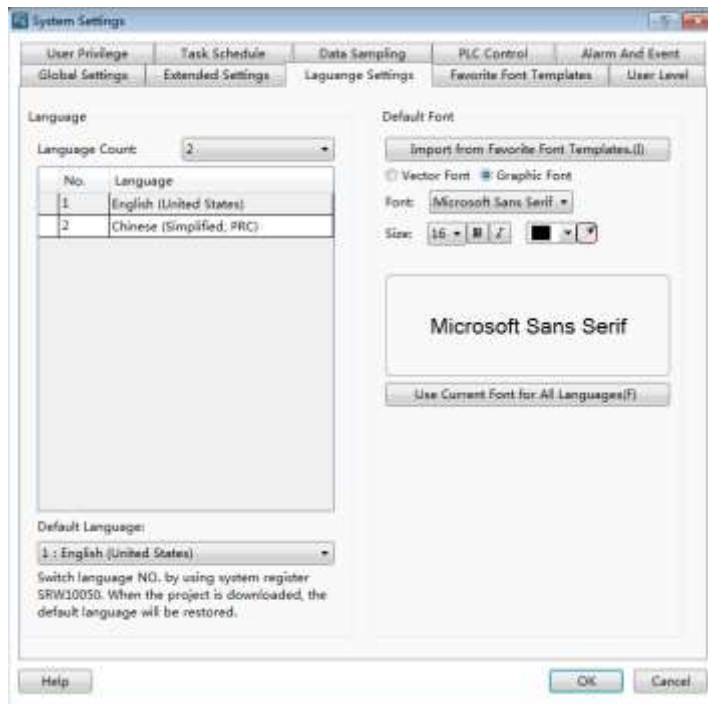

4.10.2.3.1 Language

- Language Count

You can select the number of the languages in the list of the “Language Count” option. Then you set the languages in the table. The languages should be different in the table. You can modify the languages by the lists in the table.

VEDA HCT User Manual

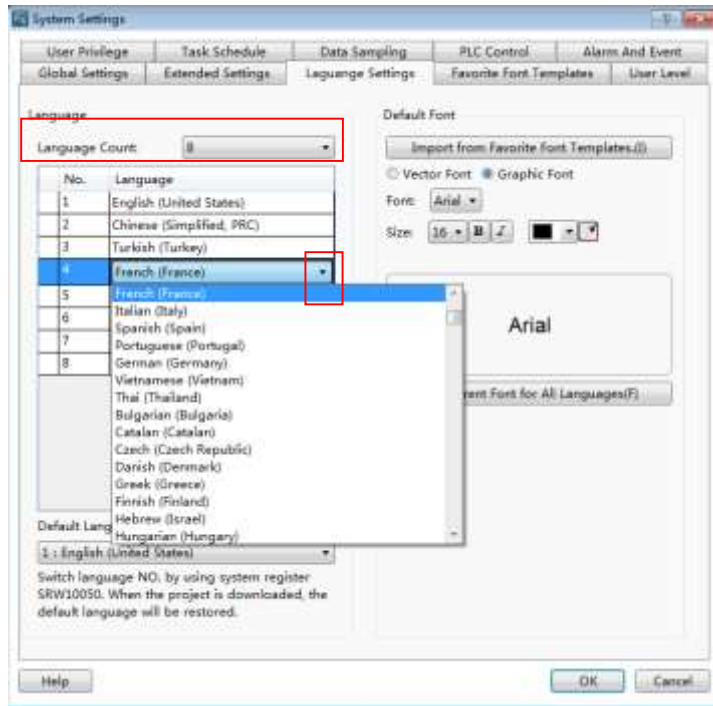

- Default Language

You can select a language from the list as the “Default Language”. After downloading the project, the specified default language will be as the display language. You can switch the display language by changing the value of SRW10050. The No.1 language will be displayed when SRW10050 is 0. The No.2 language will be displayed when SRW10050 is 1. The No.3 language will be displayed when SRW10050 is 2. And so on. The display language will be changed to the specified “Default Language” when the project is downloaded again.

4.10.2.3.2 Default Font

Refer to: [Detailed manual/ General functions/ Drawing/ Font settings.](#)

4.10.2.4 Favorite Font Templates

The function is used to save the common font styles as a template. You can use this template when you set the font style.

4.10.2.4.1 Open the “Favorite Font Templates”

You can open the “Favorite Font Templates” settings page in the project tree or by clicking the menu command “Setup/System Settings/Favorite Font Templates”.

VEDA HCT User Manual

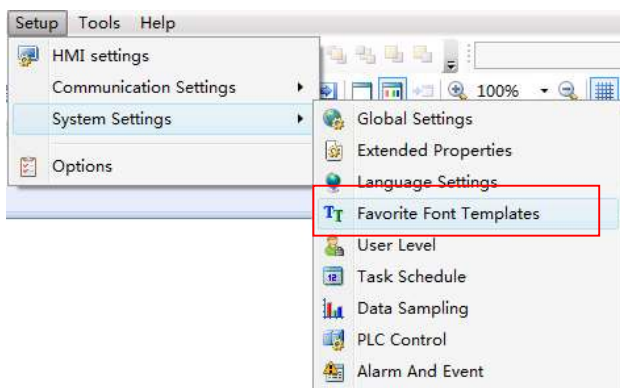
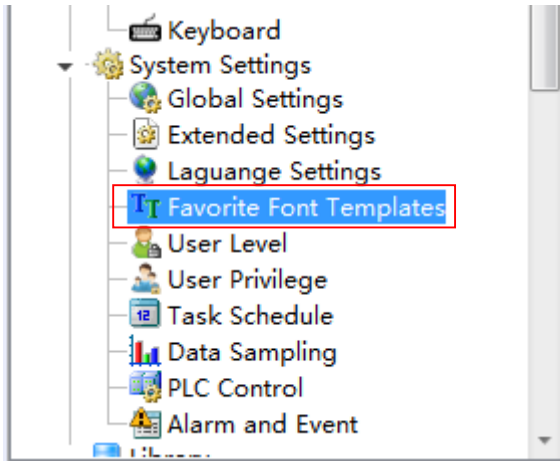

4.10.2.4.2 Add Font Templates

First, click the button "Add(A)". Then give a name for the current font template in the "Description". The font style need to be set, referred to: [Detailed manual/General functions/Drawing/Font settings](#). At last, click the button "OK" to confirm and save the settings

VEDA HCT User Manual

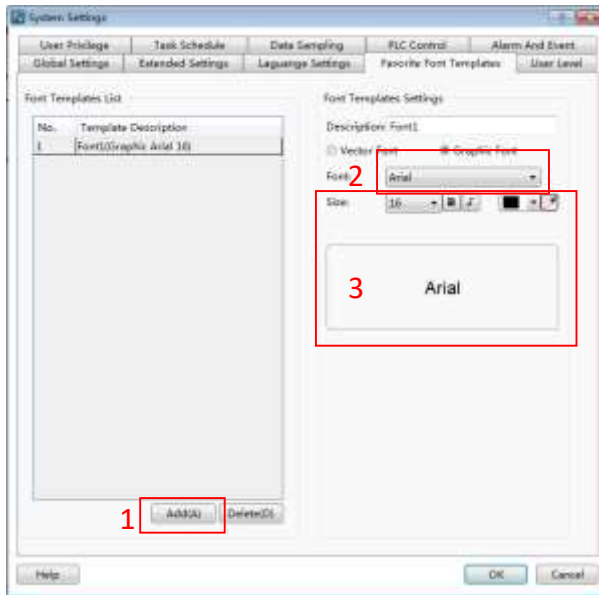

4.10.2.4.3 Use a font template

For example, a font template is used in the property settings of a Static Text component.

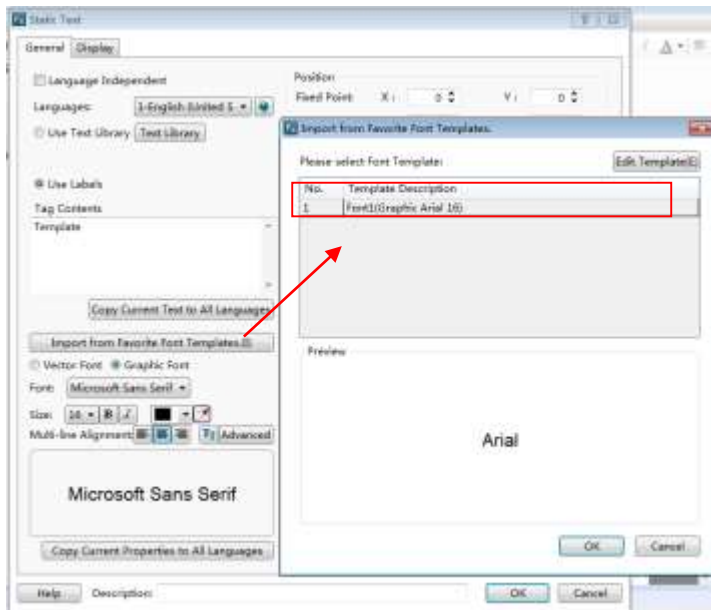

First, click the button "Import from Favorite Font Templates" in the property window of a Static Text component to open the "Import from Favorite Font Templates" dialog. Then select the required font template and click the OK button. The result is shown as below.

VEDA HCT User Manual



4.10.2.5 User Level

You can set the levels and the level passwords for the users in the “User Level” settings page. The settings of the “User Level” are valid in the whole HMI system. The higher the level is, the greater the range which can be operated is. The higher user level can access the screen windows which the lower user level can access. But it is not prohibited that the lower user level accesses the higher user level.

4.10.2.5.1 Open

The “User Level” settings page can be opened by double-clicking the “User Level” option in the System Settings of the project tree or click the menu command “Setup/ System Settings /User Level”.

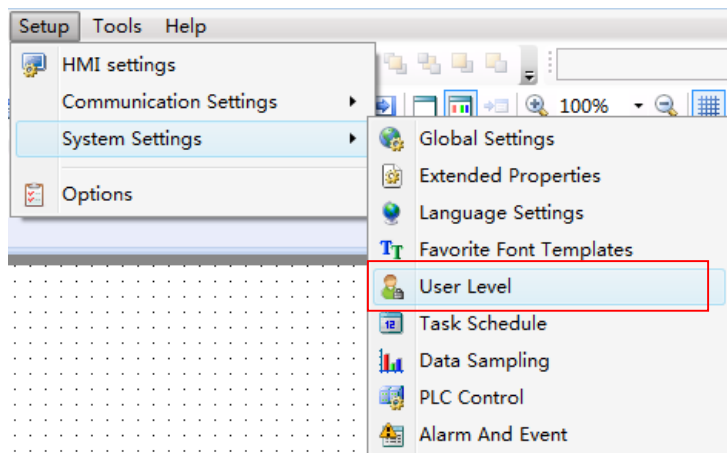
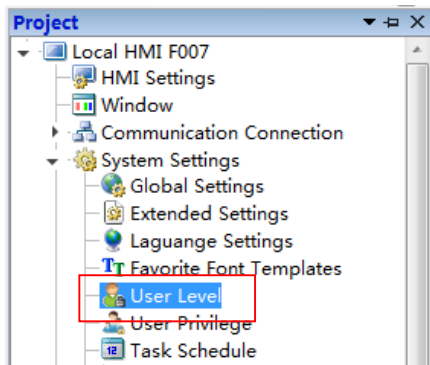

4.10.2.5.2 Edit

VEDA HCT User Manual

The "User Level" settings page is shown as below.

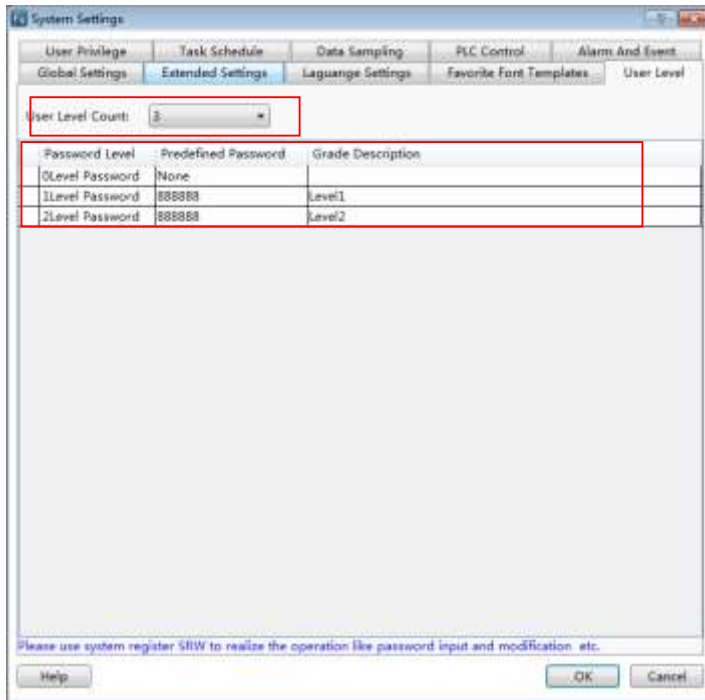

You can set the number of the user level in the "User Level Count" by using the list. And you can edit the information of every user level in the table, such as the Predefined Password and the Grade Description.

4.10.2.5.3 Use

For example, set the user level function for the "Bit Switch" component.

Open the property window of the "Bit Switch" component and select the option "Conditional" in the property TAB of "Control Settings". Check the option "Level User" and select the level from the list. It is shown as below.

VEDA HCT User Manual



Run the project. A “User level login” window will pop up when you click the component. It is shown as below. You can operate the component only by entering the correct password in the “User level login” window.

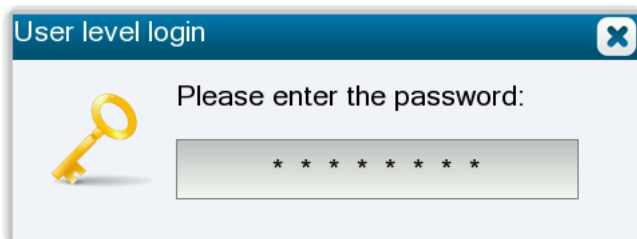

4.10.2.6 User Privilege

The “User Privilege” is used to provide security for the user operations. The different privilege is given when the user enter the different user name and the corresponding password.

4.10.2.6.1 Add

The “User Privilege” settings page can be opened by double-clicking the “User Privilege” option in the System Settings of the project tree or click the menu command “Setup/ System Settings /User Privilege”.

VEDA HCT User Manual

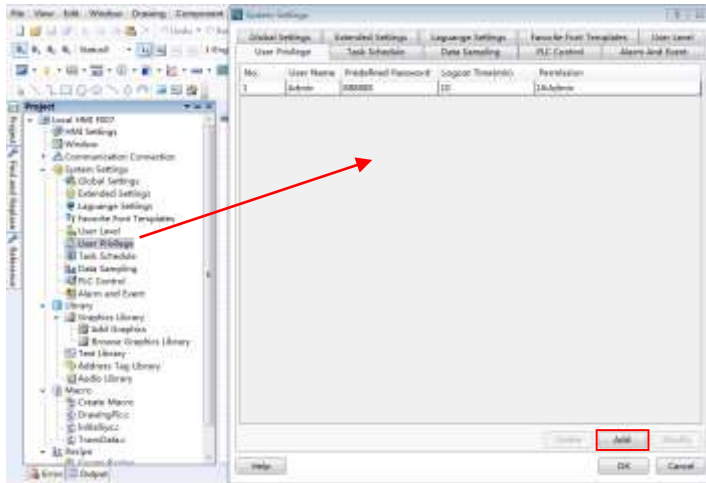

After clicking the button "Add", the "User Privilege Settings" dialog will pop up.

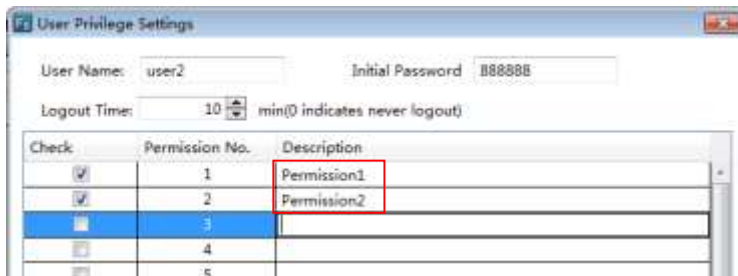

4.10.2.6.2 Set

You can set different User names, Initial Password and Logout Time for different privileges in the "User Privilege Settings" dialog. The login state of the current user will exit if the login time is more than the Logoff Time.

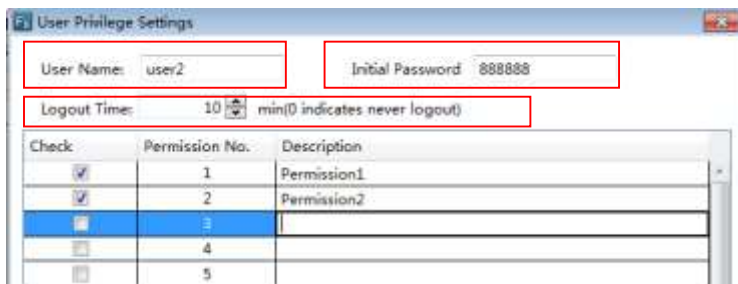

4.10.2.6.3 Use

You can use the "User Privilege" in many situations, such as the control settings, the window switch, the value input, and so on.

VEDA HCT User Manual

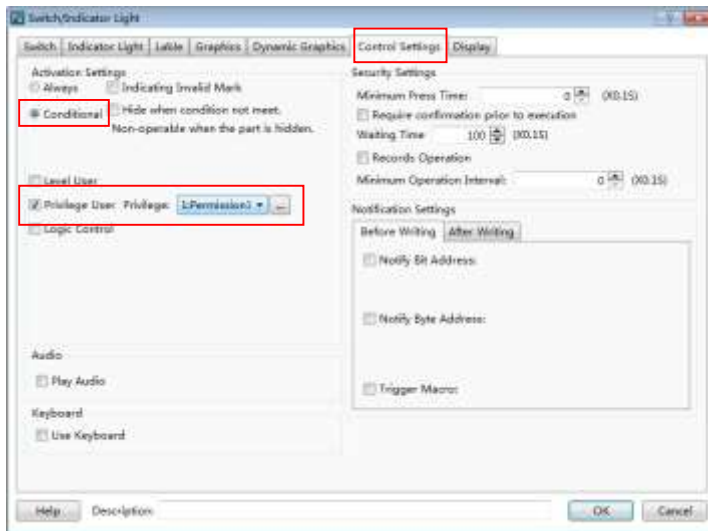

4.10.2.6.4 Call

You can find some windows which the system provides in the project tree, such as the User privilege window, the User login window, and so on. These windows make it easy to use for the users.

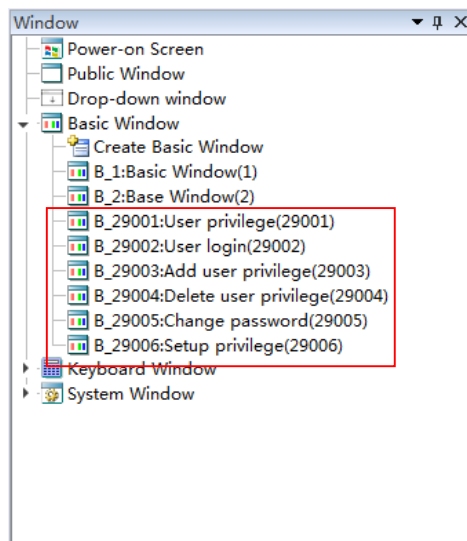

4.10.2.7 Task Schedule

The “Task Schedule” is used to execute some operations when time is up.

You can open the “Task Schedule” property TAB by clicking the menu command "Setup/ System Settings/Task Schedule". It is shown as below.

VEDA HCT User Manual

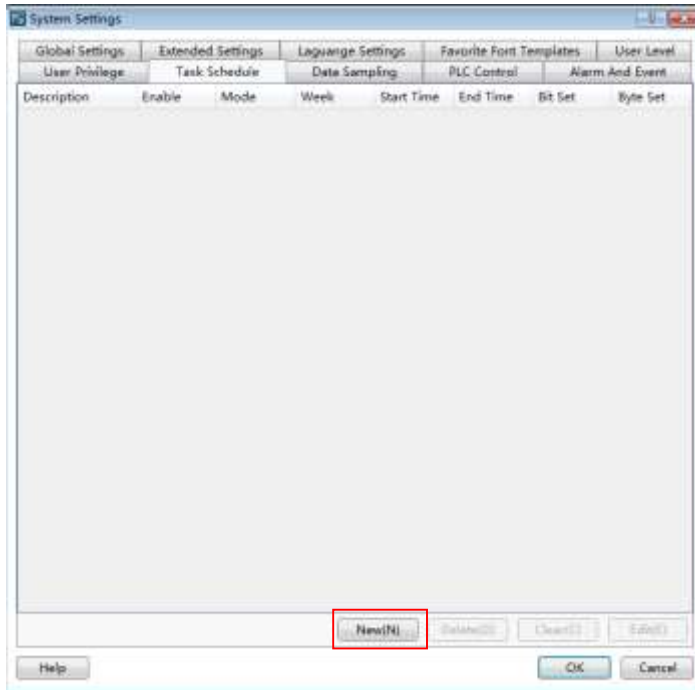

After click the button "New(N)", the "Task Schedule Details" window pop up. It is shown as below.

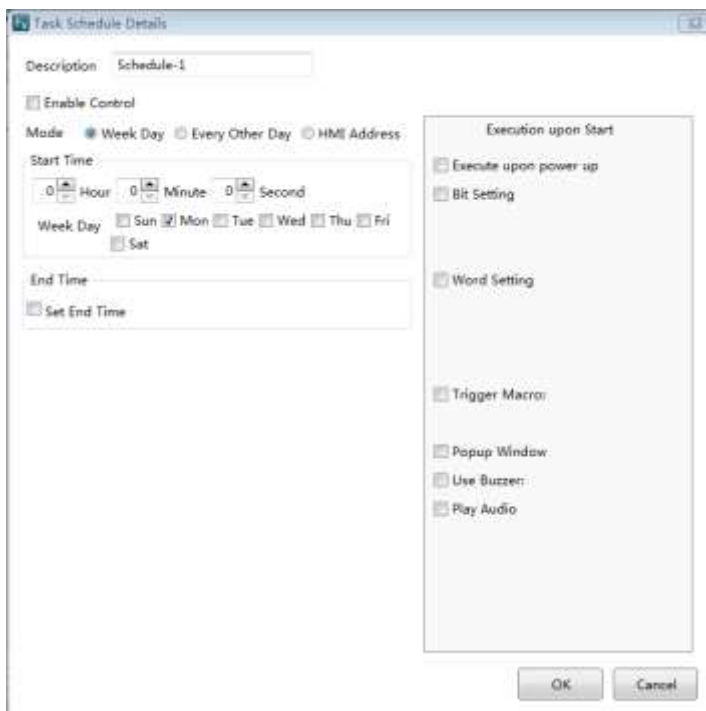

4.10.2.7.1 Description

You can give a name for the task schedule in the "Description" edit box. This description can facilitate the identification in programming.

VEDA HCT User Manual

4.10.2.7.2 Enable Control

After you check the option “Enable Control”, you can select a bit register. When the bit is ON, this Task Scheduler is not allowed to use.

4.10.2.7.3 Mode

- Week Day

The start time and the end time are within a week.

- Every Other Day

The start time and the end time can execute in the adjacent two weeks. The Week Day of the start time is only selected one. You must set the end time.

Mode Week Day Every Other Day HMI Address

Start Time

6 Hour 0 Minute 0 Second

Week Day Sun Mon Tue Wed Thu Fri Sat

End Time

Set End Time

21 Hour 0 Minute 0 Second

Week Day Sun Mon Tue Wed Thu Fri Sat

- HMI Address

Use word registers to set the mode.

Mode Week Day Every Other Day HMI Address

Related to address variable

Start Address (9 Registers) LW0

Mode: LW0 0 Specified Week Day, =1 Every Other Day

Start Time:Hour:LW1 Minute:LW2 Second:LW3

Start Week: LW4 Bit0~Bit6 are corresponding to 7 weekdays starting From Sunday To Saturday.

End Time:Hour:LW5 Minute:LW6 Second:LW7

Finish Week: LW8 Bit0~Bit6 are corresponding to 7 weekdays starting From Sunday To Saturday.

4.10.2.7.4 Execution upon Start and Execute upon End

VEDA HCT User Manual

Only an “Execution upon Start” setting page is displayed by default. The “Execute upon End” setting page is visible if you check the option “Set End Time”. They are shown as below.

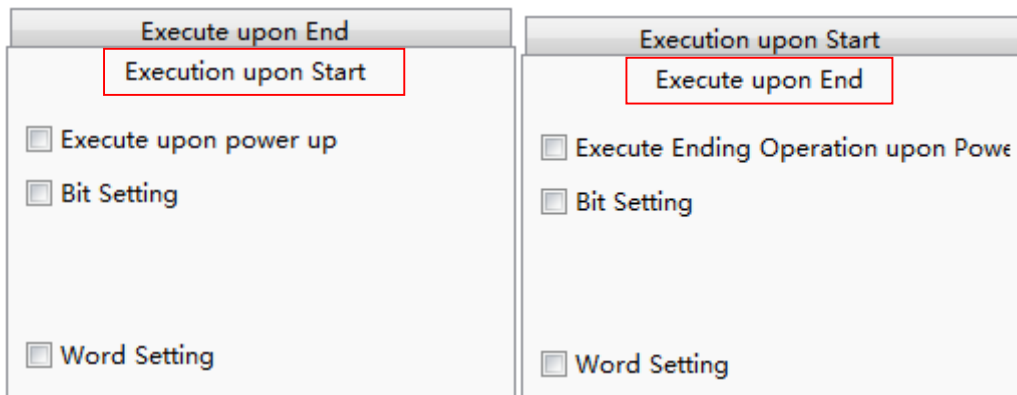

The operations need to be executed are listed in the “Execution upon Start” setting page and the “Execute upon End” setting page.

- Execute upon power up

If you check the option “Execute upon power up”, the operations checked in the “Execution upon Start” setting page will be executed in the time range (start time - end time). It will stop outside the time range.

- Execute Ending Operation upon Power Off

If you check the option “Execute Ending Operation upon Power Off”, the operations checked in the “Execute upon End” setting page will be executed in the time range (start time - end time). It will stop outside the time range.

- Bit Setting

This operation is to set a bit register ON or OFF.

- Word Setting

This operation is to change the value of a word register.

- Trigger Macro

This operation is to trigger a Macro.

- Popup Window

This operation is to pop up a window.

VEDA HCT User Manual

- Use Buzzer

This operation is to make the internal buzzer of HMI to ring.

- Play Audio

This operation is to play an audio.

4.10.2.8 Data Sampling

The "Data Sampling" is the data source of these components such as the "Trend Curve", the "Historical Data Display", and so on. You must create the "Data Sampling" before using these components. You can open the "Data Sampling" property TAB by clicking the menu command "Setup/ System Settings/Data sampling". It is shown as below.

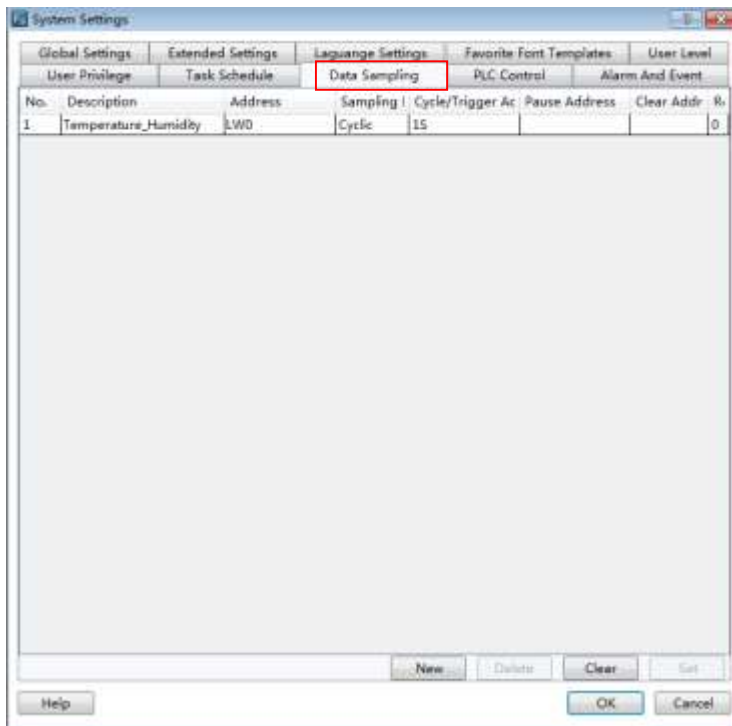

4.10.2.8.1 Property Setting

After clicking the button "New" in the "Data Sampling" property TAB, the "Data Sampling Property" dialog will pop up. It is shown as below.

VEDA HCT User Manual

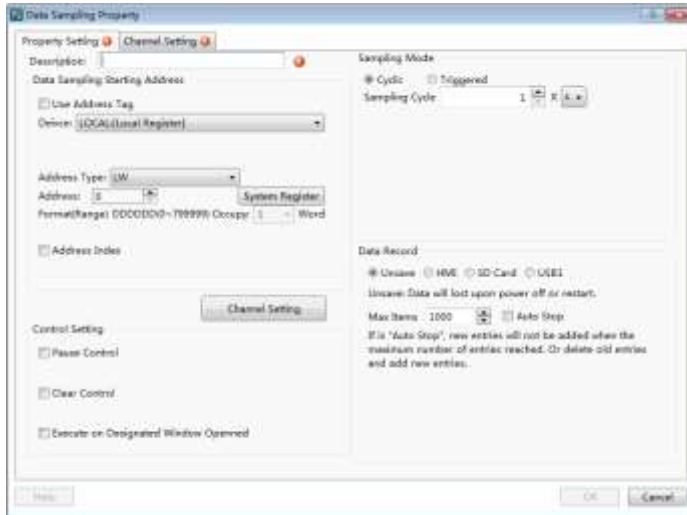

- **Description**

The “Description” is used as the name of the “Data Sampling”. It is a required the attribute. If it is null, there will be a red exclamation mark to indicate that a name is needed here. The “Description” can be a text which is easy to understand, such as “Level of Tank 1”, “Temperature of Main Motor”, and so on.

- **Data Sampling Starting Address**

A word register is needed to specify as the start address of the data sampling here. It is can be an internal address of the HMI and the register address of the controller which is connected to the HMI.

- **Control Setting**

Three attributes of the Control Setting are optional. They are not be checked by default. You can check or not check them according to the actual needs.

- **Pause Control**

If the “Pause Control” is checked, you can set a bit address to control the data sampling. When this bit address is ON, the data sampling is paused. When it is OFF, the data sampling will continue.

- **Clear Control**

If the “Clear Control” is checked, you can set a bit address to clear the sampling data. When this bit address is ON, all the sampling data in the memory is cleared.

- **Execute on Designated Window Opened**

VEDA HCT User Manual

After checking this attribute, you can specify a window when the window is set to open, the above "Pause control" and "clear control" to be effective.

If the "Execute on Designated Window Opened" is checked, you can specify a window. When this window is opened, the settings of "Pause Control" and "Clear Control" are valid.

- **Sampling Mode**

The Sampling mode can be "Cyclic" or "Triggered". The default is "Cyclic".

- **Cyclic**

The unit of the Sampling Cycle can be "s" or "0.1 s". The default is 1 s.

- **Triggered**

If you select the "Triggered" option, the data sampling will be done according to the "Trigger Condition". The Trigger Mode includes "Bit" and "Word". The "Address" is needed to specify according to the Trigger Mode. The "Trigger Condition" of Bit Trigger Mode can be "OFF→ON", "ON→OFF" or "OFF↔ON". For Word Trigger Condition, you can refer to: [Detailed manual/General functions/Drawing/Logic Control](#).

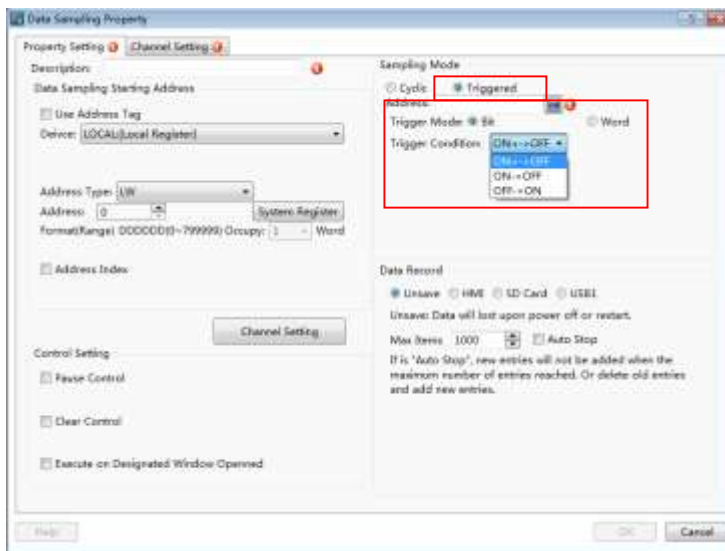

- **Data Record**

You can save the sampling data to the HMI or other peripherals. The default is "Unsave". That is, the sampling data is not saved.

- **Unsave**

VEDA HCT User Manual

When you select “Unsave”, there will be a “Max Items” setting for the memory occupation. The default is 1000. The maximum is 99,999. The “Auto Stop” is not checked by fault. If the “Auto Stop” is checked, the new items will not be added when the maximum number of items reached. Or delete the oldest items and add the new items. It is shown as below.

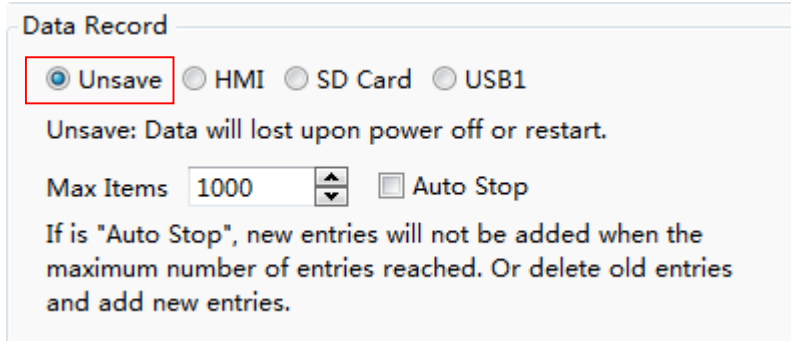

The screenshot shows a window titled "Data Record". At the top, there are four radio button options: "Unsave", "HMI", "SD Card", and "USB1". The "Unsave" option is selected and highlighted with a red box. Below the radio buttons, the text reads "Unsave: Data will lost upon power off or restart." Underneath, there is a "Max Items" field with a value of "1000" and a spin button, followed by an unchecked "Auto Stop" checkbox. A final note states: "If is 'Auto Stop', new entries will not be added when the maximum number of entries reached. Or delete old entries and add new entries."

Note:

All the sampled data will be lost if you select “Unsave”. After powering on, you need to sample the data again.

➤ HMI

When you select “HMI” for the Data Record, the “Subdirectory Name” is required.

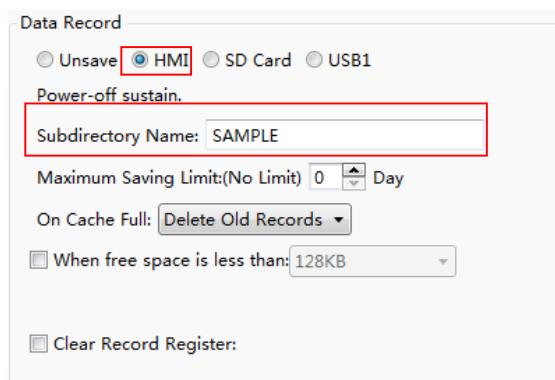

The screenshot shows the "Data Record" window with the "HMI" radio button selected and highlighted by a red box. Below the radio buttons, the text reads "Power-off sustain." Underneath, there is a "Subdirectory Name" field containing the text "SAMPLE", also highlighted by a red box. Below this, there is a "Maximum Saving Limit:(No Limit) 0" field with a spin button and the unit "Day". Underneath, there is a dropdown menu for "On Cache Full:" with "Delete Old Records" selected. Below that, there is an unchecked checkbox for "When free space is less than:" followed by a dropdown menu showing "128KB". At the bottom, there is an unchecked checkbox for "Clear Record Register:".

The “Maximum Saving Limit” option is set "0" Day by default. That means that there is no limit to save. However, there is a limit because of the limited capacity of the HMI Flash. It is suggested that the “Maximum Saving Limit” option is set several days when you select HMI to save data, such as 15 days, 30 days, and so on.

The default action is “Delete Old Records” when the Flash memory of the HMI is full. This is a cycle record mode. You can also select "Discard New Records" option. It is a fixed-saving mode which the new records are no longer saved when the Flash memory is full.

VEDA HCT User Manual

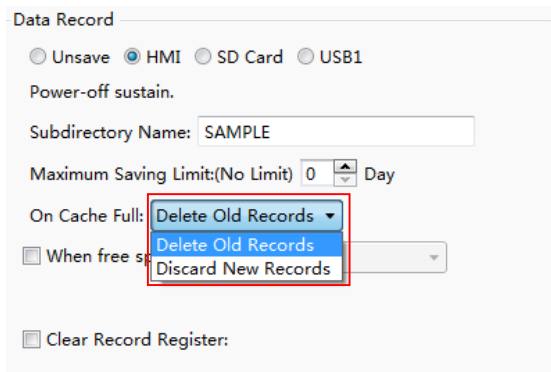

If you check the option “When frees pace is less than”, the action of “Notify Register” will be done when the free space is less than the specified capacity. The capacity range is 16KB ~ 2MB. You can set a bit register to notify. The bit register will be ON when the free Flash capacity is less than the specified.

If you check the option “Clear Record Register”, you can specify a "bit register". When the "bit Register" is ON, all the saved history records will be cleared.

For example, you want to save the data record to the “SAMPLE” folder in the HMI. The bit register LB0 will be ON to indicate insufficient space when the free space is less than 128KB. All saved history records will be deleted when the bit register LB1 is set ON. The settings are shown as below.

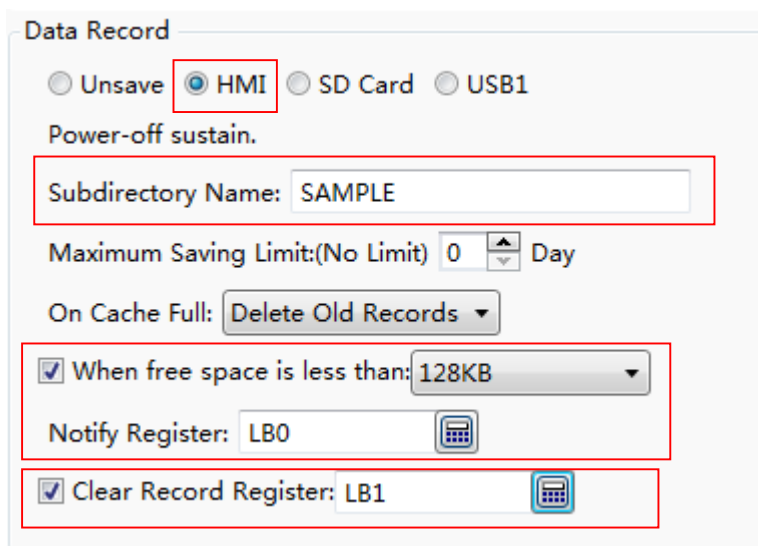

➤ SD Card and USB1

You can choose to save the data records to SD card or USB disk. The settings are referred to the “HMI”.

4.10.2.8.2 Channel Setting

VEDA HCT User Manual

The "Channel Settings" property TAB is shown as below.

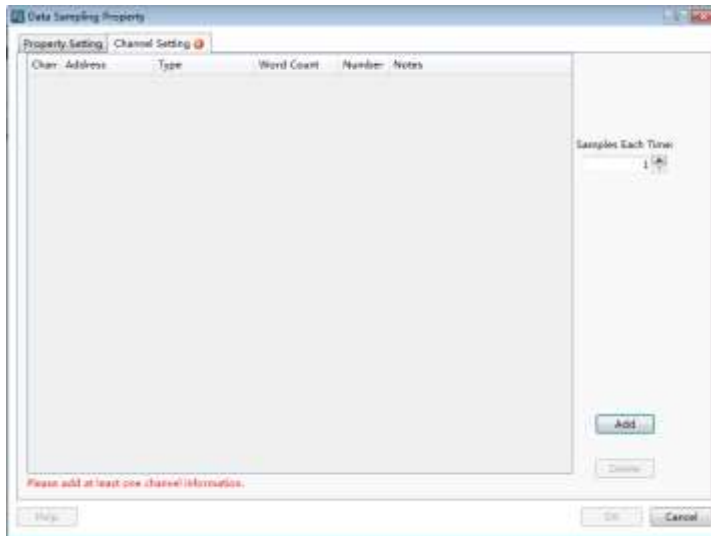

There will be a red exclamation mark here due to no channel.

- **Add channel**

After clicking the button "Add", an item will be added. It is shown as below.

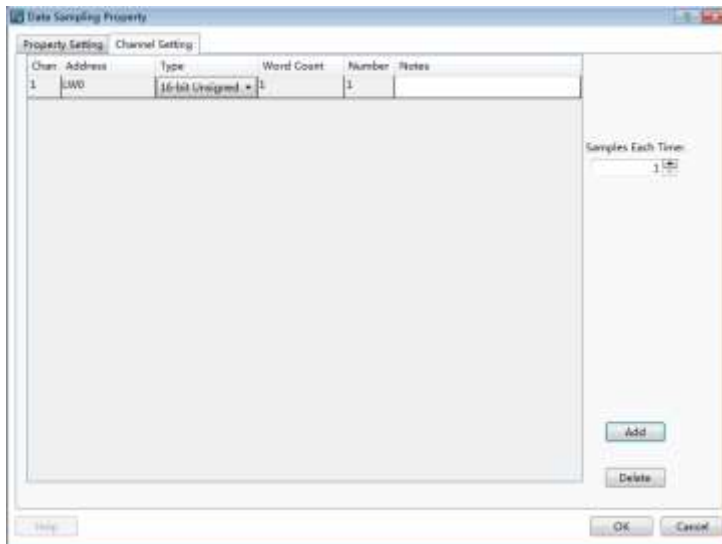

The "Address" refers to the start address of the data record. The "Type" of data record can be "16-bit Unsigned", "16-bit Signed", "32-bit Unsigned", "32-bit Signed", "16-bit BCD", "32-bit BCD", "Single-precision Floating-point Number" or "Character String". The maximum memory occupied is 64 word registers for the type of "Character String".

VEDA HCT User Manual

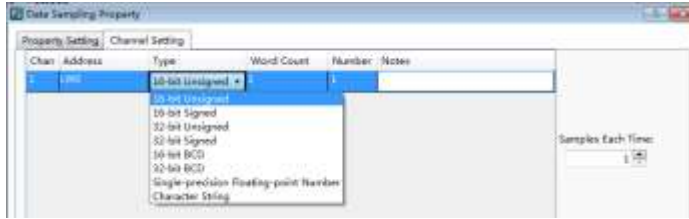

You can create many channels by clicking the button "Add". The addresses of the data record are continuous and specified automatically. It is shown as below.



- **Samples Each Time**

The default value of "Samples Each Time" is 1. That means that one data is sampled each time. When this parameter is set a value larger than 1, the addresses which each channel occupies will multiply. For example, the option "Samples Each Time" is set 3. Then the number of address occupied by each channel is shown as below.

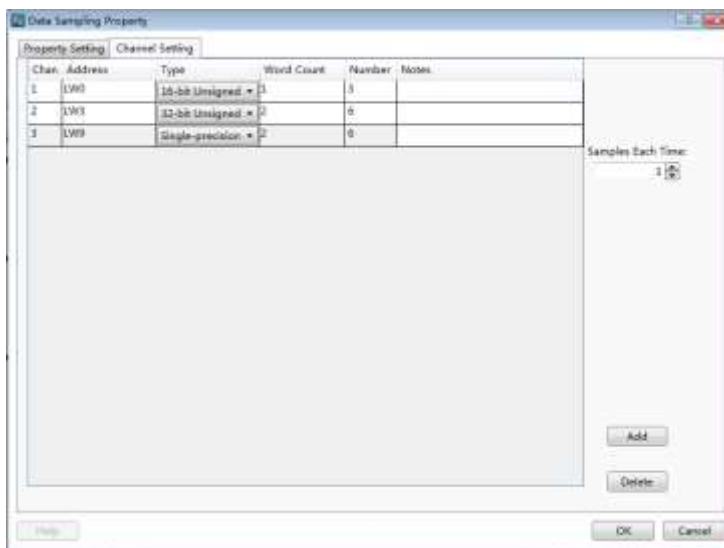

VEDA HCT User Manual

In this example, LW0 ~ LW2 is occupied by the first channel, LW3 ~ LW8 is occupied by the second channel, and LW9 ~ LW14 is occupied by the third channel. The number of addresses is three times as the number which the "Samples Each Time" is set 1.

- **Delete channel**

You can delete the selected channel by clicking the button "Delete".

- **Notes**

In the "Notes" column of each channel, you can give a description. The "Notes" makes it easy to read and it will display in the "Historical Data" table. For example, the first channel is "Liquid level", the second channel is "Pressure", and the third channel is "Flow". It is shown as below.

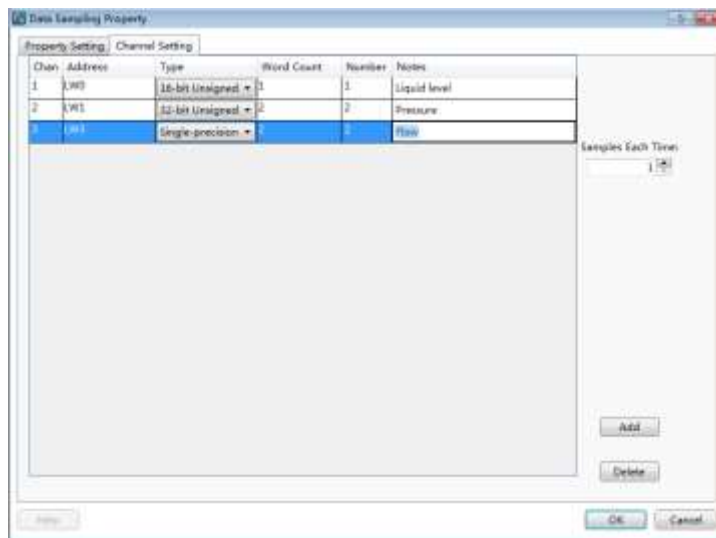

- **Sample Using Serial Address**

You can set the non-serial address sampling channel if the option is not checked.

VEDA HCT User Manual

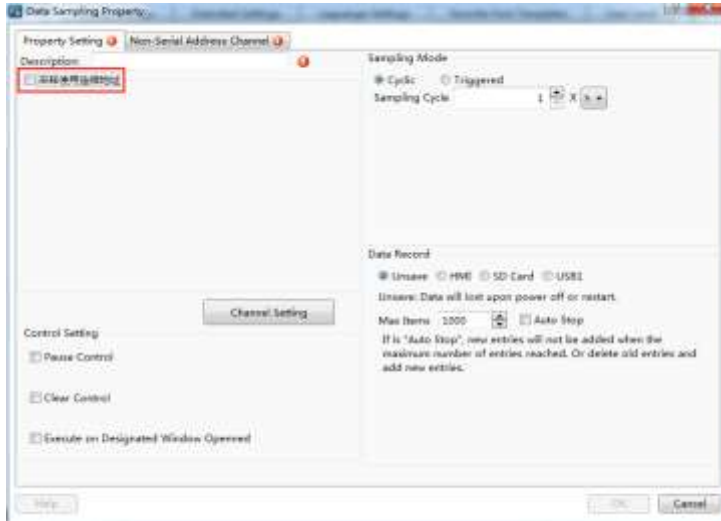

- **Non-Serial Address Channel**

Click the "Non-Serial Address Channel" button, then the "Non-Serial Address Channel" page will display.

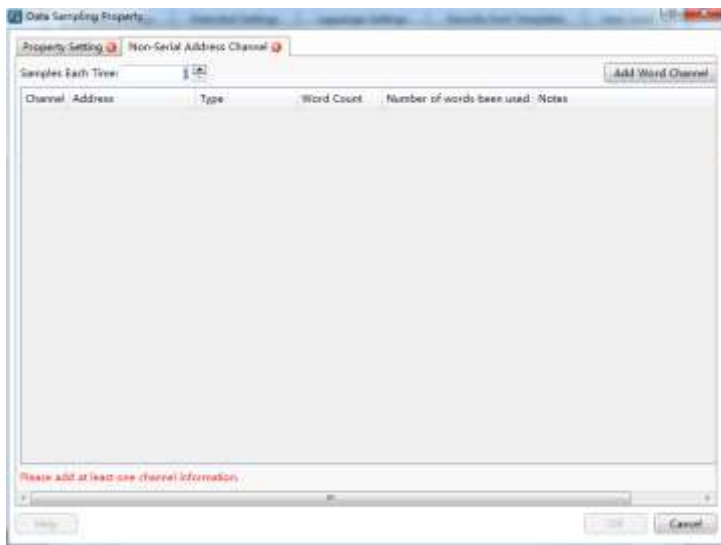

Add Word Channel:

Click the "Add Word Channel" button, there will be a entry of data sampling, then you can click the address button to edit the address, then you can choose device and address type. The length of the sampling points can be set by the option of "Samples Each Time". You can click the "Add Word Channel" again, continue to add a channel, the new channel address can be defined by yourself, and it does not need to continue with the last channel address. As shown in the following figure:

VEDA HCT User Manual

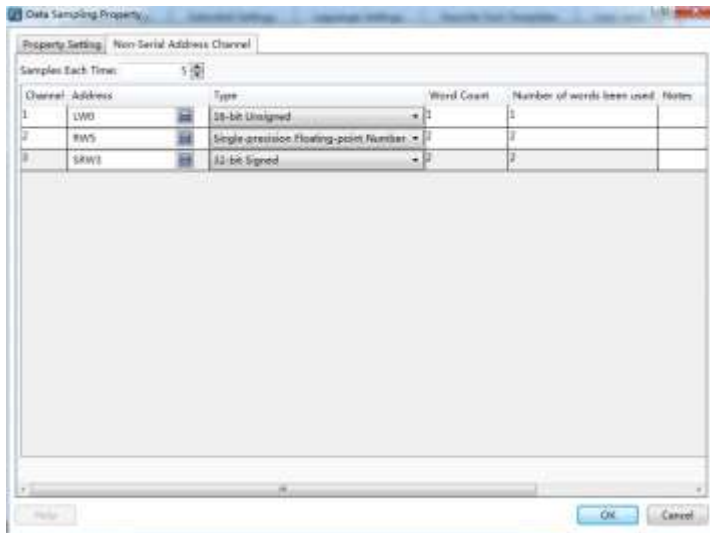

It can be seen that the sampling addresses of multiple channels could be non-continuous addresses.

Samples Each Time

The default is 1, which means 1 point per sample. When the value is set more than 1, the sampling points of each channel is changed to the set value.

4.10.2.9 PLC Control

The "PLC Control" attribute is used to execute an action according to the change of the address of the local HMI or the controller connected to the local HMI. This is a global Attribute. That is, the action of the "PLC Control" will be executed regardless of which one the current screen window is, as long as the conditions are met.

After clicking the menu command "Setup / System Settings / PLC Control", the "PLC Control" settings page will be opened. It is shown as below.

VEDA HCT User Manual

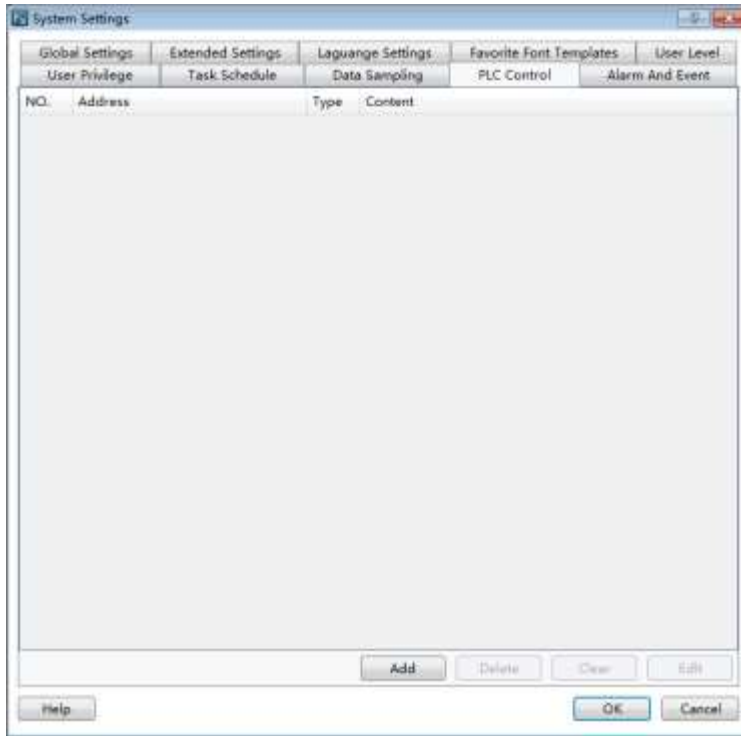

Click the button "Add" in the "PLC Control" settings page, the "PLC Control Details" settings dialog will pop up. It is shown as below.

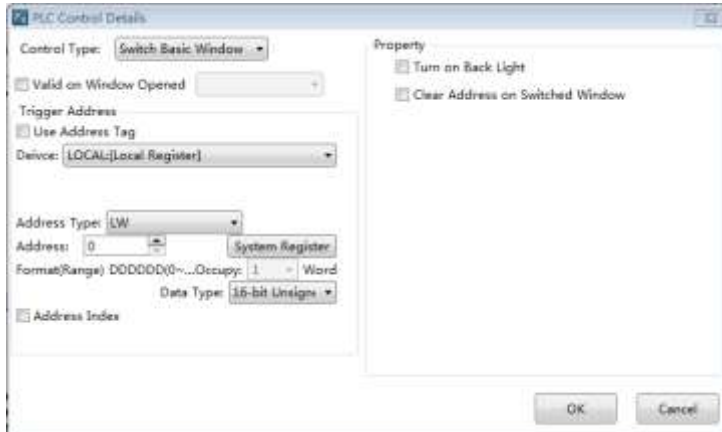

The "Control Type" refers to the action of the "PLC Control". It includes "Switch Basic Window", "Report Current Window No.", "Back Light Control", "Execute Macro Instruction", "Audio Control", "Sheet Print", and "Force Buzzer off".

VEDA HCT User Manual

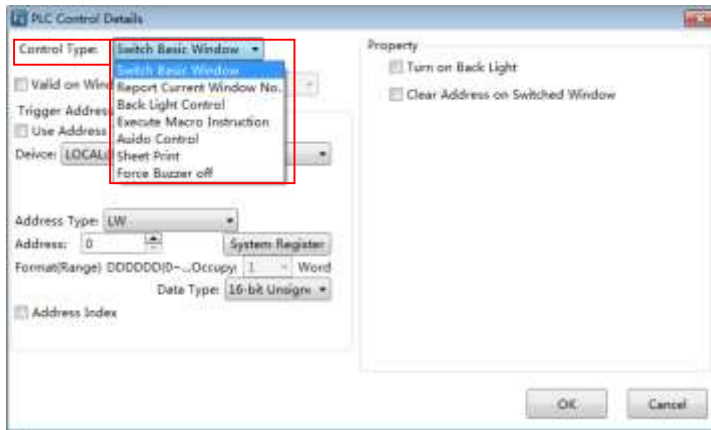

4.10.2.9.1 Switch Basic Window

You can switch the basic window of the HMI by changing the value of a register.

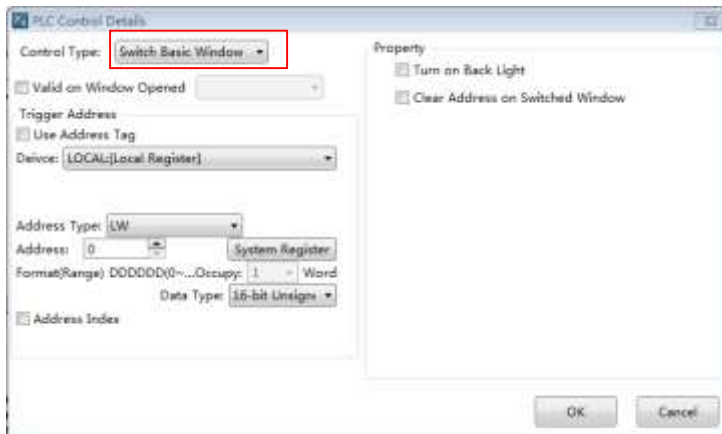

- Valid on Window Opened

The “Valid on Window Opened” is a public attribute of the “PLC Control”. By default, it is not checked. After checking this attribute, you can select a base window. The action defined in the "PLC control" will be executed when the specified base window is switched to open.

- Trigger Address

You can select a word register to trigger the “Switch Basic Window” action. For example, if the “Trigger Address” is set LW100, the HMI will display the Basic Window(1) when the value of LW100 is 1, and the HMI will automatically switch to the Basic Window(20) when the value of LW100 is 20. And so on.

- Property

VEDA HCT User Manual

There are two optional attributes in the “Property” box. They are not checked by default.

- ✧ Turn on Back Light

If you check the option “Turn on Back Light”, the back light will be turned on automatically when the action of “Switch Basic Window” is executed and the back light is closed.

- ✧ Clear Address on Switched Window

If you check the option “Clear Address on Switched Window”, the value of the word register will be cleared to zero automatically after the action of “Switch Basic Window” is finished.

After click the "OK" button, the “PLC Control” action will be added in the “ PLC Control” settings page.

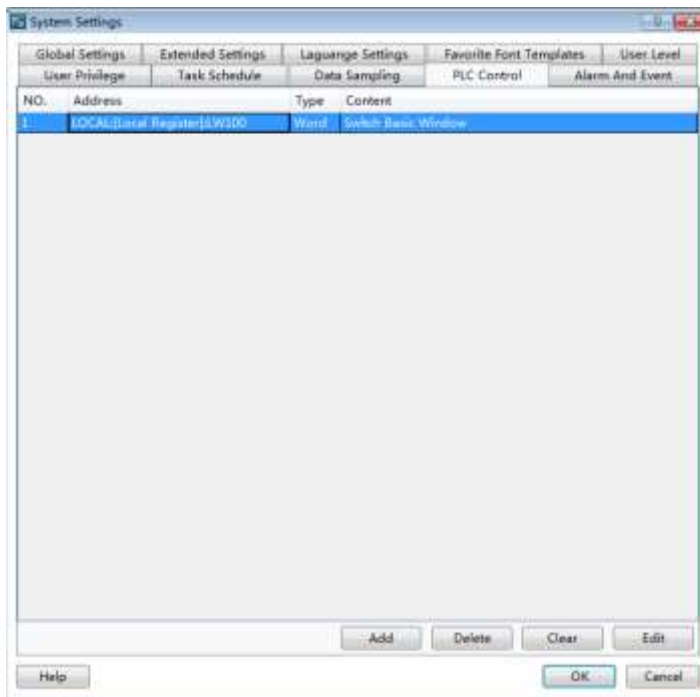

Note:

The “Switch Basic Window” action will be triggered only when the value of the trigger address changes. You can also use a Bit Set component to switch the base window in the VEDA HCT software. But the switch basic window action may not be executed if you use the two switch window methods. For example, after you input a value to the trigger address to switch the basic window, you switch another basic window by using the Bit Set component. Then you input the same value to the trigger address to

VEDA HCT User Manual

switch the first basic window. But it does not act because the value of the trigger address does not change. To avoid this situation, you should check the option "Clear Address on Switched Window".

4.10.2.9.2 Report Current Window No.

The current window number can be recorded to a register.

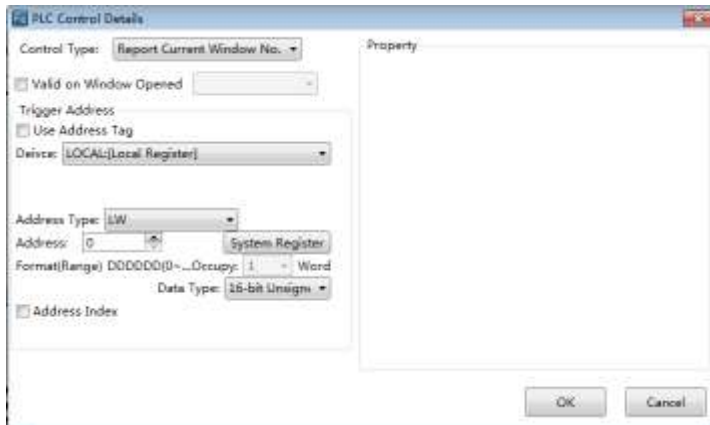

- Trigger Address

You can select a word register to trigger the "Report Current Window No." action. For example, if the "Trigger Address" is set LW200, the number of the current basic window will be moved to LW200 when the HMI displays a window. If the HMI device displays the Basic Window (18), then the value of LW200 is equal to 18.

4.10.2.9.3 Back Light Control

You can define a trigger condition to control the state of the back light if you select the "Back Light Control" as the control type.

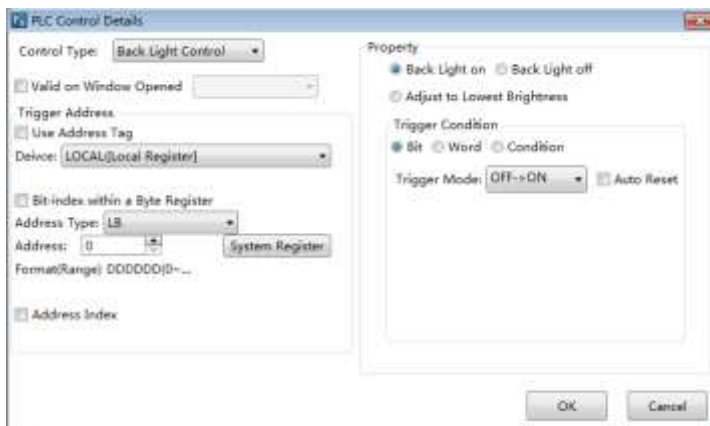

VEDA HCT User Manual

- Back Light on

The option “Back Light on” is selected by fault. If this option is selected and the trigger condition is satisfied, the back light will be turned on when the back light is closed or in the lowest lightness.

- Back Light off

If the option “Back Light off” is selected and the trigger condition is satisfied, the back light will be turned off.

- Adjust to Lowest Brightness

If the option “Adjust to Lowest Brightness” is selected and the trigger condition is met, the back light of the HMI will be adjusted to the lowest lightness.

- Trigger Address

The “Trigger Address” can be a word or bit register. It depends on the setting of the “Trigger Condition”.

- Trigger Condition

You can select “Bit”, “Word” or “Condition” for the “Trigger Condition”. If you select “Bit” or “Word”, the condition is determined by the register which is given in the “Trigger Address”. If you select “Condition”, the condition needs to be given by the logic control editor box.

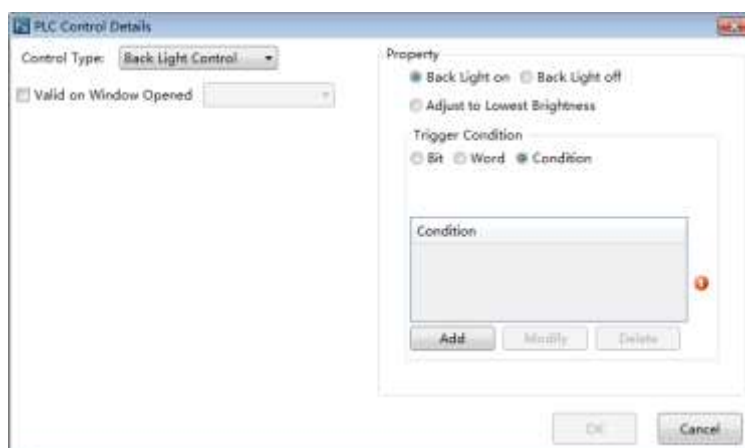

The detailed of “Condition” setting is referred to: [Detailed manual/ General functions/ Drawing/ Logical Control.](#)

VEDA HCT User Manual

4.10.2.9.4 Execute Macro Instruction

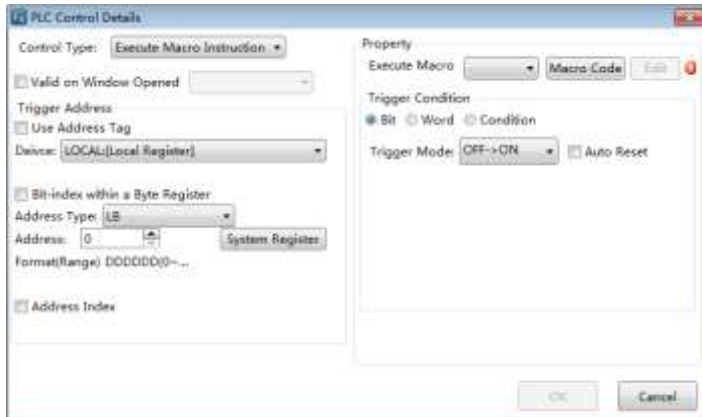

- Execute Macro

You can select a Macro from the list. The selected Macro will be executed when the Trigger Condition is achieved. If you have not created a Macro, there will be a red exclamation mark to prompt that any one macro has not been established. Click the button "Macro Code", you can open the Edit Macro window.

- Trigger Address

The "Trigger Address" can be a word or bit register. It depends on the setting of the "Trigger Condition".

- Trigger Condition

You can select "Bit", "Word" or "Condition" for the "Trigger Condition". If you select "Bit" or "Word", the condition is determined by the register which is given in the "Trigger Address". If you select "Condition", the condition needs to be given by the logic control editor box.

The detailed of "Condition" setting is referred to: [Detailed manual/ General functions/ Drawing/ Logical Control.](#)

4.10.2.9.5 Audio Control

You can control the internal buzzer of the HMI or the audio from the "Audio Library" by using the control type of "Audio Control". This function is invalid if the audio output is not supported by the HMI device.

VEDA HCT User Manual

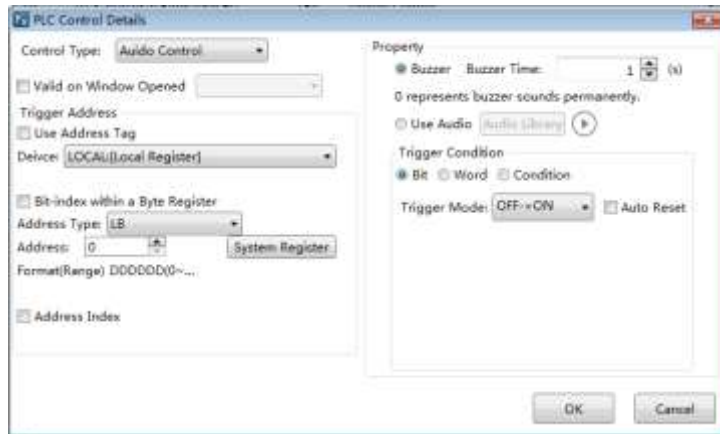

- Buzzer

The option "Buzzer" is selected by default. If it is selected, the internal buzzer of the HMI will ring when the trigger condition is satisfied. The "Buzzer Time" is used to set the time of buzzer ringing. It is 1 second by default. The max value of the "Buzzer Time" is 100 seconds. When the "Buzzer Time" is set "0", the buzzer will continue ringing until the trigger condition is not satisfied.

- Use Audio

If the option "Use Audio" is selected, you can select an audio from the "Audio Library". When the "Trigger condition" is satisfied, the audio will be played.

- Trigger Address

The "Trigger Address" can be a word or bit register. It depends on the setting of the "Trigger Condition".

- Trigger Condition

You can select "Bit", "Word" or "Condition" for the "Trigger Condition". If you select "Bit" or "Word", the condition is determined by the register which is given in the "Trigger Address". If you select "Condition", the condition needs to be given by the logic control editor box.

The detailed of "Condition" setting is referred to: [Detailed manual/ General functions/ Drawing/ Logical Control](#).

4.10.2.9.6 Force Buzzer off

VEDA HCT User Manual

You can specify a bit register to force the buzzer off by using the control type of “Force Buzzer off”. When the state of the buzzer is ON, it will be forced to OFF if the specified bit register is ON.

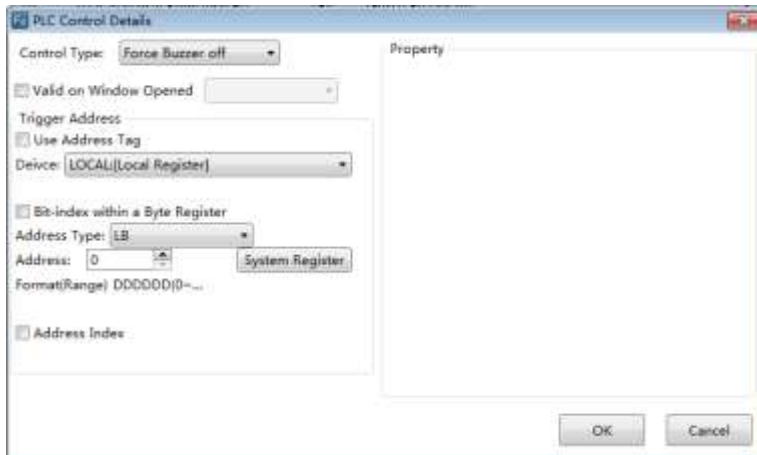

4.10.2.10 Alarm And Event

You can preset the attributes of the alarms or events such as the conditions and contents in the “Alarm And Event” settings page. The “Alarm And Event” settings page can be opened by clicking the menu command “Setup/System Settings/Alarm And Event”.

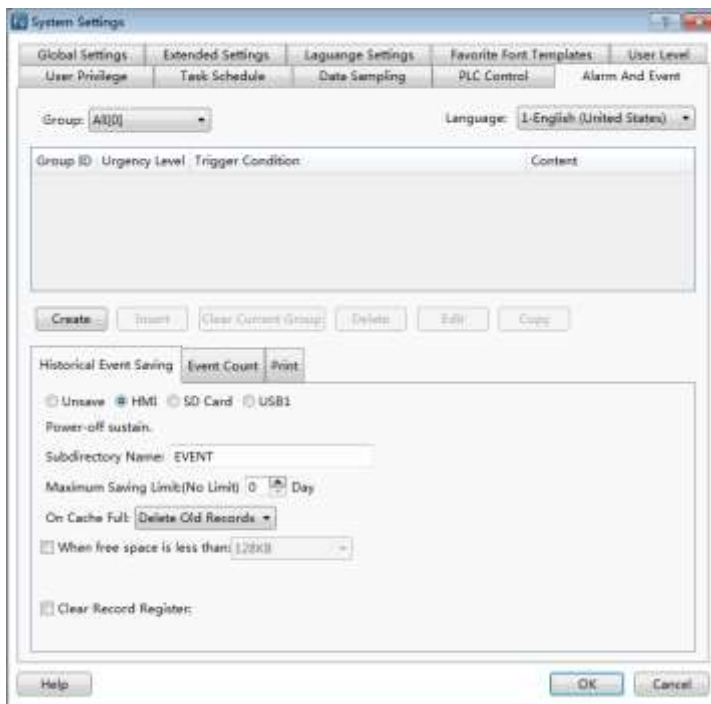

4.10.2.10.1 Group

VEDA HCT User Manual

The alarms and events can be viewed by groups. The users can customize the groups. Here, the option “Group” can be set any one of “All, 1, 2, 3 ...32”.

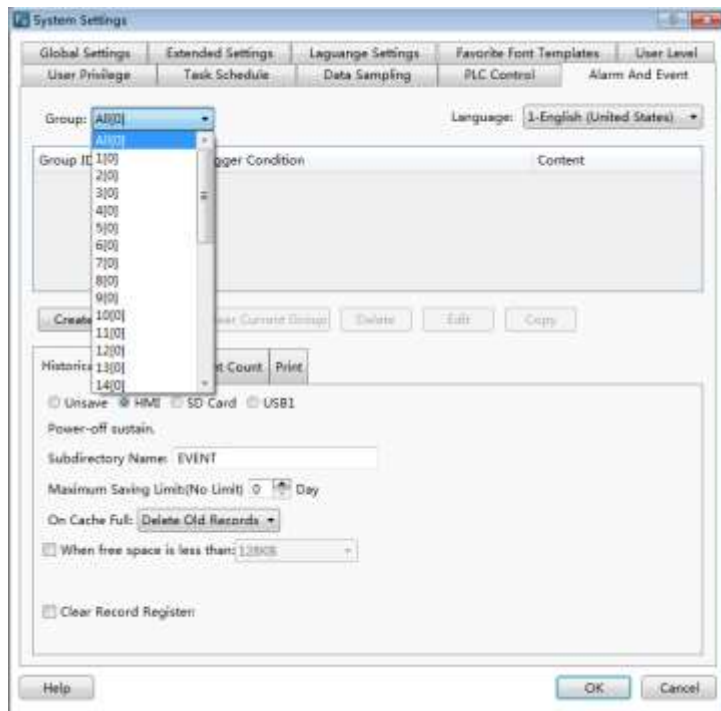

4.10.2.10.2 Language



The alarm content can be displayed in different languages. So you need select a language for the option “Language” to view the alarm content.

4.10.2.10.3 Create and set

After selecting a Group, then click the button “Create”, the “Alarm and Event Detailed Setting” window will pop up. It is shown as below.

VEDA HCT User Manual

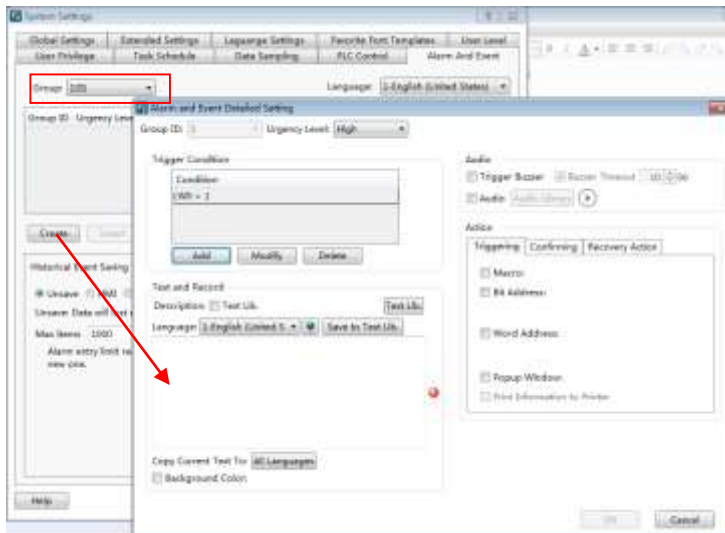

- Group ID

If you select “All” for the “Group” in the settings page, the “Group ID” can set any one of 1~32 here. If you select any one of 1~32 for the “Group” in the settings page, the “Group ID” is same to the “Group”. It refers to the group of the alarm or event waiting for be set here.

- Urgency Level

The “Urgency Level” can be set “High”, “Medium” or “Low”. You can set it according to the priority level of the alarm or event.

- Trigger Condition

The trigger condition of the alarm or event can be set here by using the button “Add”, “Modify” or “Delete”. The details can be referred to: [Detailed manual/General functions/Address editor/Standard Bit Address Input](#) and [Detailed manual/General functions/Address editor/Standard Byte Address Input](#).

- Text and Record

- Description: Text Lib

You can input the description for the current alarm or event in the edit box here. Or you can check the “Text Lib” and use a text of the Text Lib as the description. The “Text Lib” is referred to: [Detailed manual/Libray/Text Library](#).

- Language

VEDA HCT User Manual

You can select a language for the current display language here. If you check the “Text Lib” and use a text in the Text Lib as the description, the content in the edit box will only be viewed and not be edited. It can be viewed in different language by switching the Language.

Text and Record

Description: Text Lib.

Language: 1-English (United S)

Open

Background Color:

- Insert Watch Address

The display content of the alarm is the contents of the register address, the data type of the address support the “string” type.

Alarm and Event Detailed Setting

Group ID: Urgency level: High

Trigger Condition

Condition

Text and Record

Description: Text Lib.

Language: 1-English (United S)

Copy Current Text To:

Background Color:

Audio

Trigger Buzzer Buzzer Timeout: 10 (M)

Audio Loop

Action

Triggering Confirming Recovery Action

Macro

Bit Address:

Word Address:

Popup Window

Add Information to Notes

VEDA HCT User Manual

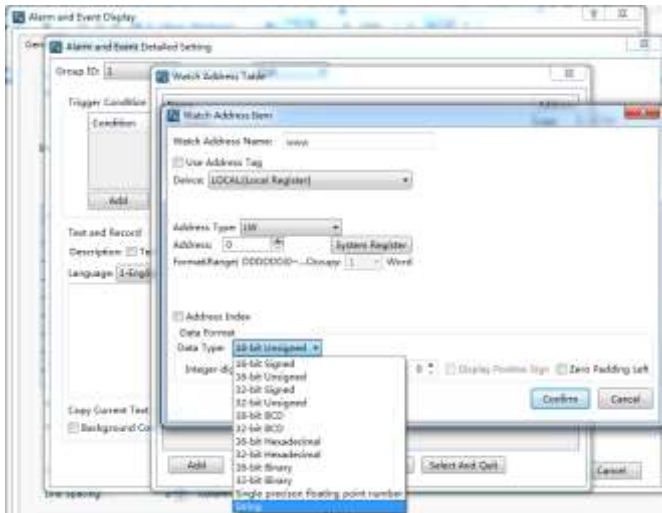

- Audio

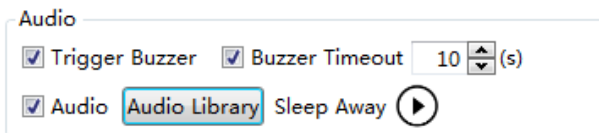

If the option “Trigger Buzzer” is checked, the internal buzzer of HMI will beep when an alarm occurs. If the option “Buzzer Timeout” is checked, you can set the beeping time of the buzzer. If the option “Audio” is checked, you can select an audio from the Audio Library as the sound of the alarm or event.

You can try to hear the audio by Click the button “”.

- Action

There are three kinds of actions according to the status of the alarm or event. They are “Triggering”, “Confirming” and “Recovery Action”. You can set the actions in different status for the alarm or event by clicking the title of the setting page “Triggering”, “Confirming” or “Recovery Action”.

VEDA HCT User Manual

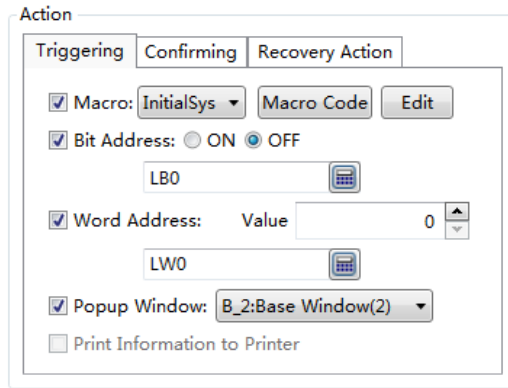

The actions of “Triggering” refers to the actions that they will be executed when the alarm or event occurs. The actions of “Confirming” refers to the actions that they will be executed when the alarm or event is acknowledged by manual. The actions of “Recovery Action” refers to the actions that they will be executed when the alarm or event exists.

➤ Macro

Select a Macro to execute as an action. You can also open the Macro Editor by clicking the button “Macro Code” or edit the Macro by clicking the button “Edit”.

➤ Bit Address

Set a bit register ON or OFF.

➤ Word Address

Write a value to a specified word register.

➤ Popup Window

Pop up a specified window.

➤ Print Information to Printer

Make the printer to print the corresponding information.

4.10.3 Communication Settings

4.10.3.1 Local Connection

The command “Local Connection” in the “Communication Settings” menu is used to set the communication parameters of the COM ports.

VEDA HCT User Manual

Select the corresponding COM port (COM1, COM2, COM3, or COM4) property TAB to set the communication parameters.

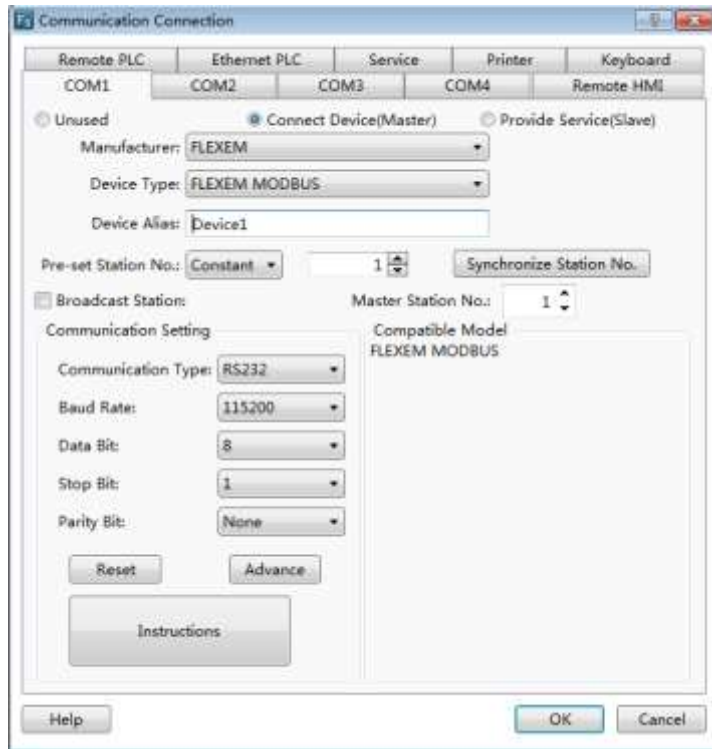

4.10.3.1.1 Unused

The option “Unused” is the default. It means the selected COM port is not used to communicate.

4.10.3.1.2 Connect Device (Master)

The option “Connect Device (Master)” needs to be selected when the touch screen is as master device. Then you need to set communication parameters for the corresponding PLC.

- Manufacturer

The option “Manufacturer” is used to set the manufacturer of the connected PLC.

VEDA HCT User Manual

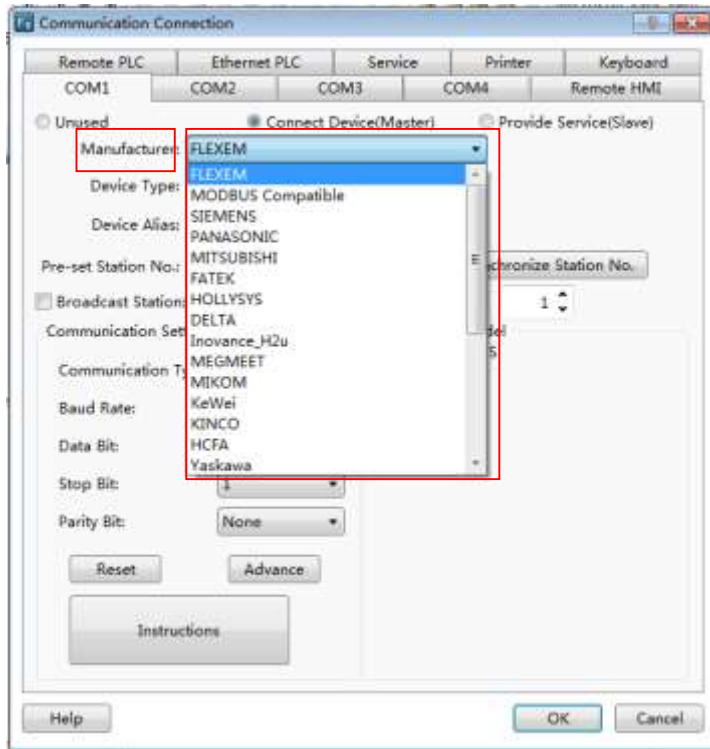

- Device Type

The Device Type refers to the corresponding type of the connected PLC.

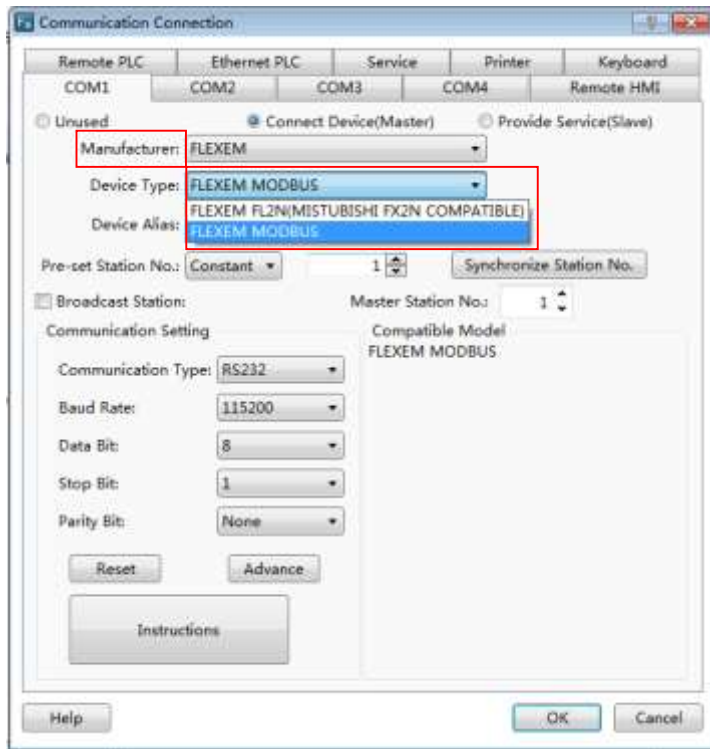

- Pre-set Station No.

VEDA HCT User Manual

The option “Pre-set Station No.” is used to set the PLC station number. You can set it by Constant or Variable.

You can input a fixed station number of the connected PLC by Constant way. It is the default station number for the new address. The station number which is already set will not change if you modify the preset station number. You can use the button “Synchronize Station No.” to unify the station number.

You can set the “Pre-set Station No.” by variable. It means the preset station number will depend on the value of a variable which you can input by a numeric value input component. The method to input the variable address is referred to: [Detailed manual/General functions/Address editor/Standard ByteAddress Input](#).

- Synchronize Station No.

After clicking the button “Synchronize Station No.”, the station number will be modified and saved for all addresses of this PLC used in the current project.

- Communication Setting

- Communication Type: RS232, RS485-2 and RS485-4 are optional.
- Baud Rate:
110,300,600,1200,2400,4800,9600,14400,19200,38400,56000,57600,115200 and 187500 are optional.
- Data Bit: the number 7 and 8 are optional.
- Stop Bit: the number 1 and 2 are optional.
- Parity Bit: None, Odd and Even are optional.
- Reset: the default settings will be restored if you click the button “Reset”.
- Advance: more communication protocol parameters can be modified if you click the button “Advance”. The settings are shown as below.

VEDA HCT User Manual

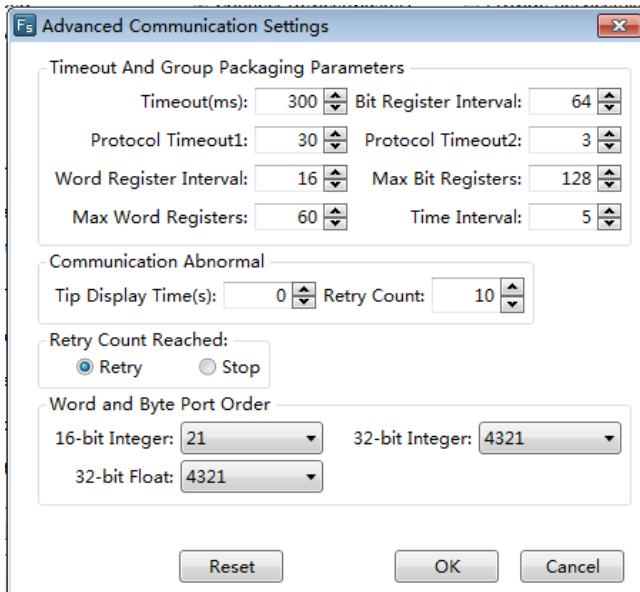

The parameters in the Advanced Communication Settings should not be modified, unless the professional guidance is given. The optional modification may result in a communication failure or unexpected events occur. You can consult the factory technical staff to modify the advanced parameters based on your needs. In most cases, the default parameters are the best and need not to be changed.

4.10.3.1.3 Provide Service (Slave)

The touch screen is used as the slave device.



VEDA HCT User Manual

- Device Type

The Device Type includes Barcode, FLEXEM SLAVE and Modbus RTU Server. It is shown as below.

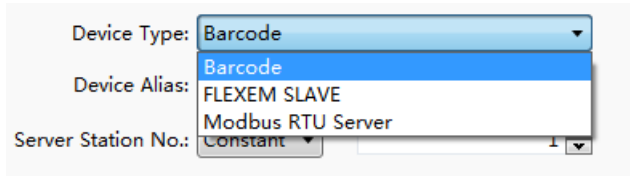

- Device Alias

“Serve” is the default name of the Device Alias.

- Server Station No.

You can set the “Server Station No.” by Constant or Variable. It is the station number of the touch screen as a slave device.

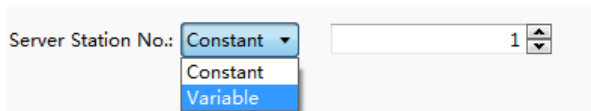

- Constant

The user can input a constant as the fixed station number.

- Variable

You can set the “Server Station No.” by variable. It means the server station number will depend on the value of a variable which you can input by a numeric value input component. The method to input the variable address is referred to: [Detailed manual/General functions/Address editor/Standard ByteAddress Input.](#)

- Communication Setting

- Communication Type: RS232, RS485-2 and RS485-4 are optional.

- Baud Rate:

110,300,600,1200,2400,4800,9600,14400,19200,38400,56000,57600,115200 and 187500 are optional.

VEDA HCT User Manual

- Data Bit: the number 7 and 8 are optional.
- Stop Bit: the number 1 and 2 are optional.
- Parity Bit: None, Odd and Even are optional.
- Reset: the default settings will be restored if you click the button "Reset".
- Advance: more communication protocol parameters can be modified if you click the button "Advance". The settings are shown as below.

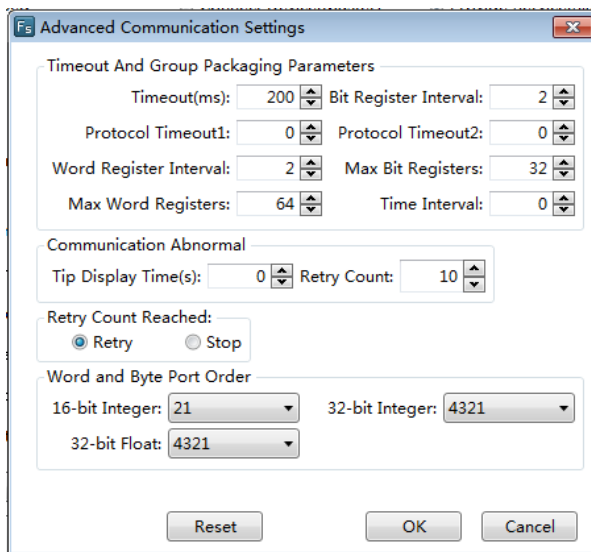

The parameters in the Advanced Communication Settings should not be modified. The optional modification may result in a communication failure or unexpected events occur. You can consult the factory technical staff to modify the advanced parameters based on your needs.

4.10.3.2 Remote Connection

The Remote connection contains three connection modes: "Remote HMI", "Remote PLC" and "Ethernet PLC".

4.10.3.2.1 Remote HMI

After click the menu "Setup / Communication Settings / Remote Connection", the "Remote HMI" settings page is opened as the default. It is shown as below.

VEDA HCT User Manual

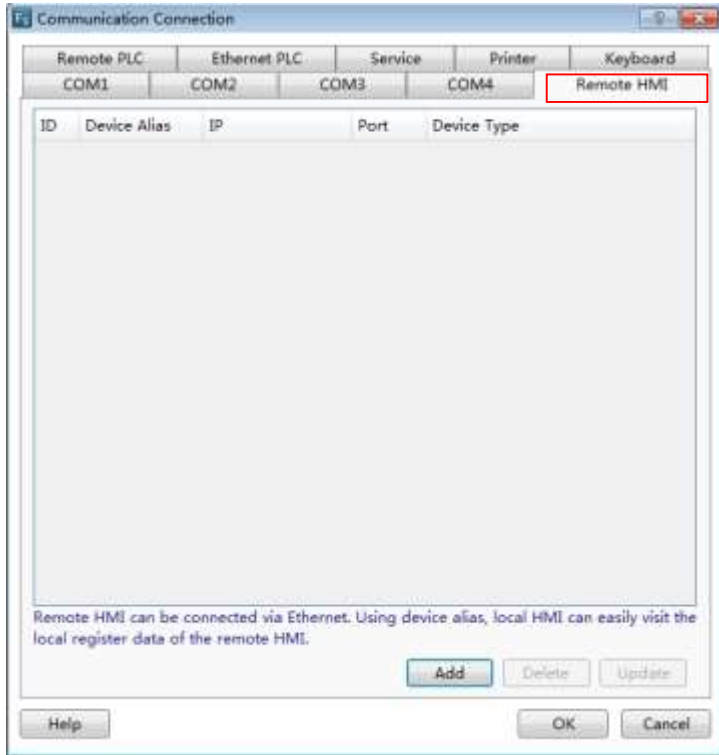

For one of the HMI device, anyone of other HMI devices in the same Ethernet network of the LAN is the Remote HMI. For example, there are two HMI: one named HMI1, another one named HMI2. These two HMI devices are connected in an Ethernet network. For HMI1 device, HMI2 is the "remote HMI" of HMI1. For HMI2 device, HMI1 is the "remote HMI" of HMI2.

After clicking the button "Add" in the "Remote HMI" settings page, the "Remote HMI" settings dialog will pop up. It is shown as below.



- Use IP

VEDA HCT User Manual

You can set the IP address of the remote HMI by Fixed or Variable. The default setting mode is “Fixed”. And the default fixed IP address is “192.168.0.1”. For example, the IP address of HMI1 is “192.168.0.10” and the IP address of HMI2 is “192.168.0.20”. For the project of HMI1, you need set the IP address of the remote HMI “192.168.0.20”.

When you set the IP address of the remote HMI by Variable, a word register address needs to be given as the start address. There are 4 word registers which is from the start word register. They are used to save the 4 segments of the IP address. It is shown as below.

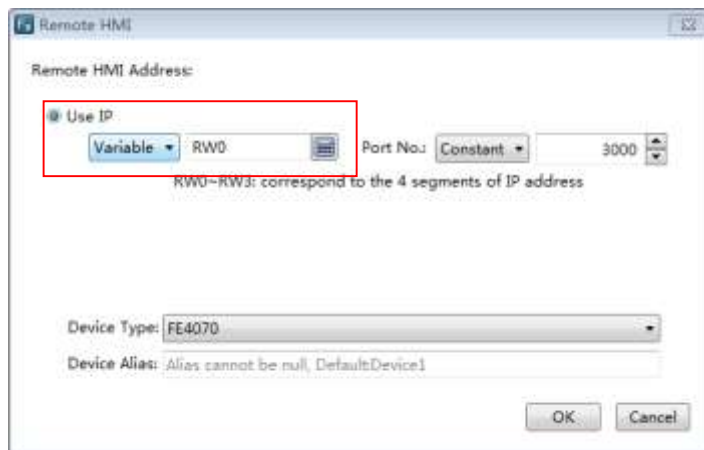

You can input the IP address of the Remote HMI to the 4 word registers by the numeric value input component. Then you can access the desired HMI device.

- **Port No.**

You can set the “Port No.” of the remote HMI by Constant or Variable. The default setting mode is “Constant” and the default port number is 3000. You need to set the “Port No.” by Variable if you want to change the port number of the remote HMI by a word register. The default port number is suggested usually. It is noted that all the port numbers of the connected HMI devices must be the same. Otherwise, the connection may fail.

- **Device Type**

The Device Type refers to the type of the remote HMI device which the HMI needs to access.

- **Device Alias**

The default of the Device Alias is "Device1". It cannot be null. You can set a device alias which is easy to understand, such as "HMI for Machine 3".

VEDA HCT User Manual

Click the button "OK" to confirm the settings. And the "Remote HMI" settings page is shown as below.

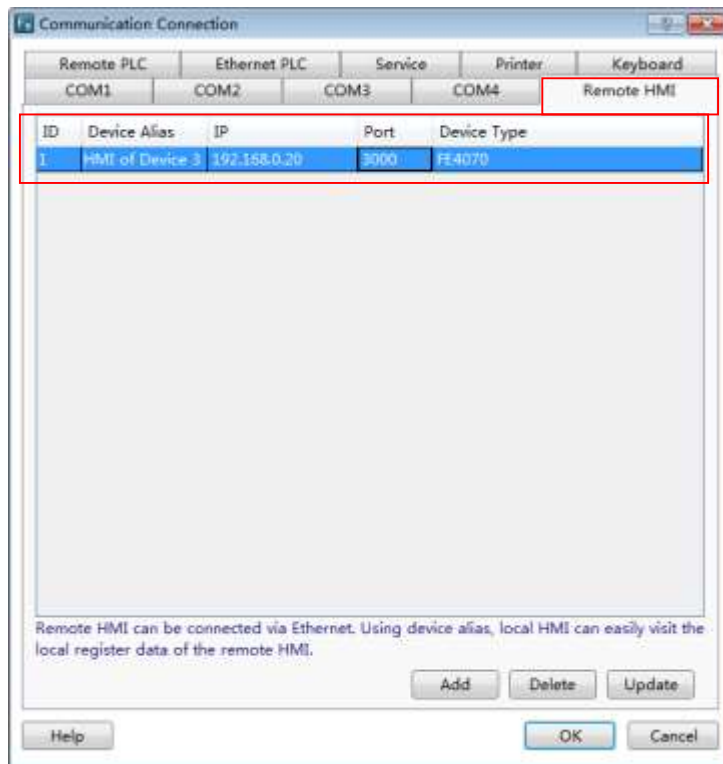

Click the button "OK" in the "Remote HMI" settings page to save, and then you can find the remote HMI device in the Device list of the register address. For example, it is shown as below.

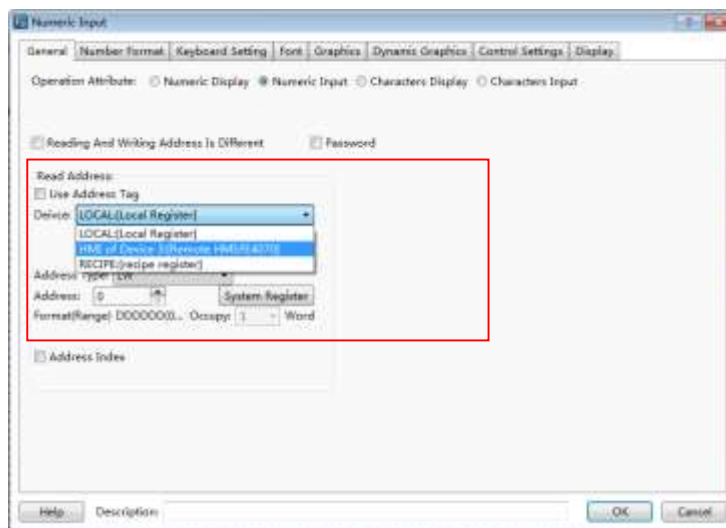

After finishing setting the "Remote HMI", the local HMI can access all the registers of the "Remote HMI", including the LW, RW, SRW, LB, SRB and other registers.

VEDA HCT User Manual

If you need to add other remote HMIs, you can add them by referring to the above.

4.10.3.2.2 Remote PLC

The Remote PLC refers to the device which is connected with the remote HMI, including the PLC, the inverter, the servo, the instrument, and so on.

After clicking the menu "Setup / Communication Settings / Remote Connection", the "Remote HMI" settings page is opened as the default. Click the "Remote PLC" tab to open the "remote PLC" settings page. It is shown as below.

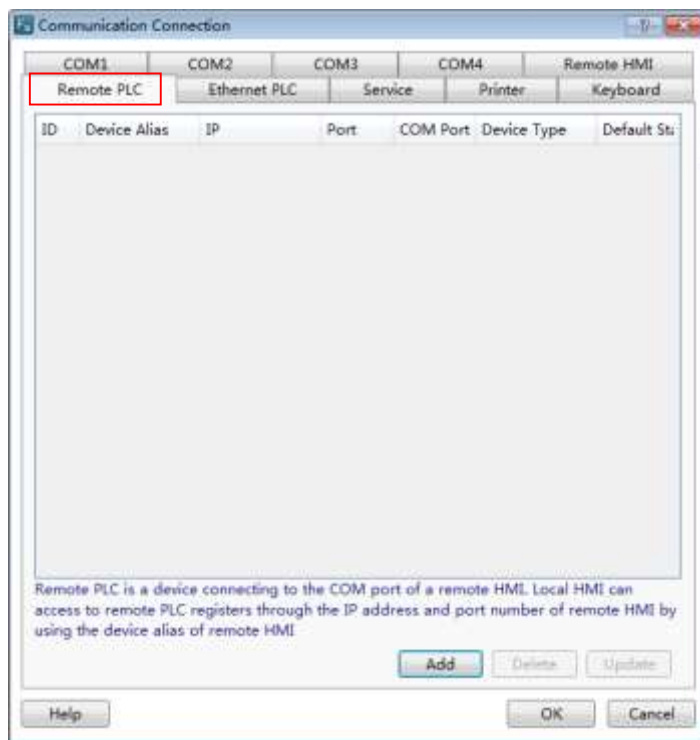

After clicking the button "Add" in the "Remote PLC" settings page, the "Remote PLC" settings dialog will pop up. It is shown as below.

VEDA HCT User Manual

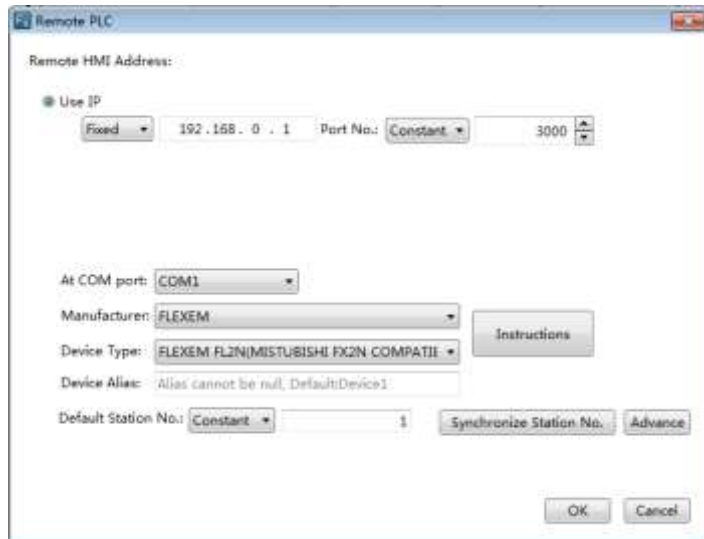

- **Remote HMI Address**

- **Use IP**

You can set the IP address of the remote HMI by Fixed or Variable. The default setting mode is “Fixed”. And the default fixed IP address is “192.168.0.1”.

- **Port No.**

You can set the “Port No.” of the remote HMI by Constant or Variable. The default setting mode is “Constant” and the default port number is 3000.

The detailed settings of “Use IP” and “Port No.” can be referred to the settings in the "Remote HMI" settings page.

- **COM**

- **At COM port**

The “At COM port” refers to the number of COM port which the “Remote PLC” device is connected to. The default is COM1. For example, the “At COM port” is set COM2 if the accessed controller is connected to the COM2 port.

- **Manufacturer**

The “Manufacturer” refers to the manufacturer of the connected "Remote PLC" device.

- **Device Type**

VEDA HCT User Manual

The Device Type refers to the type of the remote PLC device which is connected to the remote HMI.

➤ Device Alias

The default of the Device Alias is "Device1". It cannot be null. You can set a device alias which is easy to understand, such as "HMI for Machine 3".

➤ Default Station No.

The "Default Station No." refers to the station number of the Remote PLC device. It must be consistent with the actual station number of the Remote PLC device.

➤ Advance

Please refer to the "Advance" settings of the "Local Connection".

For example, the "Remote PLC" device is connected to the "Remote HMI" which the IP address is "192.168.0.20". The type of the remote PLC is Siemens S7-200 and the COM1 of the remote HMI is used to connect with the PLC. The station number of the PLC is 2. The settings are shown as below.

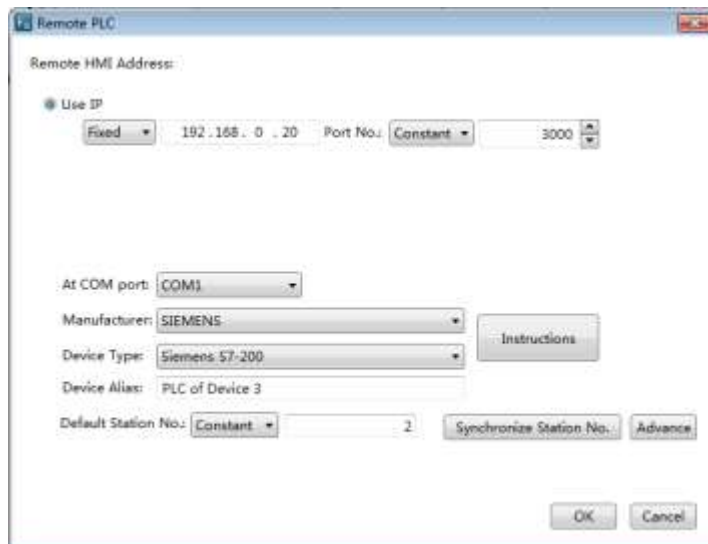

Click the button "OK" to confirm the settings and the "Remote PLC" device is added to the "Remote PLC" settings page.

VEDA HCT User Manual

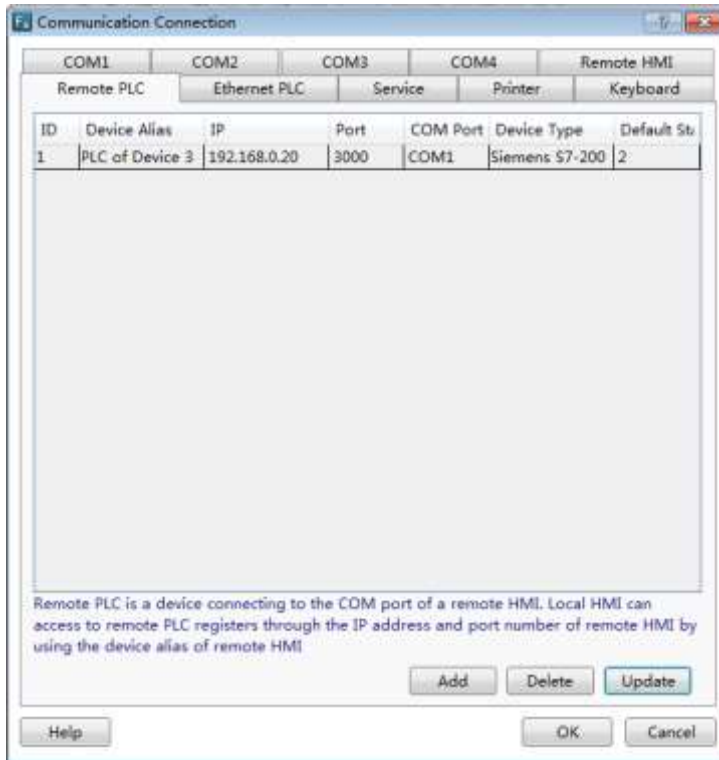

You can find the remote PLC device in the "Device Type" of the component. For example, it is shown as below.

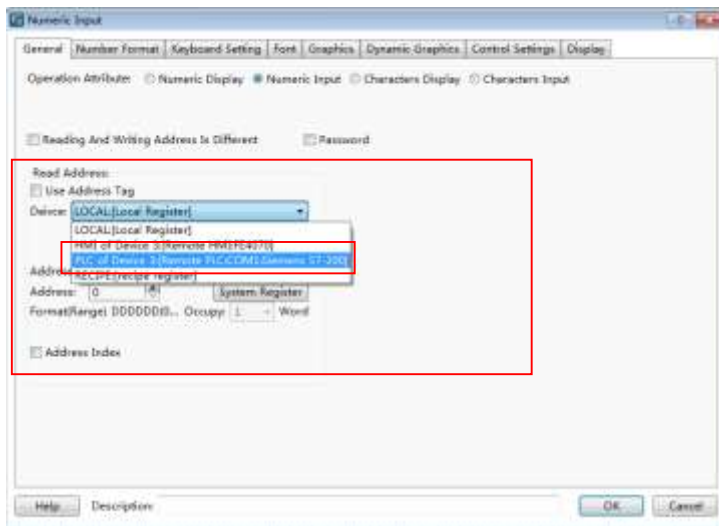

After finishing setting the "Remote PLC", the local HMI can access all the registers of the "Remote PLC" which is connected to the "Remote HMI".

If you need to add other remote PLCs, you can add them by referring to the above.

4.10.3.2.3 Ethernet PLC

VEDA HCT User Manual

The "Ethernet PLC" refers to the PLC which is connected with the HMI by the Ethernet communication mode. The network communication protocols which the HMI and the PLC support are used to complete the communication.

After clicking the menu "Setup / Communication Settings / Remote Connection", the "Remote HMI" settings page is opened as the default. Click the "Ethernet PLC" tab to open the "Ethernet PLC" settings page. It is shown as below.

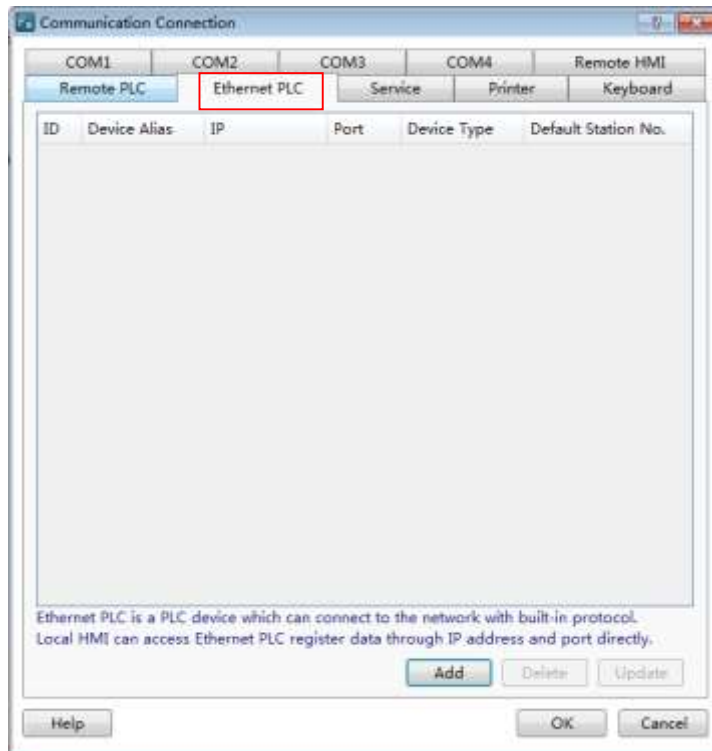

After click the button "Add" in the "Ethernet PLC" settings page, the "Ethernet PLC" settings dialog will pop up. It is shown as below.

VEDA HCT User Manual

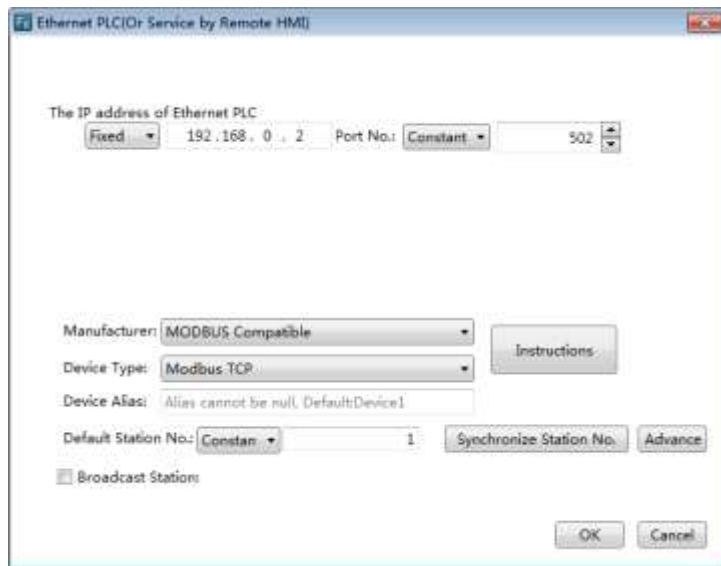

- **The IP address of Ethernet PLC**

The IP address of Ethernet PLC refers to the IP address of the PLC which is connected with the HMI through the Ethernet network.

- **Port No.**

The "Port No." is the number of the communication port between the Ethernet PLC and the HMI. The "Port No." is different for the different network. There is a default "Port No." for your selected network. Generally, it is ok to use the default port number. For example, the default port number is 502 for the "Modbus TCP".

The "Manufacturer", "Device Type", "Device Alias," "Default Station No." are same as the settings in the "Remote PLC".

- **Broadcast Station**

After checking the "Broadcast Station", you can set a number for the broadcast station. The default is that the "Broadcast Station" is not checked. You can determine to use this function or not according to the actual situation.

Click the button "OK" to confirm the settings and the "Ethernet PLC" device is added to the "Ethernet PLC" settings page. For example, the "Modbus TCP" is selected as the device type. The result of settings is shown as below.

VEDA HCT User Manual



If you need to add other Ethernet PLCs, you can add them by referring to the above.

You can realize the connections by using the “Ethernet PLC” mode, such as multi HMIs, multi HMIs and one PLC, multi HMIs and multi PLCs, and other connections.

4.10.3.3 Service

Service refers to that the HMI device provides the data requested by other devices. The HMI is a slave device. The port is static. All communication operations should be initiated by other master devices.

The type of Service includes Serial Port Service and Network Service.

VEDA HCT User Manual

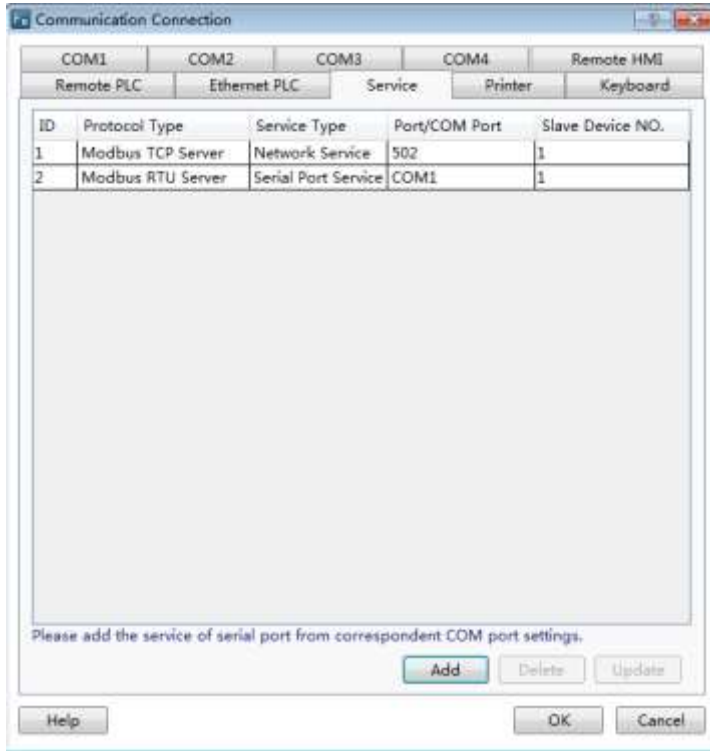

4.10.3.3.1 Serial Port Service



VEDA HCT User Manual

The Device Type can be Barcode, FLEXEMSLAVE and Modbus RTU Server. The Barcode refers to the bar code gun. It can scan information and display it by using a continuous 100 characters saved in the area which LW8900 is the start address. LB8999, which is as a flag bit, is set ON after scanning is finished (it will not be reset automatically). The FLEXEM SLAVE device is supported and the HMI can work as a slave or a master device. The Modbus RTU Server is referred to: [Detailed manual/Setup/Communication Settings/Local Connection/Provide Service \(Slave\)](#).

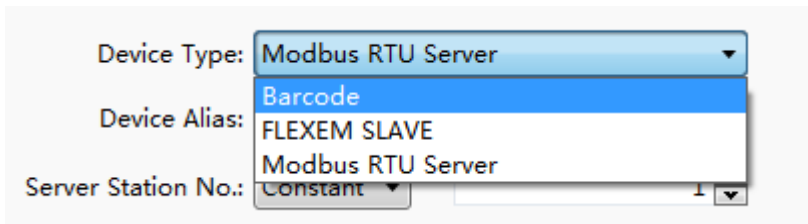

4.10.3.3.2 Network service

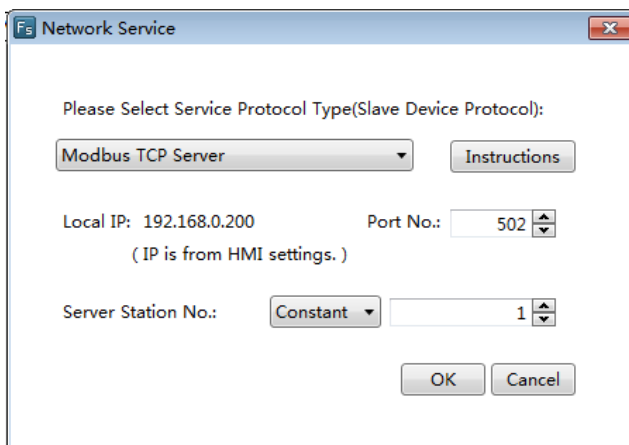

The Service Protocol Type supports Modbus TCP Server. It is referred to: Ethernet Service

4.10.4 Options

The command “Options” in the “Setup” menu opens the Options dialog. You can view and modify some settings such as the VEDA HCT software interface display. There are two catalogs: General and HMI.

4.10.4.1 General

The General has only one option: Auto Update. If the “Check for Updates” is checked in the Auto Update sub catalog, the VEDA HCT software will be checked for updates automatically when it is opened. A message will be popped up to remind you to update if the software detects update packages.

VEDA HCT User Manual

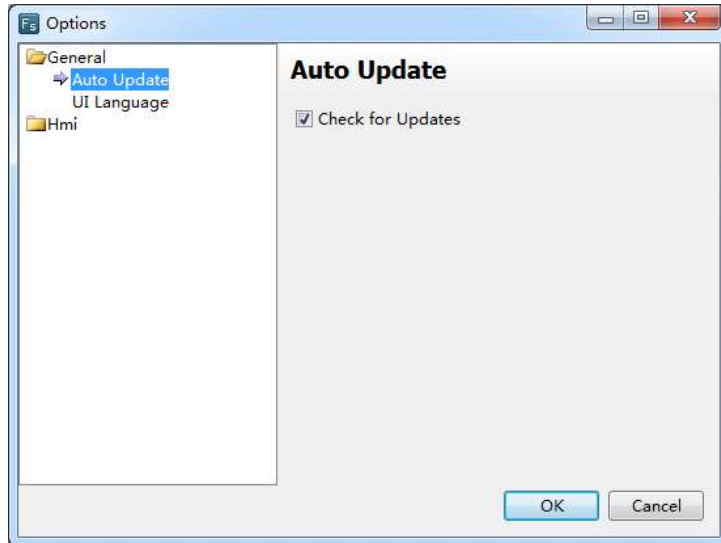

Auto Update: Click this option then the software will update automatically every time you open it, if there is a installation package, it will hint you to install it.

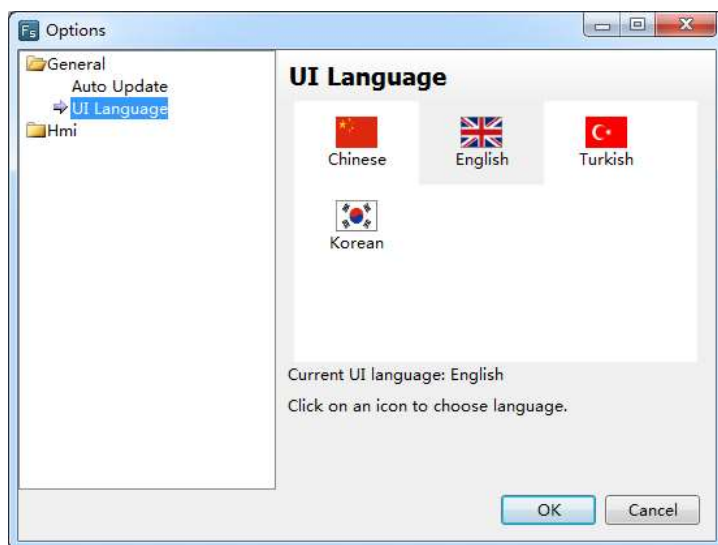

UI Language: You can set the UI language of VEDA HCT, and it will take effect after completing setting and restarting

4.10.3.2 Hmi

The catalog of “Hmi” includes “General”, “Auto Recover” and “Window”.

4.10.3.3.1 General

VEDA HCT User Manual

If you check the “Automatically load the previously closed project” option, the last closed project will be opened automatically when the VEDA HCT software is opened.

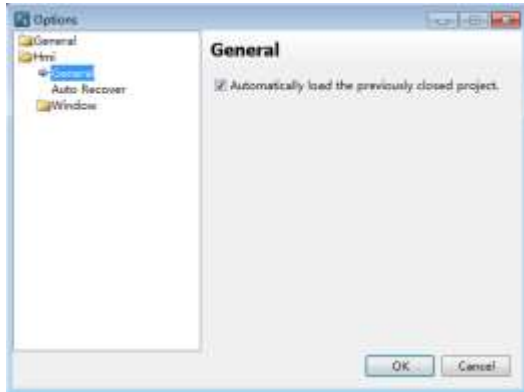

4.10.3.3.2 Auto Recover

You can set the “Recover Time Interval” here. For example, the “Recover Time Interval” is set as 2 minutes means that the project will be saved automatically every two minutes. This setting can reduce the project information losing when the software accidentally shutdown or the power failure is occurred.

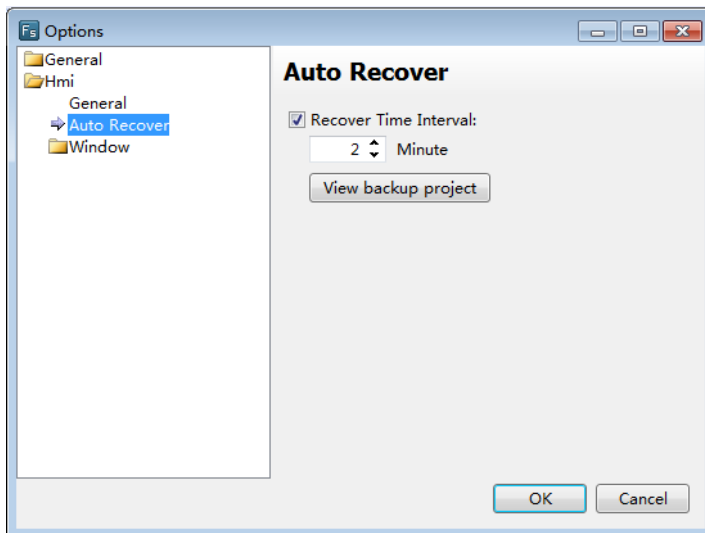

You can open the file folder “Backup Projects” by clicking the button “View backup project”.

VEDA HCT User Manual

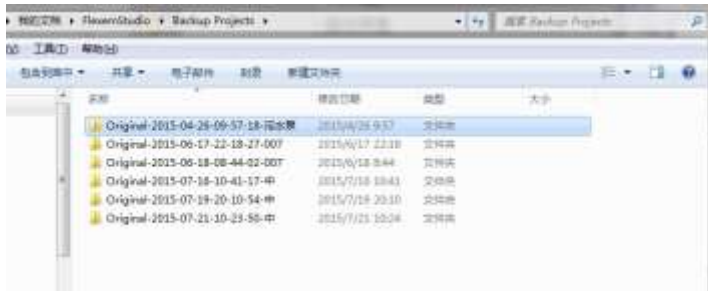

4.10.3.3.3 Window

The sub catalog “Window” includes two options: General and the Designer. The option of “General” is blank.

If you check the “Use pipeline animation effect” in the “Designer” option, you can see the dynamic liquid flow effect in the pipeline component during the project editing process.

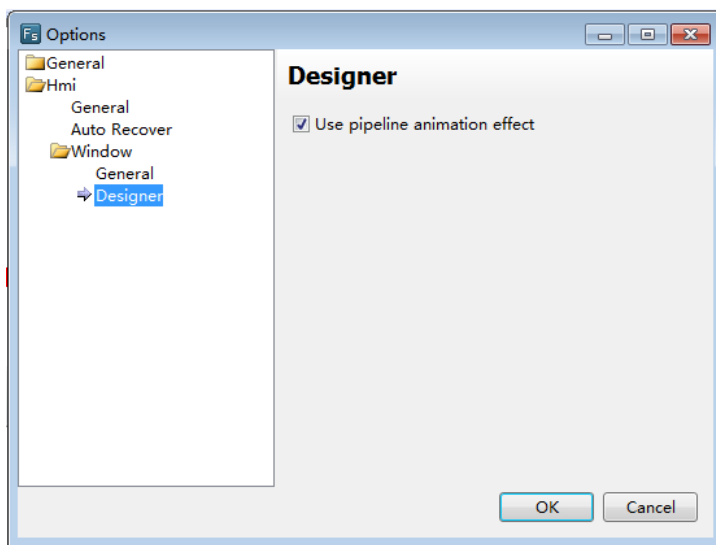

4.11 Tools

In the VEDA HCT software, the Tools menu includes many tools in the shortcut tool bar. It includes” Compile, Compile All, Clear Compile Result, Download, Pack to Disk, Upload, Decompile, and Offline Simulation”.

VEDA HCT User Manual

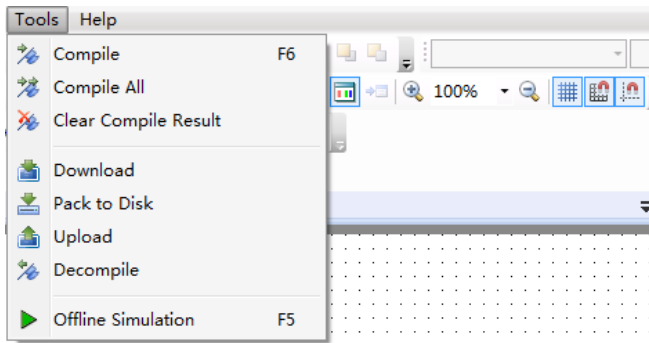

1 Compile

The project will be saved automatically and the system will generate a bin directory and other files if no errors.

2 Compile All

The project will be saved automatically and all the files are forced to compile.

3 Download

The system will compile the project automatically and generate a directory of upload and some relevant files for decompiling. Then the relevant files are packaged and the download tool dialog is popped up. Before clicking the button “Download”, you need to select the communication mode (USB or Ethernet) and the data source (Project or Fpg File). You can check the delete options and check the download options (Batch Mode or Force Mode) according to demands.

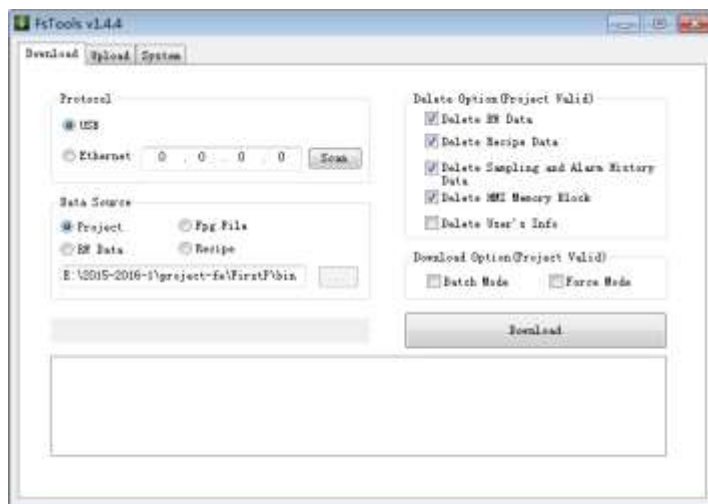

4 Pack to Disk

The tool of “Pack to Disk” can realize compiling the project and packaging it to the disk. The package file is named Fpg File. Then you can download it by the USB disk or the VEDA HCT software.

VEDA HCT User Manual

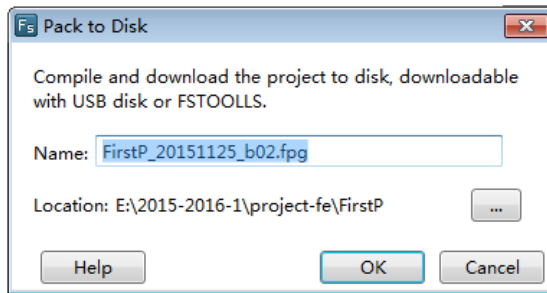

5 Upload

If you check “Upload” to enable upload in the Global Settings of the System Settings, the configuration information downloaded in the HMI device can be uploaded by the USB or Ethernet communication mode. The configuration information can be Project, RW Data, Recipe or Logs.

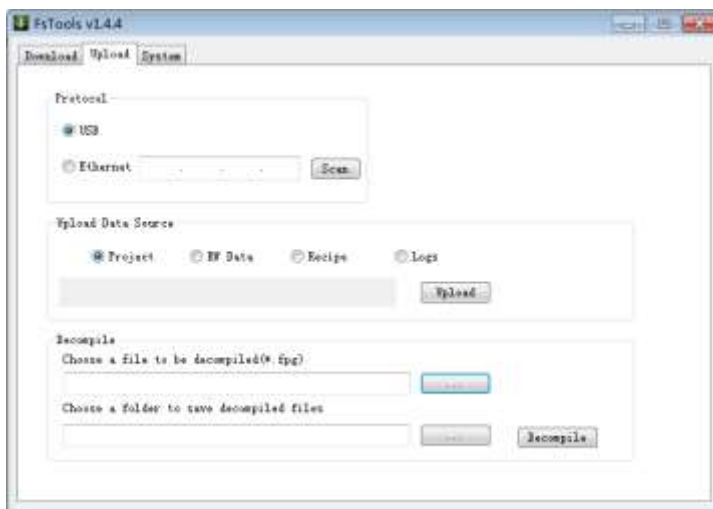
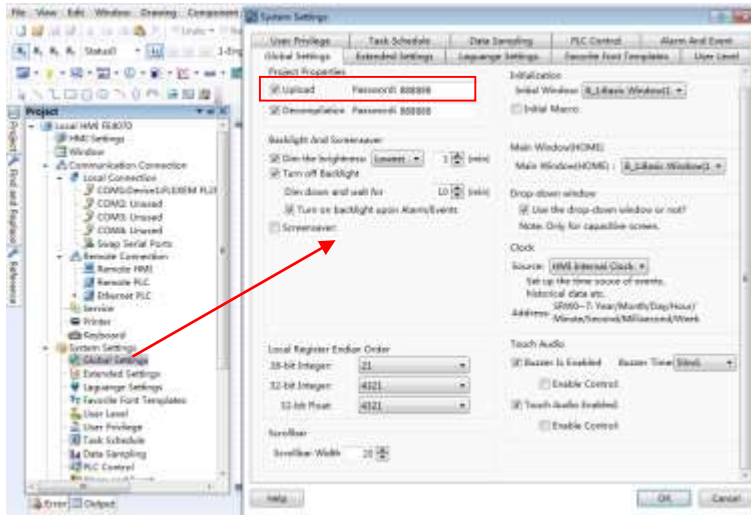

6 Decompile

VEDA HCT User Manual

The Fpg File can be decompiled to project if you check “Decompilation” to enable decompile function in the Global Settings of the System Settings

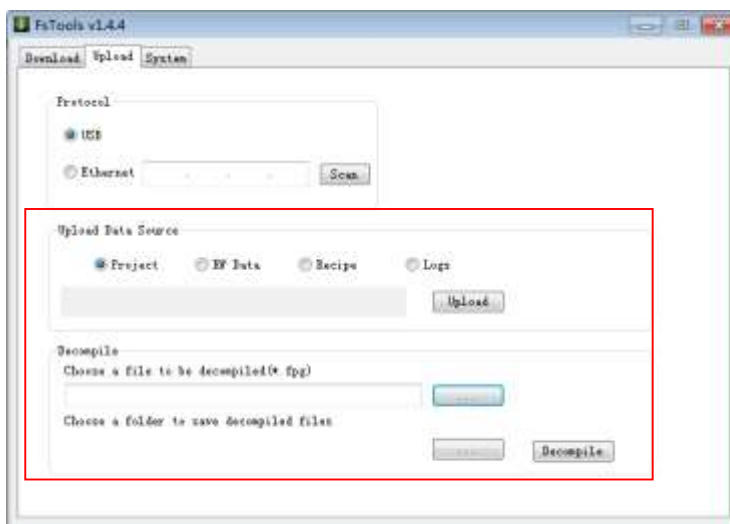
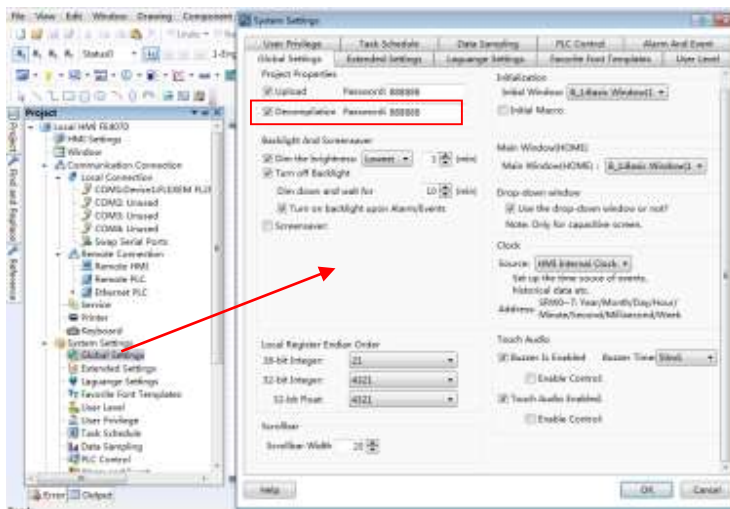

7 Offline Simulation

The tool of the “Offline Simulation” is used to simulate the project running in offline.

4.12 Help

In the VEDA HCT software, the Help menu includes: Online Help, Help, Check for Updates, and About(software version).

VEDA HCT User Manual

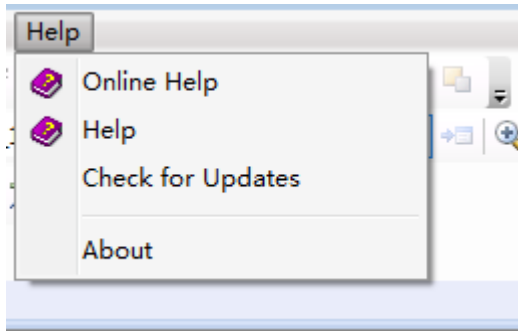

1 Online Help

You can find the online help when you click the command "Online Help".

2 Check for Updates

The VEDA HCT software will be updated by using the internet when you click the menu command "Check for Updates".



3 About

The current VEDA HCT software version information and copyright declaration will be displayed when you click the menu command "About".



4.13 General functions

4.13.1 Address editor

4.13.1.1 Standard Bit Address Input

In the software VEDA HCT, the "Standard Bit Address Input" function will be used frequently. By this function, you can input the bit address which is connected with a

VEDA HCT User Manual

device, and the value of the bit address will be displayed. The function can easily realize the connection with each PLC. The “Standard Bit Address Input” window is as shown as below.

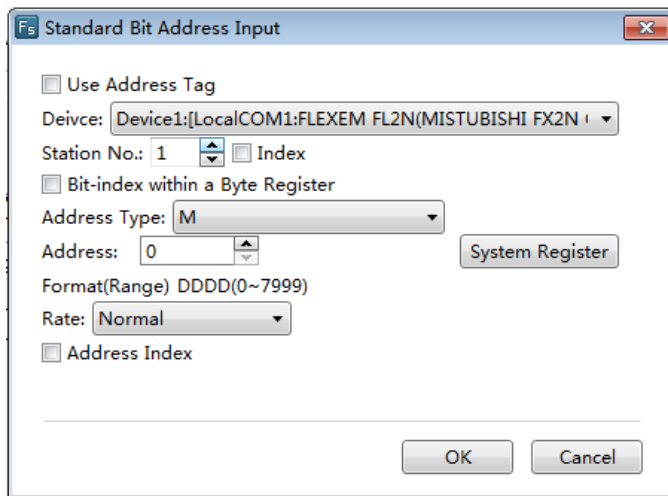

In the VEDA HCT software, the corresponding bit address symbols are given according to the various connected devices. For the Flexem FL2N series PLC, X represents the input address, Y represents the output address, M represents the middle register address, SM represents the system special bit address, and S represents the state address. As shown as below.

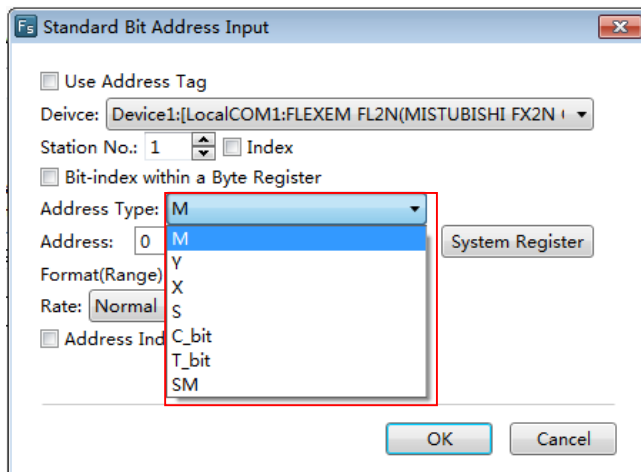

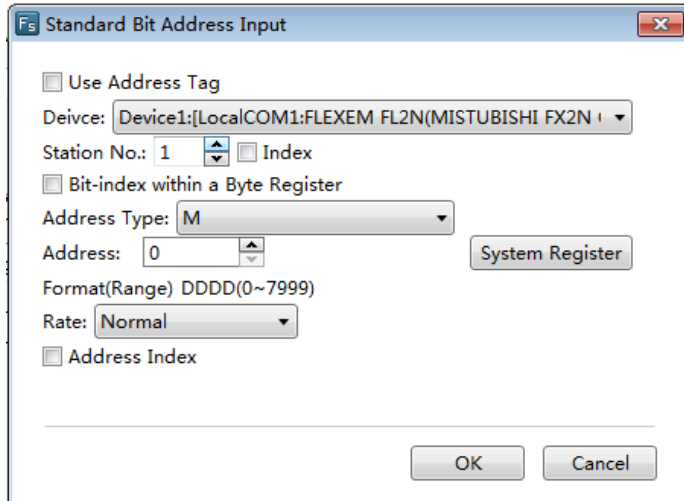

If the address is not connected with the device after you input a specific address number, you should check whether the parameters (such as Device, Station No. and Address) are set correctly. For example, these parameters are set as follows.

VEDA HCT User Manual

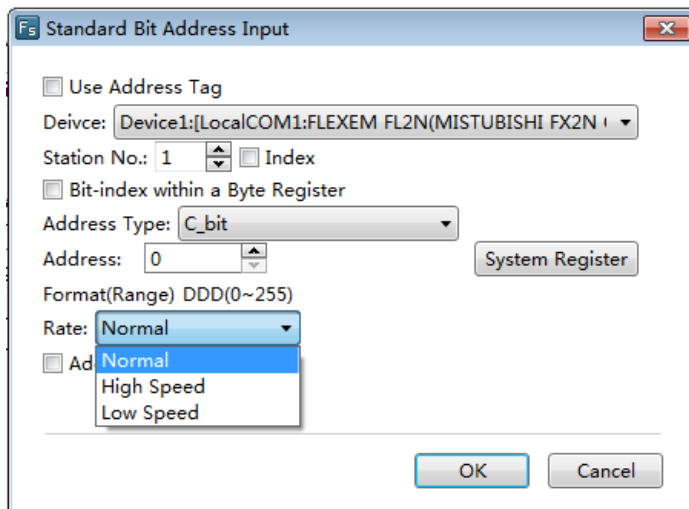

If you find the data refresh rate is a little slow, you can change the communication rate as follows.



Certainly, you can use the address tag library. You need to prepare the data addresses in the address tag library before using them. Check the “Use Address Tag” in the “Standard Bit Address Tag” window and click the button “” to open the “Address Tag Library” window. Select the bit address you need in the address tag library, as shown as follows.

VEDA HCT User Manual

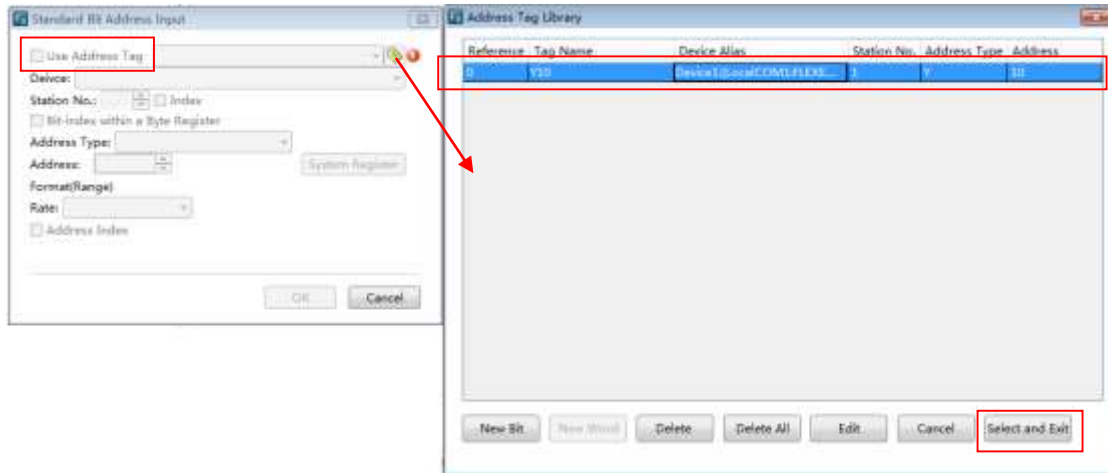

The “Bit-index within a Byte Register” function can be used. You need to check the “Bit-index within a Byte Register”, as shown as below.

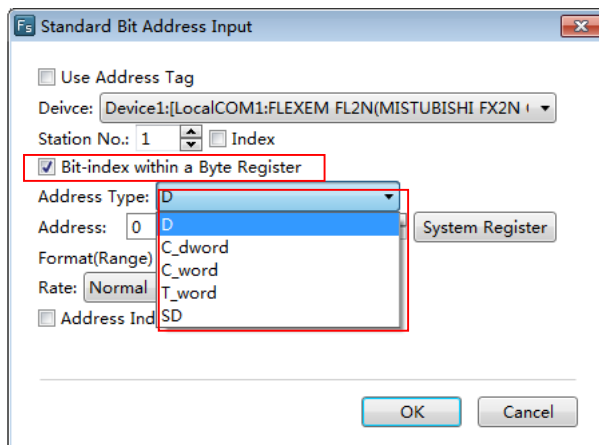

You can use the Address Index function. This function can change the bit address which is connected with the current component according to the value of a word address. For example, the bit address LB0 is connected with the current component. If you check the Address Index and set the address as LW0, as shown as below, the bit address which is connected with the current component will be LB (0 + LW0).

VEDA HCT User Manual

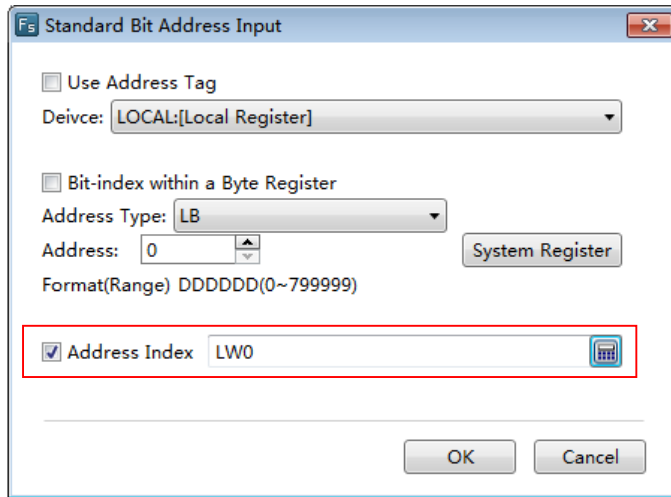

In addition, you can use the System Register in the Standard Bit Address Input window. When you click the System Register button, the System Special Function Register window will pop up. There are many system special function register addresses in this window, as shown as follows. You can quickly select one to use.

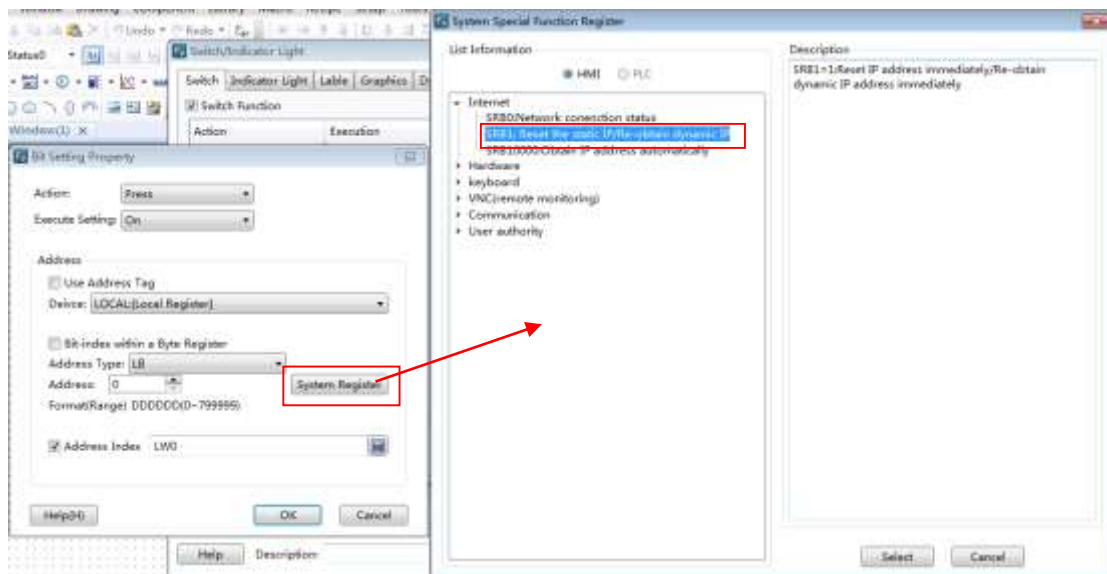

Certainly, the screen is connected with multiple slaves at sometime. The station number is varied. At this moment, you need to use the Index function. This function uses a word address to provide a variable station number. The setting process is shown as follows.

VEDA HCT User Manual

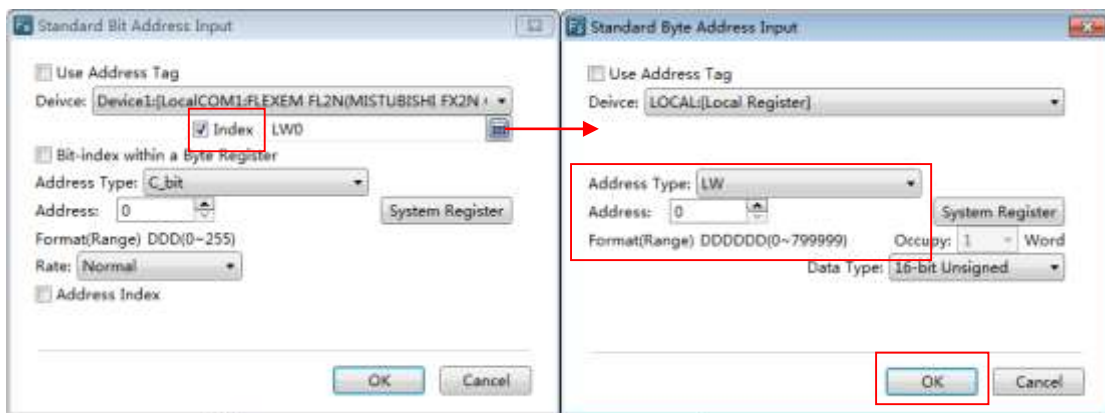
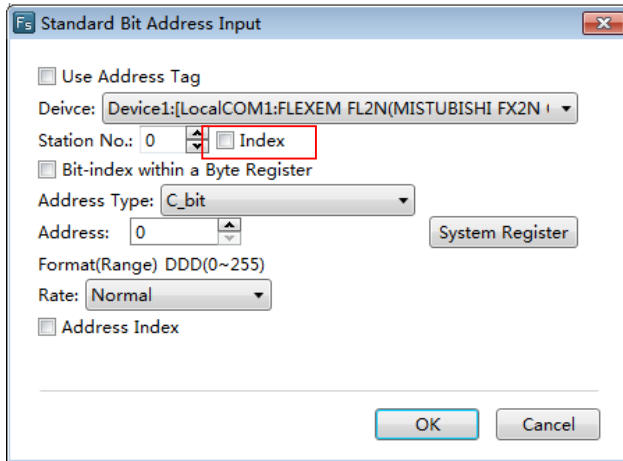

4.13.1.2 Standard Byte Address Input

In the software VEDA HCT, the "Standard Byte Address Input" function will be used frequently. By this function, you can input the byte or word address which is connected with a device and the value of this address will be displayed. The function can easily realize the connection with each PLC. The "Standard Byte Address Input" window is as shown as below.

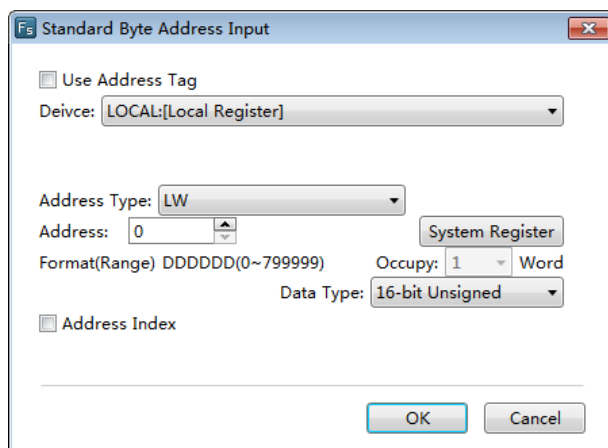

VEDA HCT User Manual

In the VEDA HCT software, the corresponding byte or word address symbols are given according to the various connected devices. For the Flexem FL2N series PLC, D represents the data register, SD represents the special address, represents the timer, C_word represents the 16-bits counter which saves the current value, and C_dword represents the 32-bits counter which saves the current value. As shown as below.

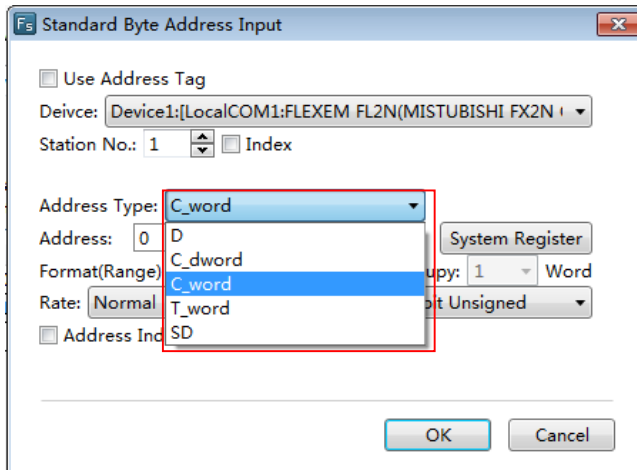

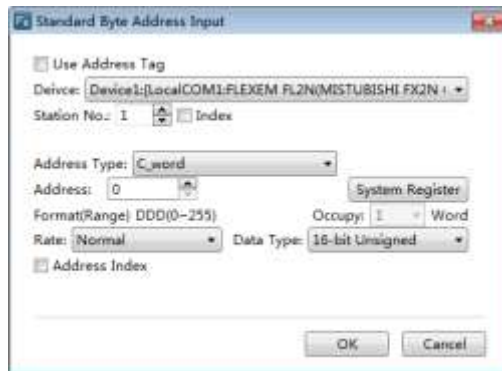

If the address is not connected with the device after you inputting a specific address number, you should check whether the parameters (such as Device, Station No. and Address) are set correctly. For example, these parameters are set as follows.

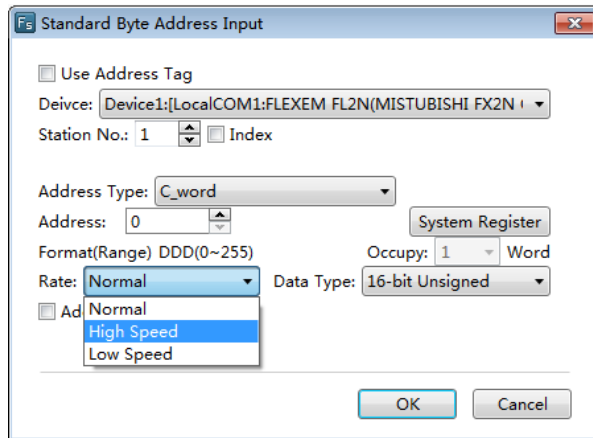

If you find the data refresh rate is a little slow, you can change the communication rate as follows.

VEDA HCT User Manual



Certainly, you can use the address tag library. You need to prepare the data addresses in the address tag library before using them. Check the “Use Address Tag” in the “Standard Byte Address Tag” window and click the button “

Reference	Tag Name	Device Alias	Station No.	Address Type	Address
D0	D0	Device1:[LocalCOM1:FLEXEM FL2N(MISTUBISHI FX2N...	1	C_word	0

You can use the Address Index function. This function can change the byte or word address which is connected with the current component according to the value of a word address. For example, the word address D0 is connected with the current component. If you check the Address Index and set the address as LW0, as shown as below, the word address which is connected with the current component will be D (0 + LW0).

VEDA HCT User Manual

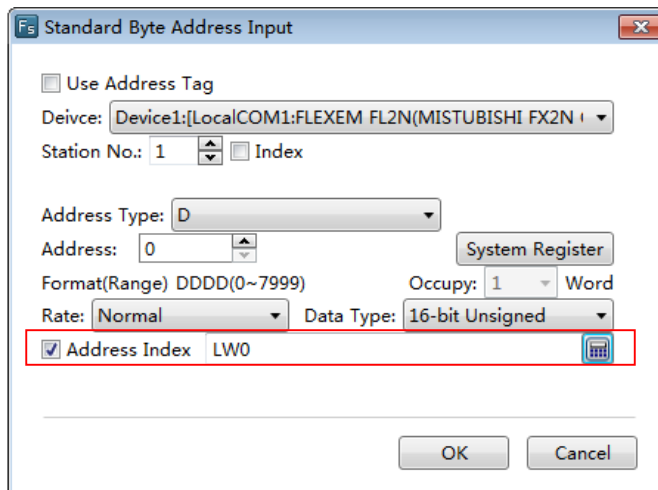

In addition, there are many system special function register addresses. You can quickly select one by clicking the button “System Register”, as shown as follows.

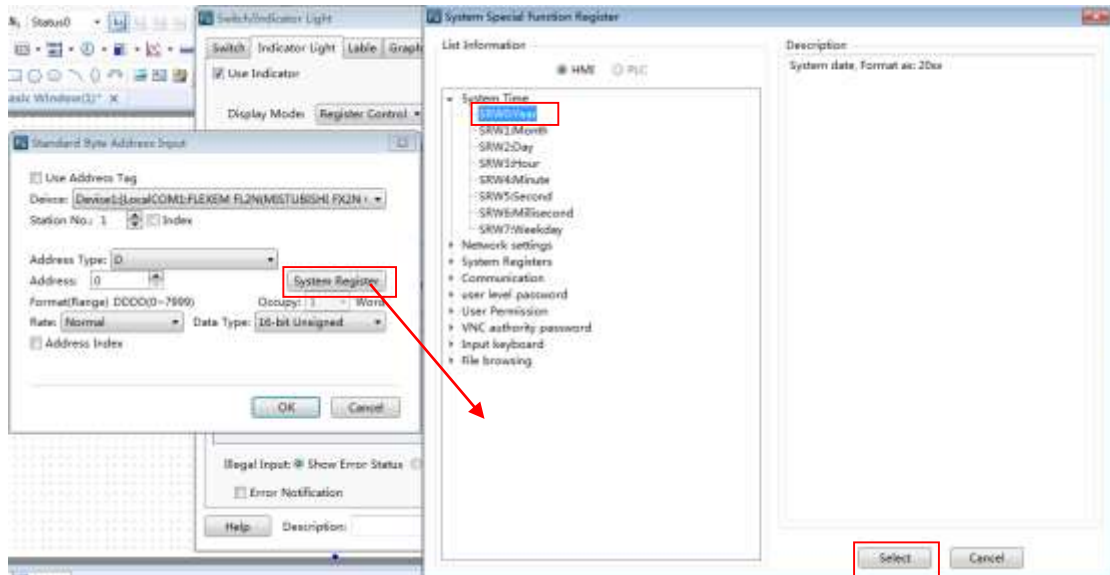

Certainly, the screen is connected with multiple slaves at sometime. The station number is varied. At this moment, you need to use the Index function. This function uses a byte or word address to provide a variable station number. The setting process is shown as follows.

VEDA HCT User Manual

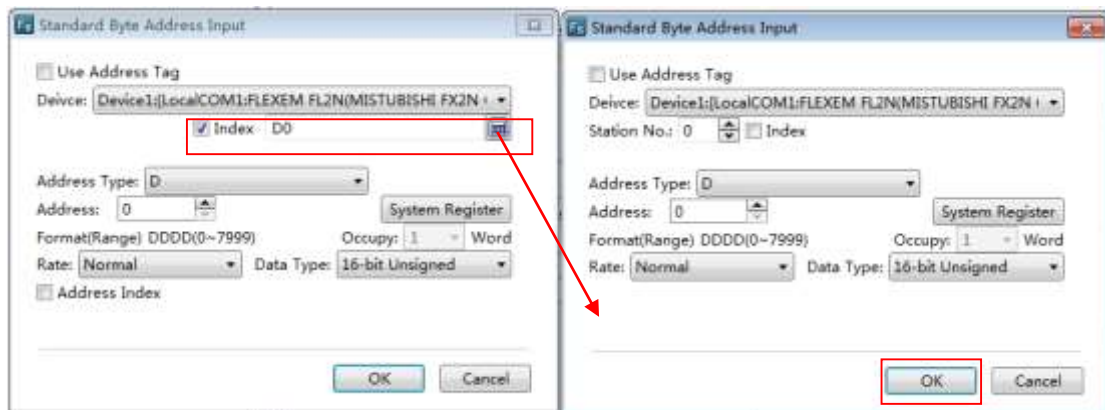
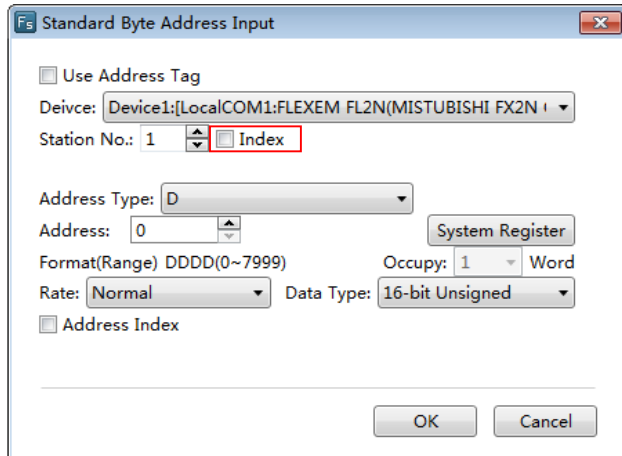

4.13.2 Drawing

4.13.2.1 Border settings

After double-click the figure you have drawn, you can view and select border color and style.

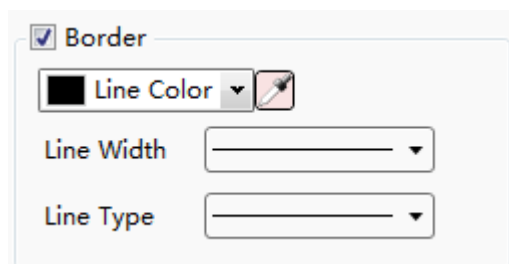

You can select the line width and the line type from the lists.

You can change the border color by using the list or the button “”.

VEDA HCT User Manual

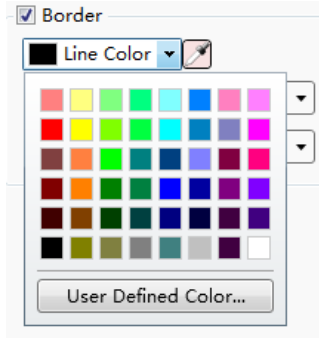

4.13.2.2 Filling settings

After double-click the figure you have drawn, you can view and select the fill type and the fill color.

There are three fill types: Solid Color, Pattern and Gradient.



1 Solid Color

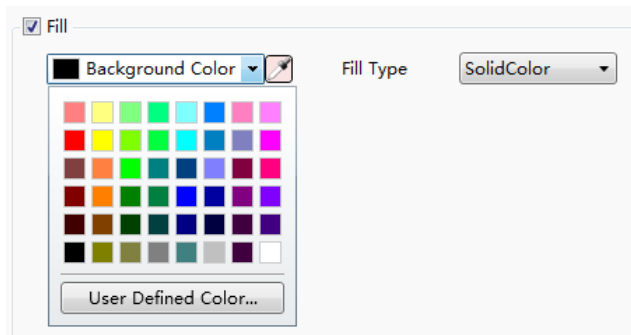

In this fill type, you can select a kind of color for the background of the figure from

the list or by using the tool button “”.

2 Pattern

VEDA HCT User Manual

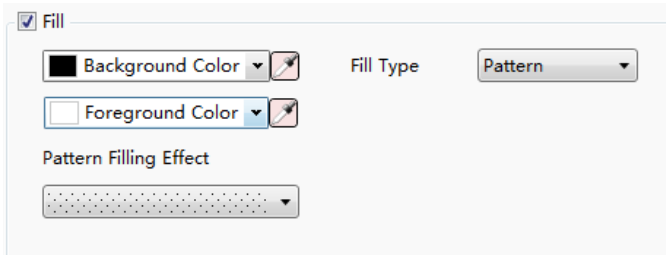

In this fill type, you can select a kind of color for the background and another kind of color for the foreground. You can set the pattern filling effect, too.

3 Gradient

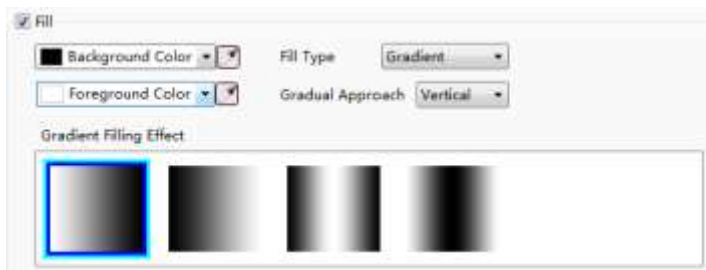

In the gradient fill type, you can select the background color, the foreground color, gradual approach and gradient filling effect.

4.13.3 Font settings

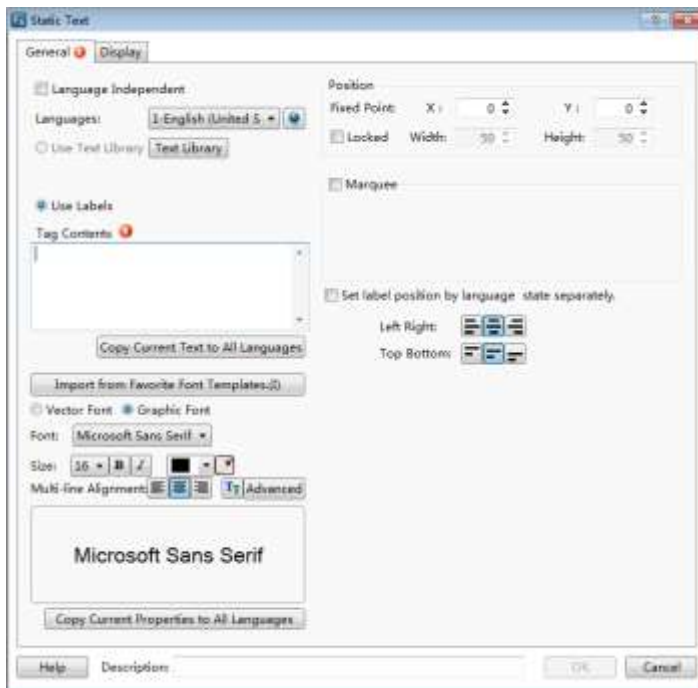

1 Vector Font

VEDA HCT User Manual

According to the font attributes setting, change the characters of the text into a TrueType font file (ttf format) for HMI.

- Disadvantages
 - Only support the TrueType font type (ttf format) which the current operating system has installed.
 - The below is the font effect comparison between the two that the "Disable Vector Font Bordline Blurring Processing" is not checked and the "Disable Vector Font Bordline Blurring Processing" is checked.

Static Text

Static Text

Note: the "Disable Vector Font Bordline Blurring Processing" can be set in the path: Project/Local HMI/System Settings/Extended Settings.

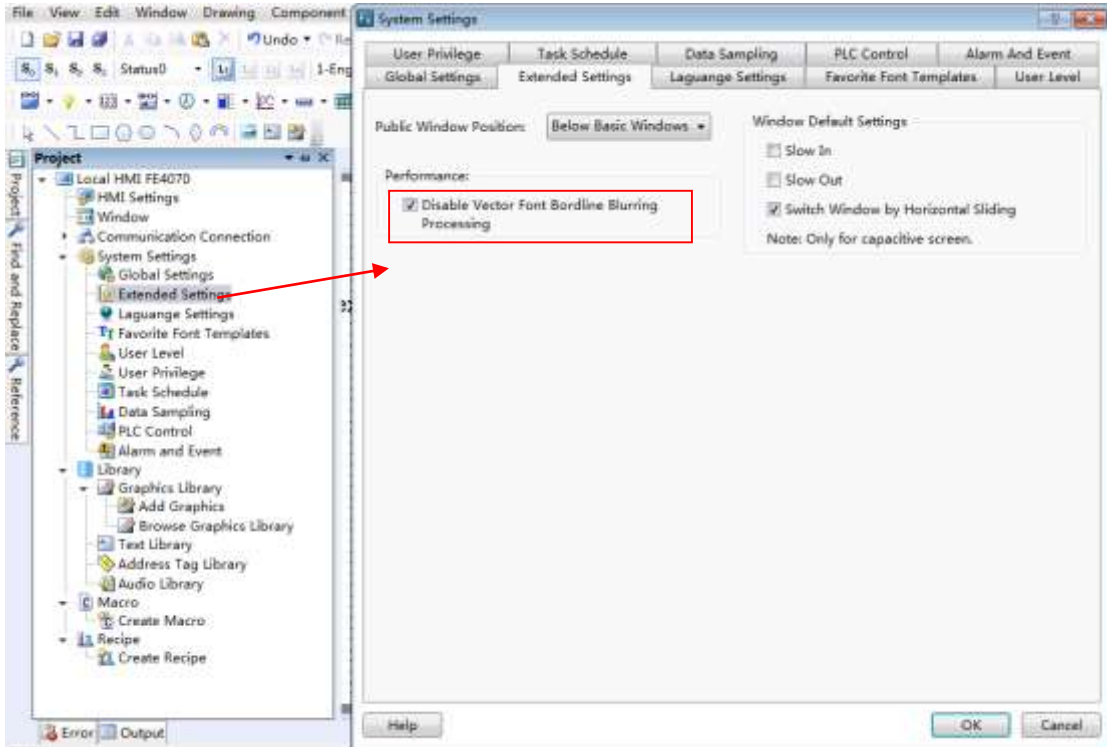

- Advantages
 - Occupy Less memory. The same character in the same font type uses one font data regardless of size, color, bold, or italic.

VEDA HCT User Manual

- Full size and can be set freely without distortion.
- Supports multi-line text alignment.
- Text Library supports the use of vector fonts.

2 Graphical Font

Regard the string as a whole and save it as a bitmap to the project.

- Disadvantages
 - Occupy more memory because of the bitmap storage format.
- Advantages
 - Supports all the fonts installed in the current operating system.
 - Display effect is good.

3 Equivalent width

Each single font displays in the max width size. The max width of the font is greater if the font size is greater.

- For example, the max width of a single digit is 17 and the max width of a single character is 22 if the font size is 16,

4 Font

You can set the font type from the list. It supports all font types installed in the current operating system, such as Microsoft Sans Serif.

5 Size

You can set the current font size. The range is from 8 to 144.

The font supports bold and italic, and you can modify the font color from the

list or by using the tool button .

6 Multi-line Alignment

It is only valid for multiple lines text. You can set the multiple lines text align to the left, center or right.

7 Advanced

You can set the Horizontal Scaling, Space, and Shadow Effects after clicking the button "Advanced".

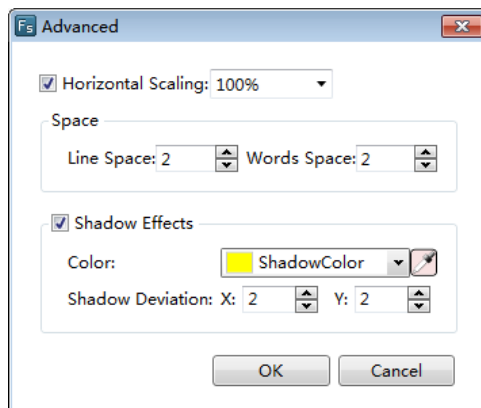

8 Position

You can set the font position of the current components.

4.13.4 Graphic edit

VEDA HCT User Manual

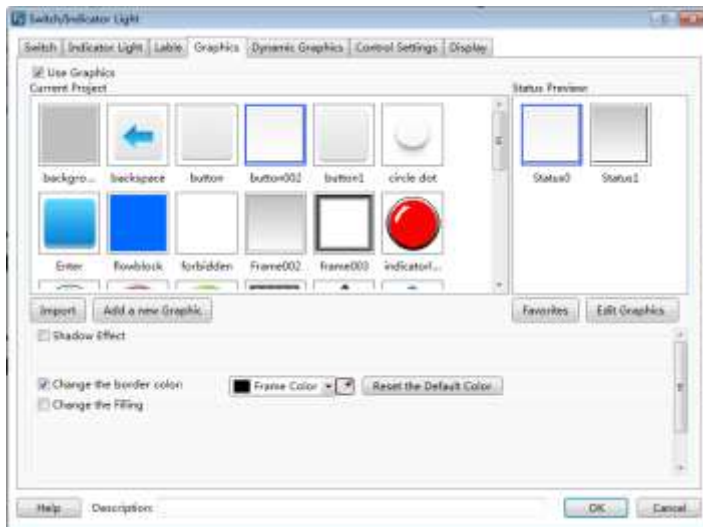

1 The Current Project Graphics Library

For some components, you can find the property TAB of “Graphics”. In this TAB, you can view the component graphics in the Current Project Graphics Library. Select one, then you can preview the status of it in the Status Preview window.

2 Import

The system graphics library can be opened by clicking the button “Import”. You can select a system graphic into the current project graphics library here.

3 Add a new Graphic

Click the button “Add a new Graphic” to pop up the window “Add New Graphics” (see Figure a). Then you can set the properties of the new graphic, such as “Name”, “Status Count”, “Width”, “Height” and other information. After clicking the button “OK” to confirm it and closing all the pop-up windows, you can see that an editable window with the same name is already opened (see Figure b). You can edit the new graphic in this window. Refer to: **Detailed manual/Library/Graphics Library/Add graphics.**

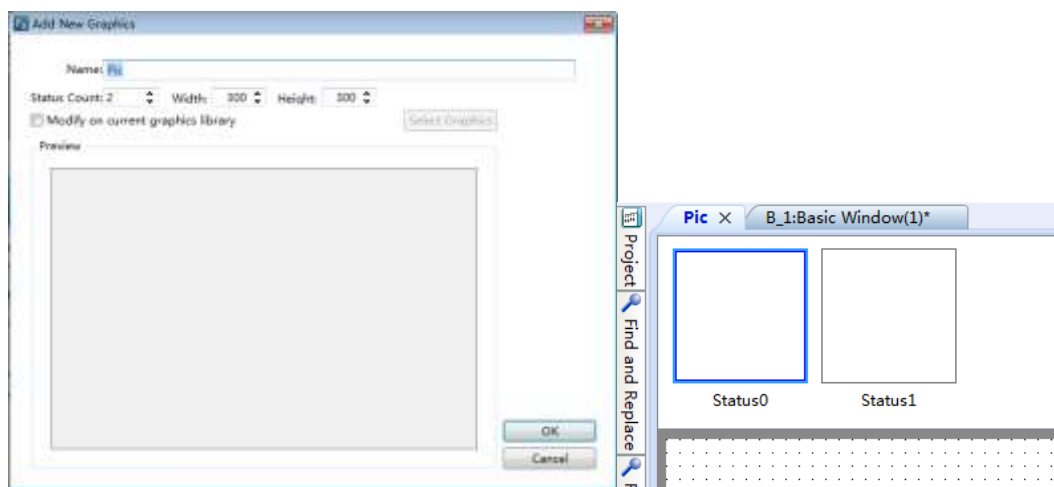

4 Favorites

VEDA HCT User Manual

After clicking the button “Favorites”, you can add the current selected graphic to a specified Favorites Category. The Favorites Category can be selected, added and renamed (see Figure a). Click the button “OK” to confirm the addition to the Favorites Category. You can view the graphics collected in the Favorites Category by the path: **Project/ Library/Graphics Library/Browse Graphics Library** (see Figure b).



a



b

5 Graphics Edit

After clicking the button “Edit Graphics” and closing all the pop-up windows, you can see that an editable window with the same name of the graphic is already opened (see Figure a). The graphic can be edited in this window. Refer to: **Project/Library/ Graphics Library/Add graphics.**

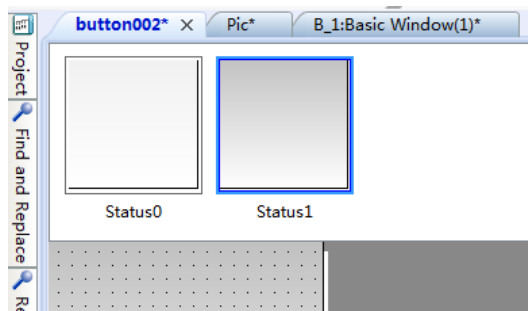

6 Shadow Effect

Double click the graphic you have drawn in the Graphics Edit window to modify the properties of it. After checking the Shadow Effect (see Figure a), you can add the shadow effect for the selected graphic (see Figure b).

VEDA HCT User Manual

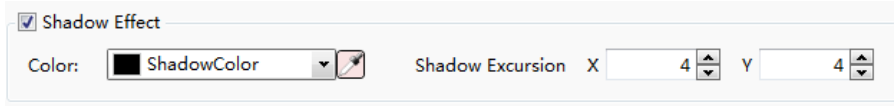

a.



b.

7 Border

You can change the outer border color of the current selected graphic. Note: Only when the elected graphic is vector graphic and this attribute can be modified, this option is valid to change the outer border color (see Figure a)!

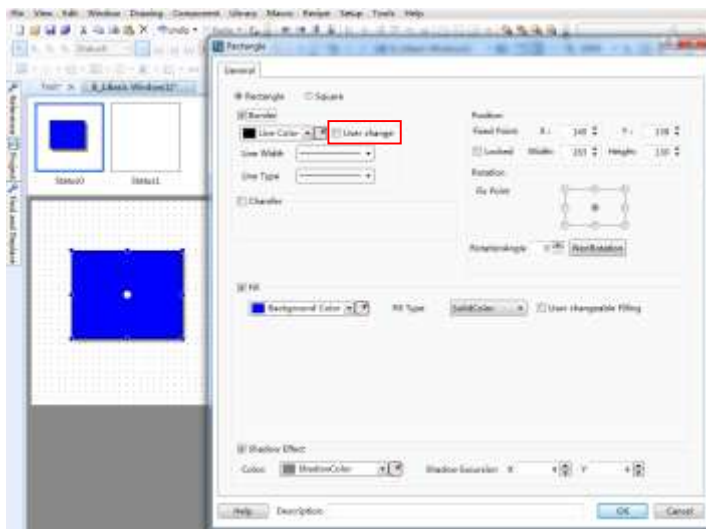

8 Fill

You can change the filling effect of the current selected graphic (see Figure a). Note: Only when the elected graphic is vector graphic and this attribute can be modified, this option is valid (see Figure b)!

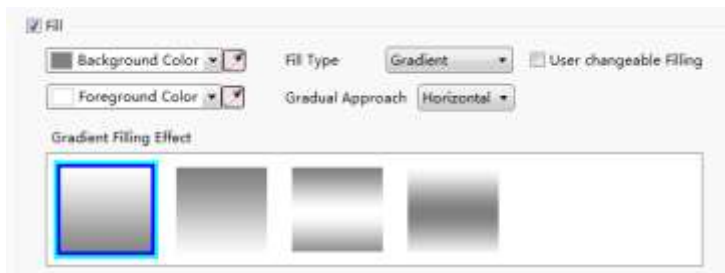

a

VEDA HCT User Manual

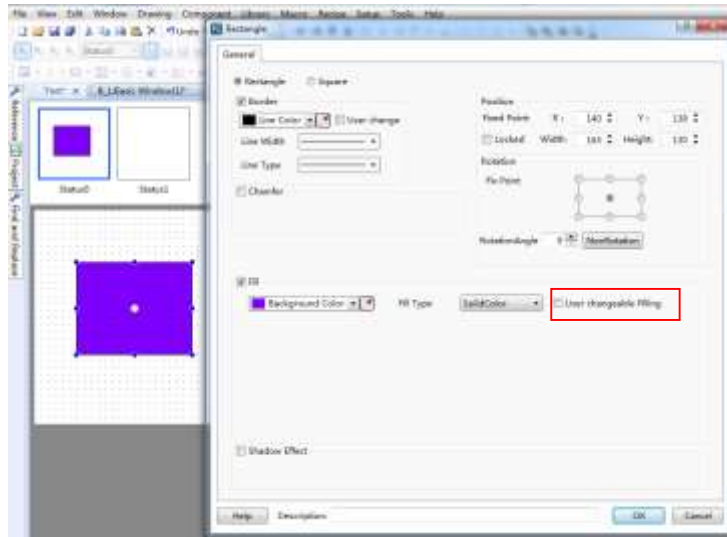

b

4.13.5 Control settings

For some components, there is a property TAB of “Control Settings”.

① Activation Settings

- Always

The current component can always be operated if you use the option “Always”.

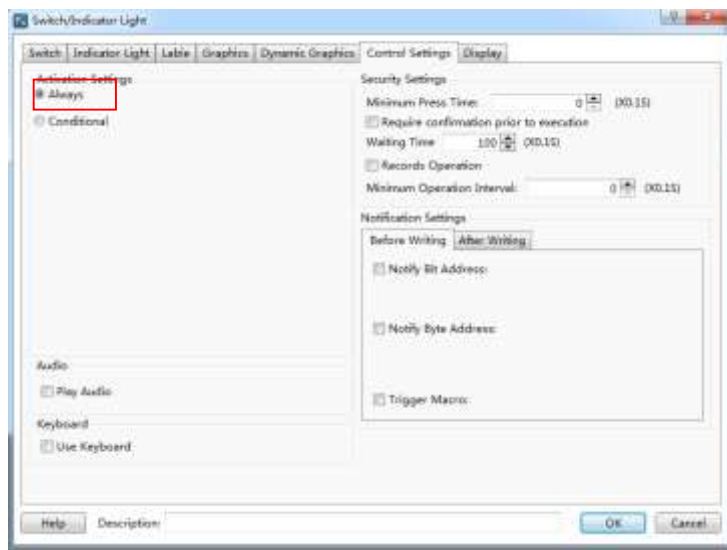

- Conditional
 - Indicating Invalid Mark

VEDA HCT User Manual

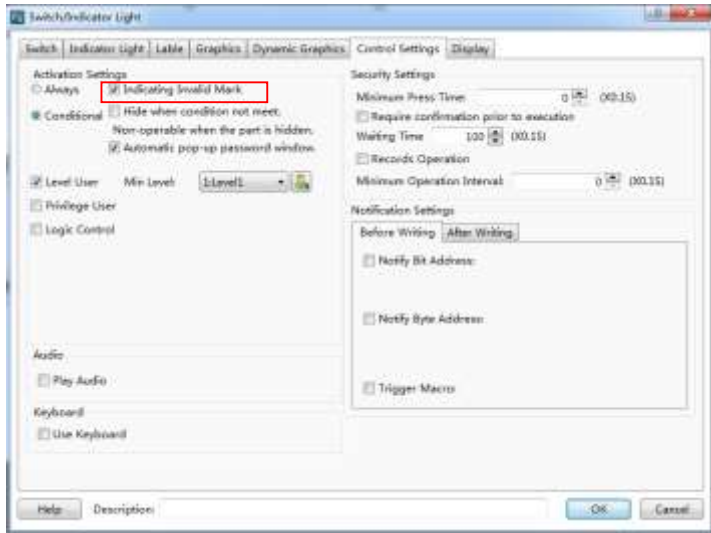

After checking the option “Indicating Invalid Mark”, the prohibited mark will display on the component if the operating conditions are not met. The prohibited mark is shown as below.

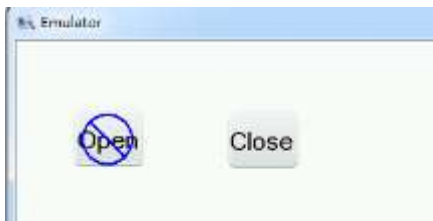

➤ Hide when conditions are not met.

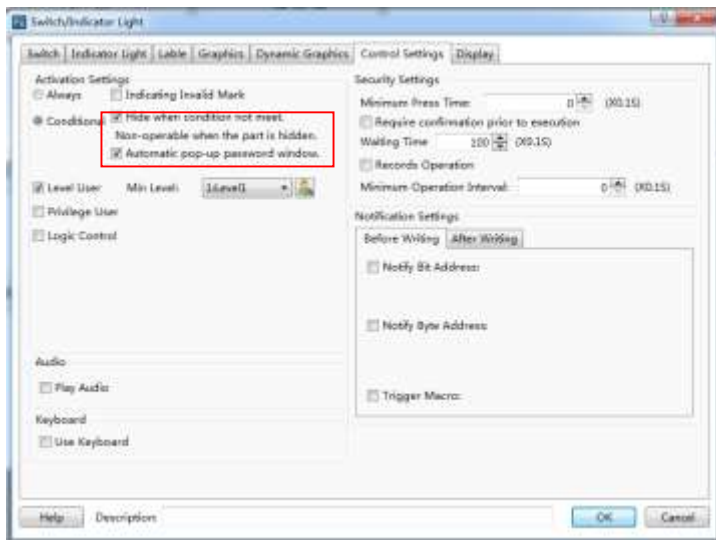

When you check the option “Hide when conditions are not met”, the component will hide if the operating conditions are not met.

➤ Automatic pop-up password window

VEDA HCT User Manual

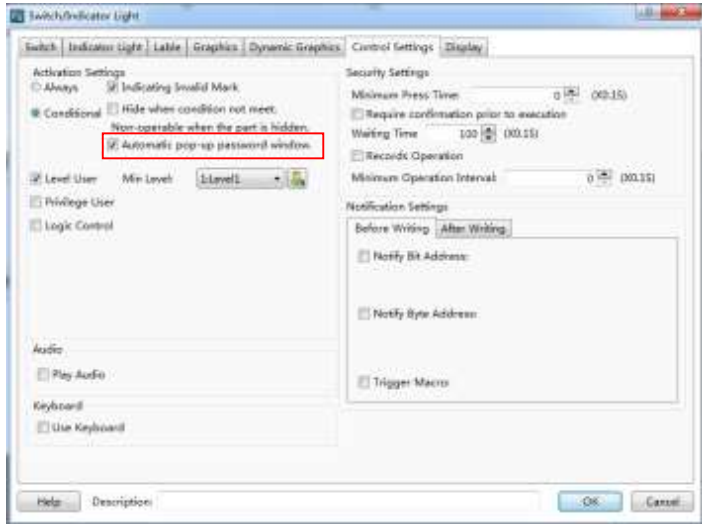

If you check the option “Automatic pop-up password window”, the user login window will pop up when you click the component. It is shown as below.

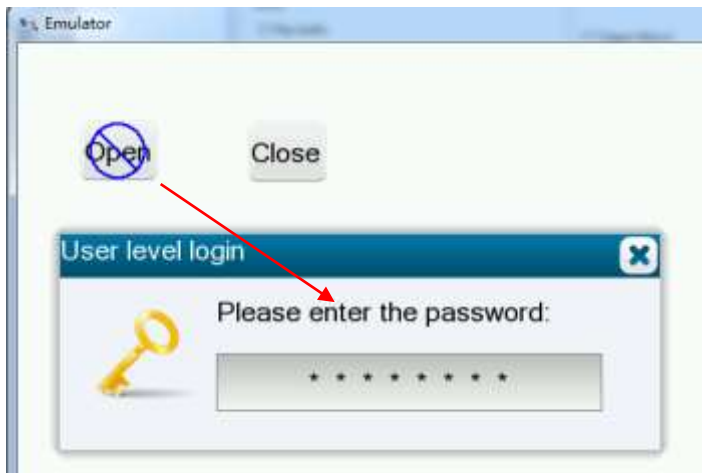

- Level User

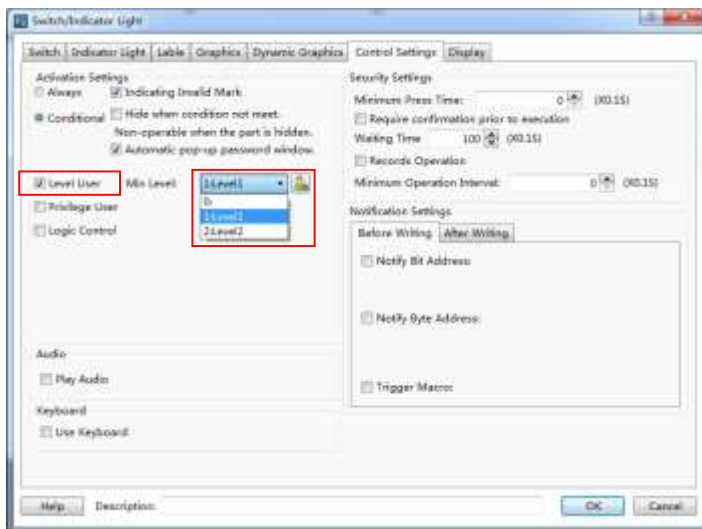

VEDA HCT User Manual

After checking this function, you need to enter the appropriate user level password to operate the device. It is shown as below.



- Privilege User

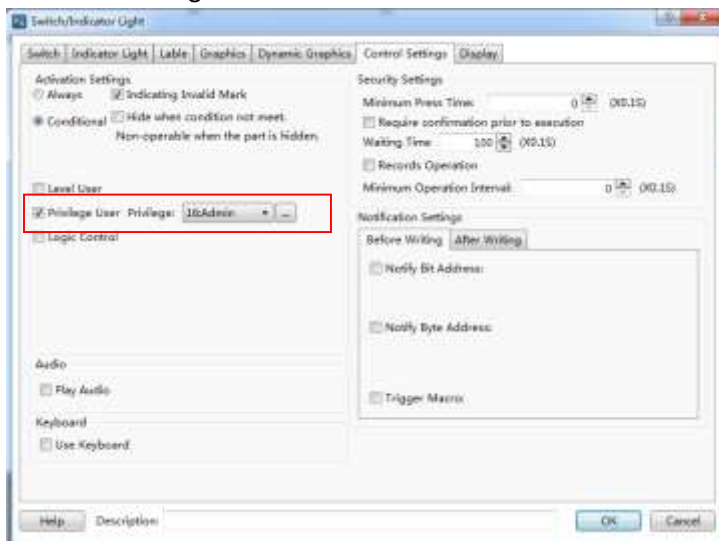

After checking this function, you need to login by using the corresponding user privilege to operate the component. It is shown as below.

VEDA HCT User Manual



- Logic control

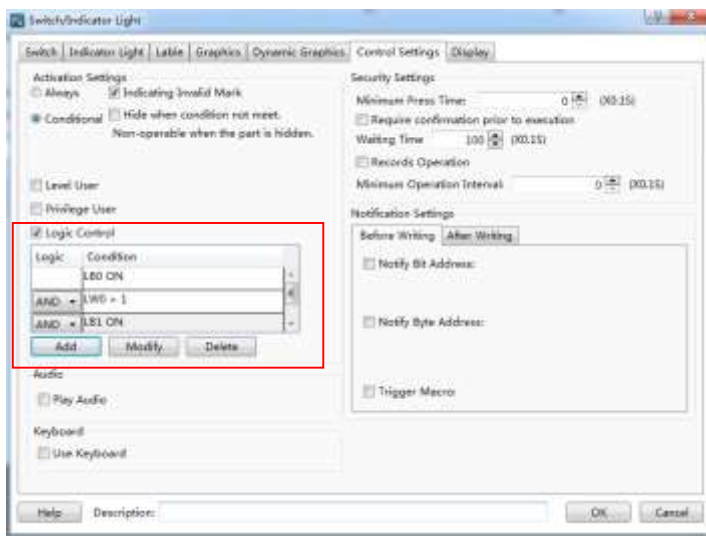

After check this function, the component can be operated when the specified conditions are satisfied. The conditions can be multiple logical operations.

② Security Settings

- Minimum Press Time

VEDA HCT User Manual

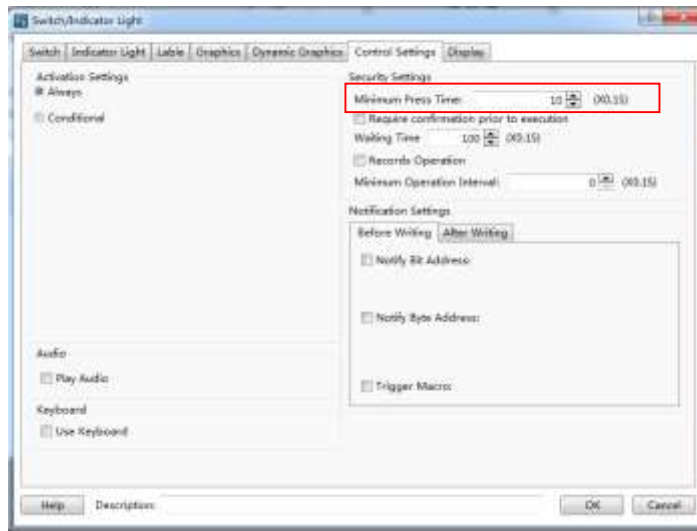

You need to hold the button component for a specified time to perform actions. The function is used to avoid the action due to touching the screen by mistake.

- Require confirmation prior to execution

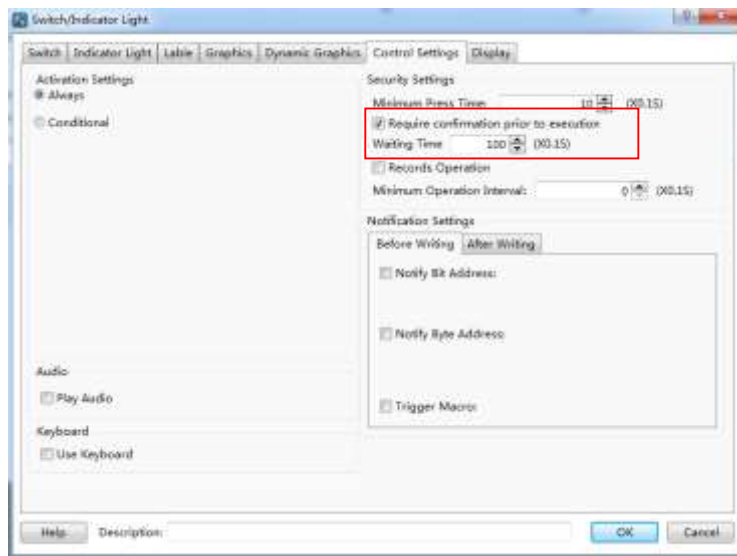

If this function is checked, a confirmation dialog box will pop up automatically. It will keep the display status for the "Waiting Time" if you don't confirm or cancel it. It is shown as below.

VEDA HCT User Manual



- Records Operation

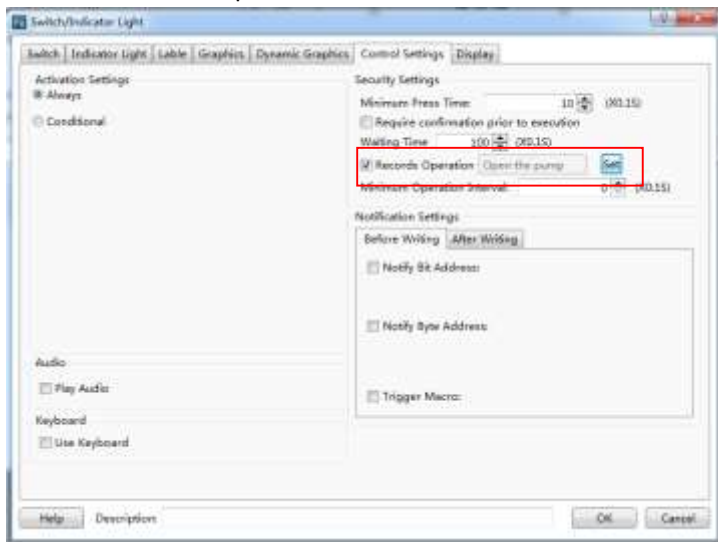

If you check this function, you can record the operations of the component and display the records in the operator Log. It is shown as below.

Serial No.	Date	Time	User Name	Operation Log
3	10/01/16	11:32:02		Open the valve
2	10/01/16	11:31:33		Open the valve
1	10/01/16	11:31:20		Open the valve
0	10/01/16	11:31:17		Open the valve

- Minimum Operation Interval

VEDA HCT User Manual

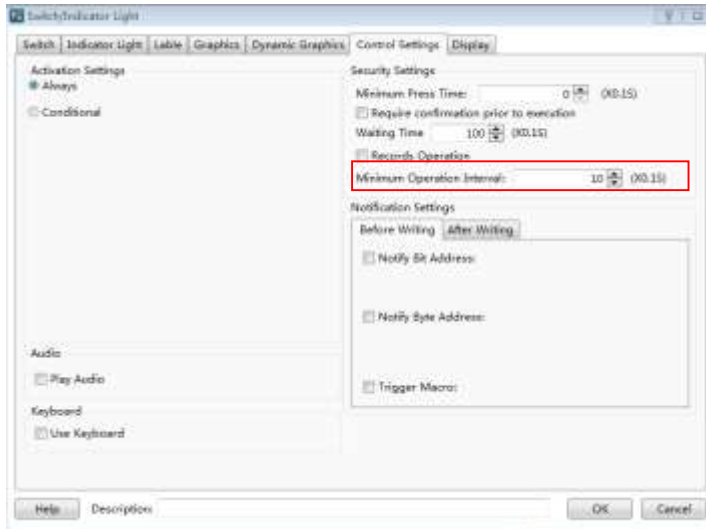

By using the “Minimum Operating Interval” function, continuous actions can be avoided in a short time due to touching the screen continuously by mistake.

4.13.6 Display

① Position

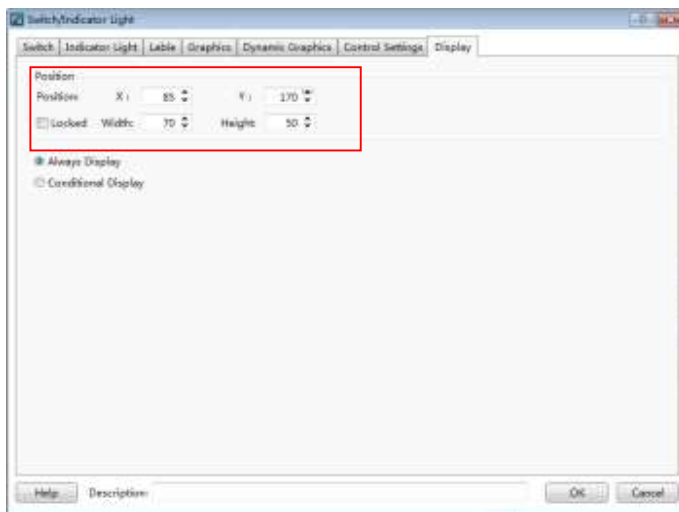

- Position and size

You can set X and Y coordinate values of the component to change the display position of it. You can modify the width and the height of the component to change the size of it.

- Locked

VEDA HCT User Manual

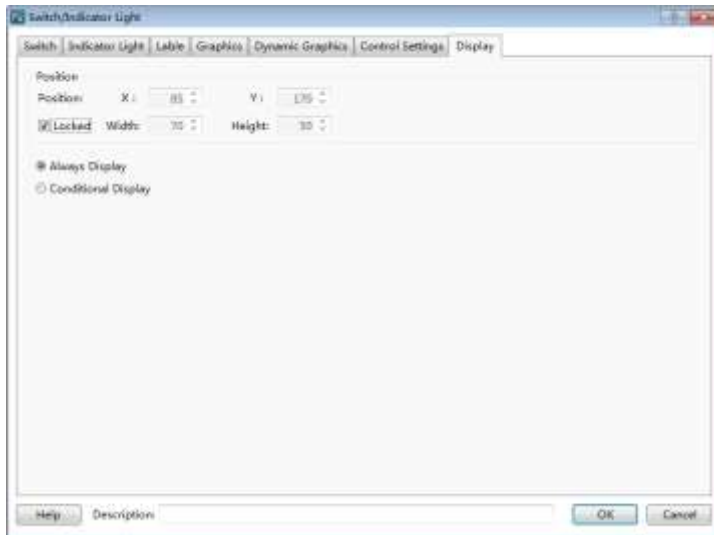

The position and size of the component cannot be changed if you check the “Locked” function. And there is a small lock icon on the component in the editing window. It is shown as below.

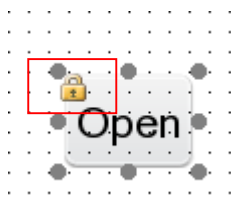

② Always Display



If you select the “Always Display” function, the component will always be visible when the project is running. It is the default setting.

③ Conditional Display

- Level User

VEDA HCT User Manual

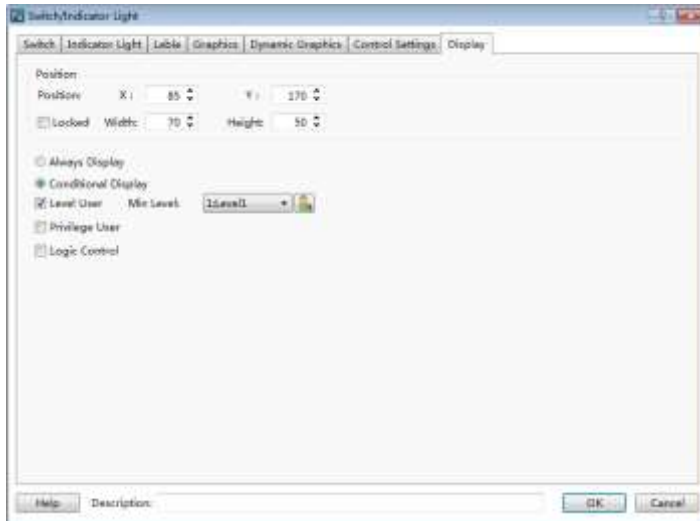

If you check this function, the component will be visible after you entering the appropriate user level password.

- Privilege User



If you check this function, the component will be visible after you login by using the corresponding user privilege.

- Logic Control

VEDA HCT User Manual

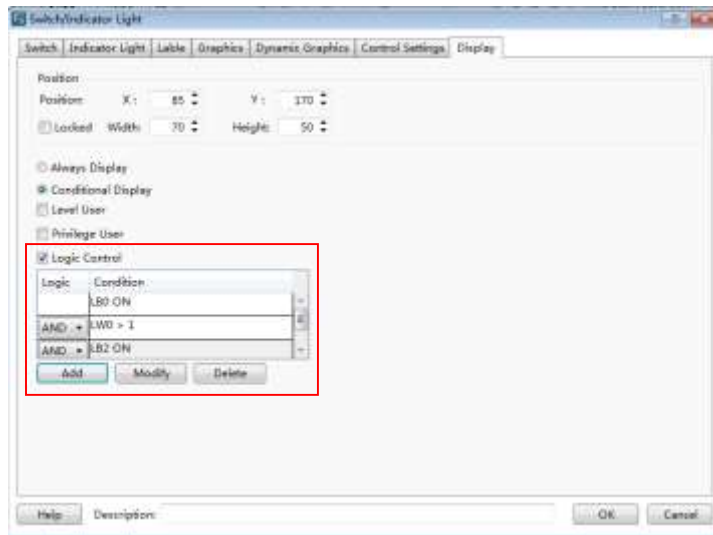

If you check this function, the component can be controlled to display according to the logic condition. The condition can be multiple logical operations.

4.13.7 Keyboard setting

For some components, there is a property TAB of "Keyboard Setting".



① Mode

- Touch Control

The keyboard will be popped up if you click the HMI input component.

- Bit control

A bit register is used to control the keyboard to pop up or close.

VEDA HCT User Manual

②Keyboard Settings

- Use pop-up keyboard

You can select the Keyboard Type from the system-provided keyboard types.

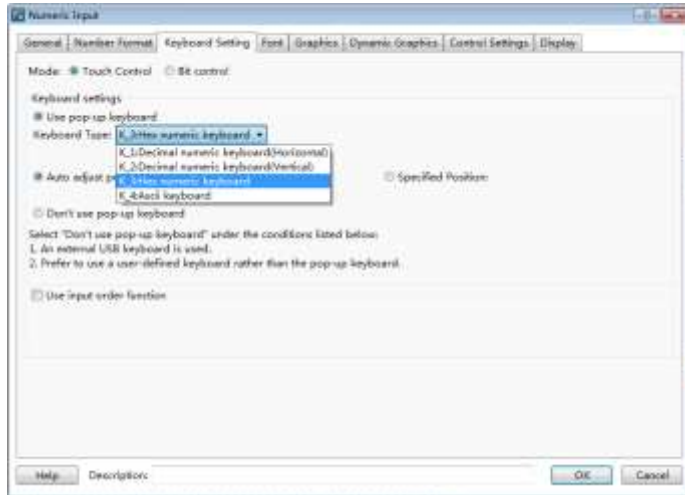

- Auto adjust position

The position of the pop-up keyboard is adjusted automatically according to the position of the HMI input component.

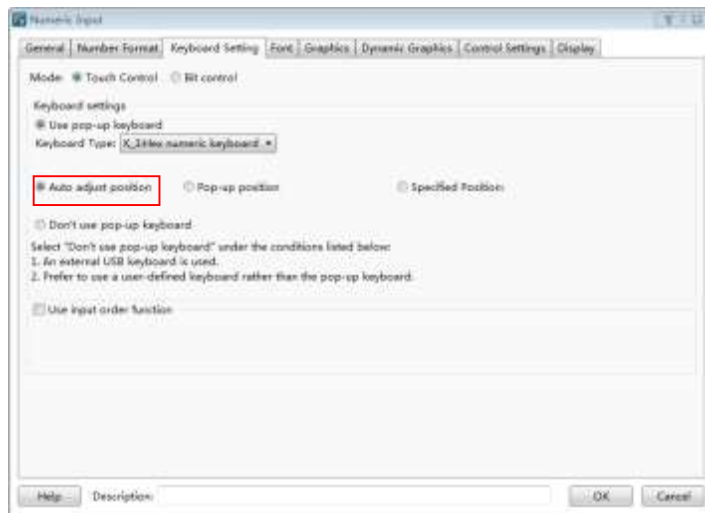

- Pop-up position

A relative region in HMI is specified to pop up the keyboard.

VEDA HCT User Manual

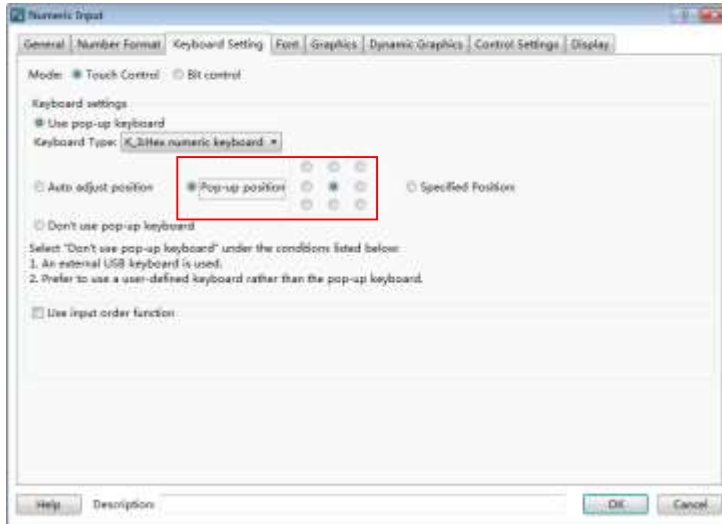

➤ Specified Position

The position to pop up the keyboard is specified by the X and Y coordinates.

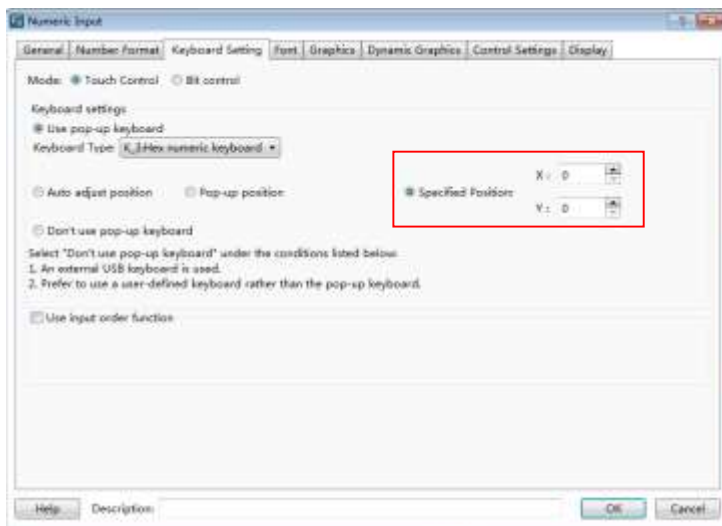

● Don't use pop-up keyboard:

If you need to use an external keyboard or a keypad which is designed by using the FS software, you should select the option "Don't use pop-up keyboard"

③ Use input order function

This function can be used to input the values into multiple input components continuously according to a specified order. You can check it when there are many input components.

VEDA HCT User Manual



- Input without order after input finished

The function of “Use input order function” will be canceled after you finish the input of multiple input components.

- Input Order

You can set the input order for the current input component here. The multiple components in one group can be input according to the order number, from small to large.

- Group

You can divide the input components into several groups and finish the input according to the input order in the current group.

4.13.8 Label

Adding a label for a component can be increased readability. You can set the properties of the label such as the language, the content, the font type and other settings. The display text will change when the status is switched if you set different text for different status.

VEDA HCT User Manual

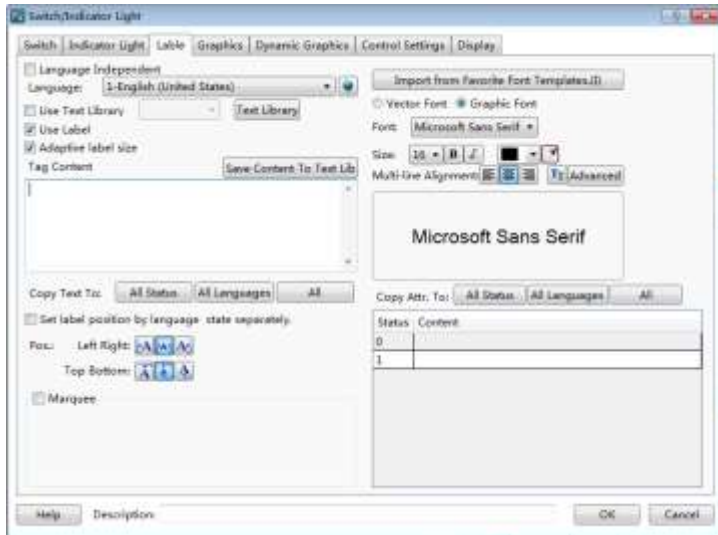

1 Language

Select a language for label edit. The settings will only take effect in the selected language.

2 Language Independent

When you change the language, the label content is not affected.

3 Use Text Library

After the “Use Text Library” is checked, the label content will be filled by the selected text entry in the text library. Some common text can be ready in the text library.

4 Use Label

You need to check this option when you want to set a label for the component.

5 Tag Content

You can edit a label for the current status here. So you edit the label in the tag content edit box, you should select the status first on the lower right corner. Then, click the next status to edit the next status label.



The text in the Tag Content edit box can be copied to all languages, all status or all languages and all status.

VEDA HCT User Manual

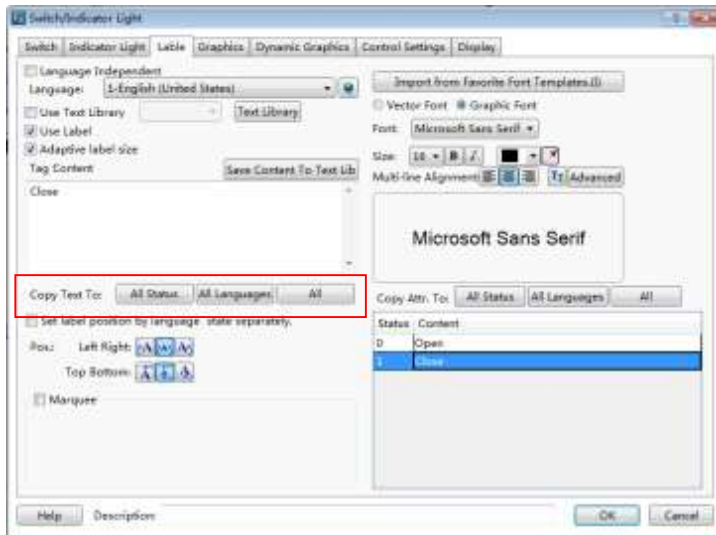

6 Label attributes

You can set the attributes for each Tag Content such as the font type, the size, the color, the alignment type, the Advanced Settings (Scaling, Space, and Shadow Effects) and other attributes. The function of “Copy text to” can avoid duplication of work. And you can also import from favorite font template to simplify label attributes editing. It is efficient and convenient.

7 Vector Font and Graphic Font

- Vector Font

According to the font attributes setting, change the characters of the text into a TrueType font file (ttf format) for HMI.

- Disadvantages
 - Only support the TrueType font type (ttf format) which the current operating system has installed.
 - The below is the font effect comparison between the two that the "Disable Vector Font Bordline Blurring Processing" is not checked and the "Disable Vector Font Bordline Blurring Processing" is checked.

Static Text

Static Text

Note: the "Disable Vector Font Bordline Blurring Processing" can be set in the path:

VEDA HCT User Manual

Project/Local HMI/System Settings/Extended Settings.

- Advantages
 - Occupy Less memory. The same character in the same font type uses one font data regardless of size, color, bold, or italic.
 - Full size and can be set freely without distortion.
 - Supports multi-line text alignment.
 - Text Library supports the use of vector fonts.

- Graphical Font

Regard the string as a whole and save it as a bitmap to the project.

- Disadvantages
 - Occupy more memory because of the bitmap storage format.
- Advantages
 - Supports all the fonts installed in the current operating system.
 - Display effect is good.

8 Marquee

In the VEDA HCT software, every label of the component can be set to display by scrolling the fonts. The scrolling direction, step length, speed, etc. can be set separately.

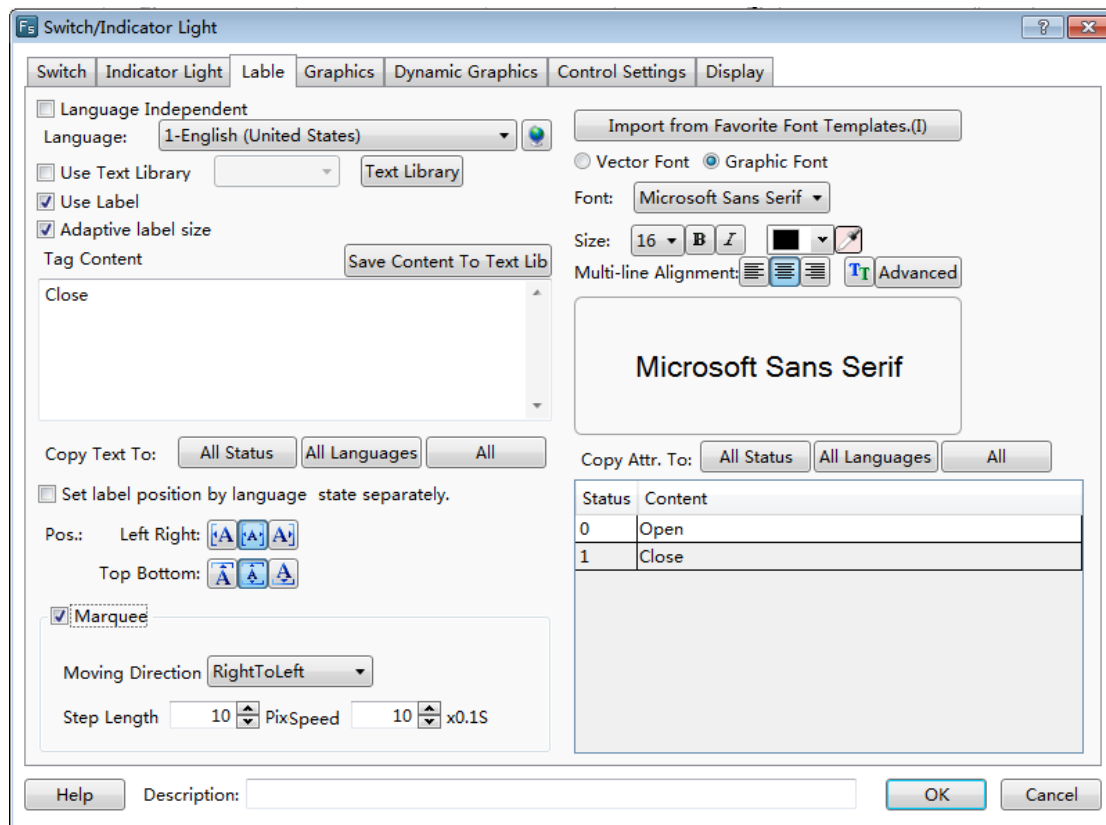

4.13.9 Marquee

The function of "Marquee" is to display text by scrolling the fonts. The components such as "Label" and "Static Text" have the "Marquee" function.

VEDA HCT User Manual

When you check the "Marquee" option for the label or the static text ,the fonts will display by scrolling. You can set the attributes such as the Moving Direction, Step Length and Pix Speed. The setting is shown as below.

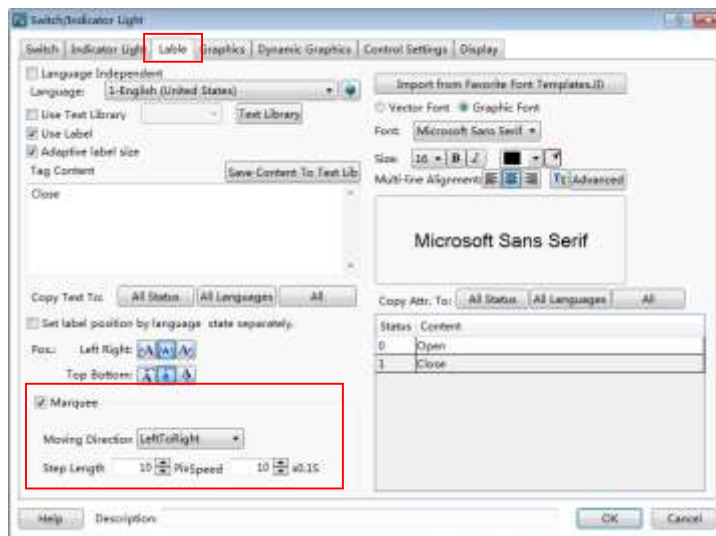
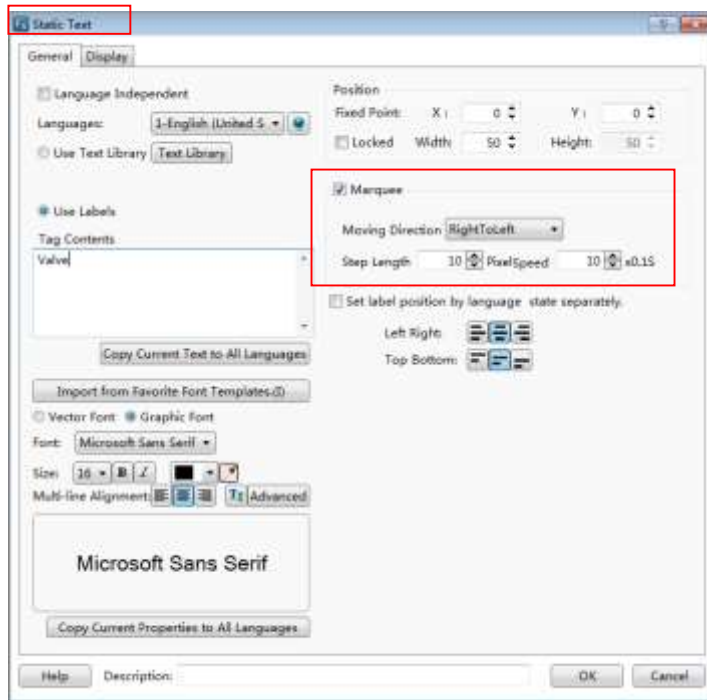

1 Moving Direction

There are four moving direction: Left To Right, Right To Left, Top To Bottom and Bottom To Top. Select one to be the moving direction of fonts scrolling.

2 Step Length

The fonts scroll step by step. The distance of two steps is Step Length. The unit of Step Length is pixel. For example, setting Step Length 10 means that the fonts move 10 pixels per second.

VEDA HCT User Manual

3 Pix Speed

The option “Pix Speed” is used to set the moving speed of fonts scrolling. The unit of Pix Speed is 0.1 seconds. The range of Pix Speed is from 1 to 255. For example, setting PixSpeed10 means that the moving speed of fonts scrolling is 1 second. The process will be circulated after all fonts move out in the component size range.

4.13.10 Logic Control

You can find the function of “Logic Control” if you select the option “Conditional” in the “Control Settings” property TAB of some component. Or you can find it if you select the option “Conditional Display” in the “Display” property TAB. You can also find it if you select the option “Condition” in the “Trigger and Stop” property TAB of the Timer component. This function can realize all kinds of logic operations or judgment easily and can reduce using macros.

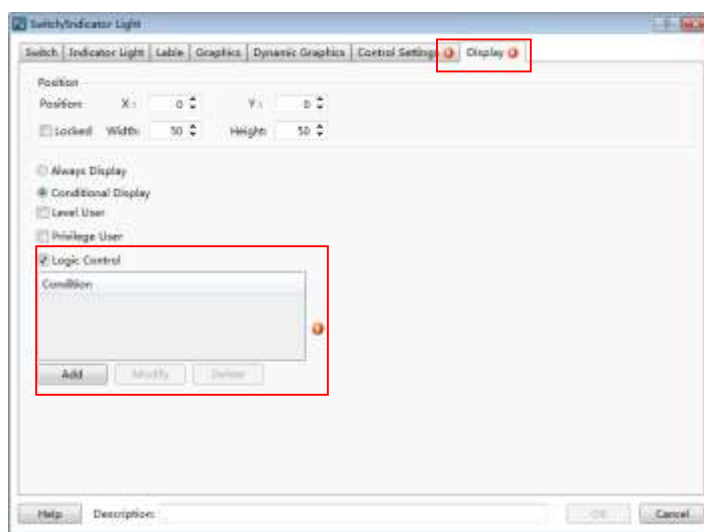
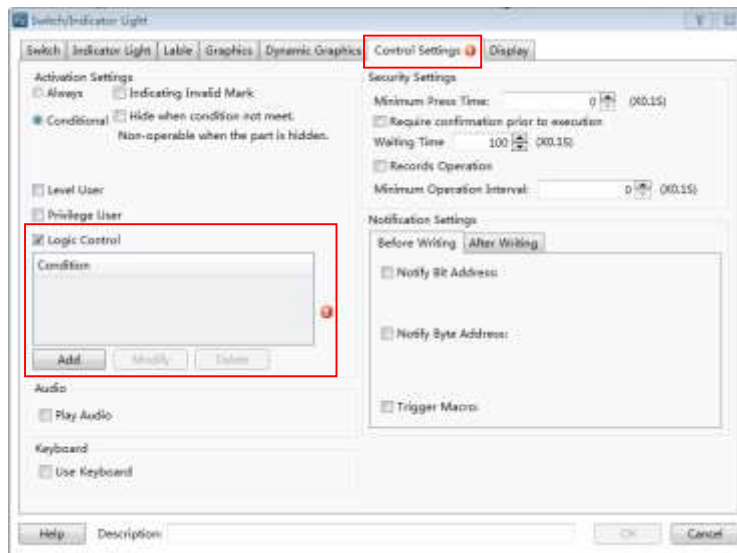

VEDA HCT User Manual

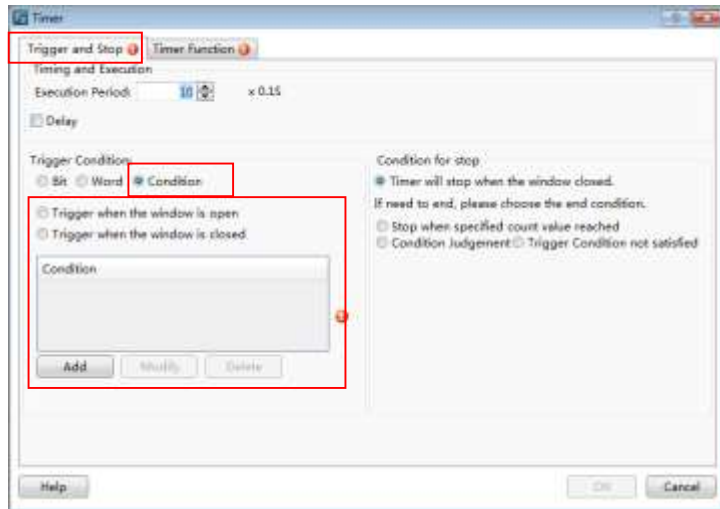

There is a red exclamation mark due to no logic condition. Now click the button "Add", you can pop up the Condition Setting dialog.



There are two address types: Bit Register and Word Register. The default selection is Bit Register. The logic condition judgment for Bit Register is "ON" or "OFF". The default selection is "ON". Click the tool button "  " or double-click the "Address" blank box, you can edit and select a "bit register". For example, set the address of "Bit Register" LB0, and set the Condition "ON". It is shown as below.



VEDA HCT User Manual

The red exclamation mark will disappear after you select an address for the condition. Click the button “OK” and the condition will be added to the Logic Control list. It is shown as below. It means the current component will be valid when the bit register LB0 is ON.

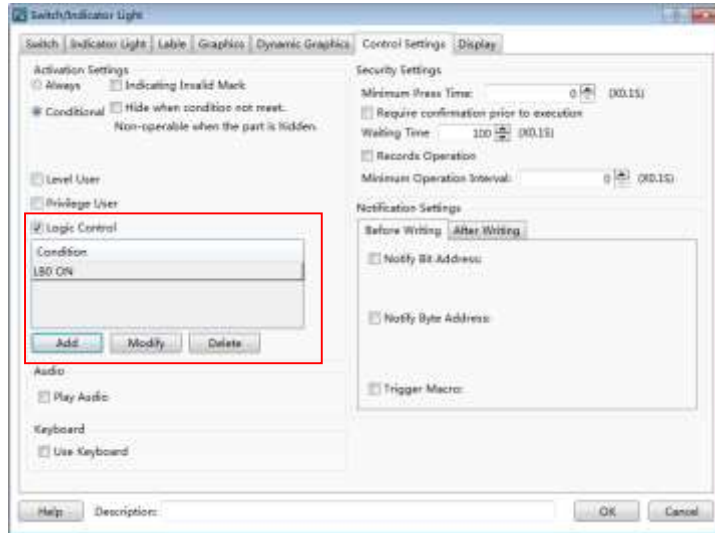

If the condition is not enough, you can continue to add. For example, the condition “LW0 > 1” need to be added. You can click the button “Add” to go on the operation. The Word Register is selected and the address is set LW0. The condition is set “LW0 > 1”. The setting is shown as below.



There are two pop-down lists in the Condition setting area. The first list is used to select the compare relationship. The compare relationship symbols include "<", ">", "<=" ">=", "==" and "!=". The second list is used to add the next condition of the word register LW0. The default of the second list is “None”. It means that there is not the next condition any more. You can select "AND" or "OR" in the second list. It means the relationship between the current condition and the next condition.

VEDA HCT User Manual

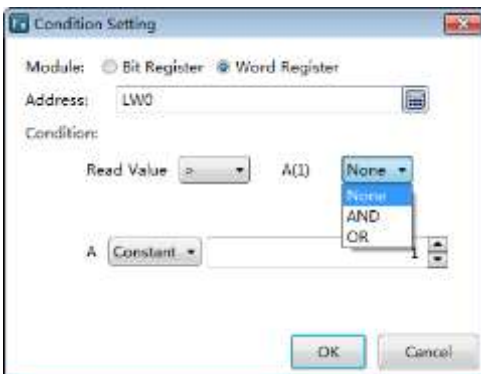
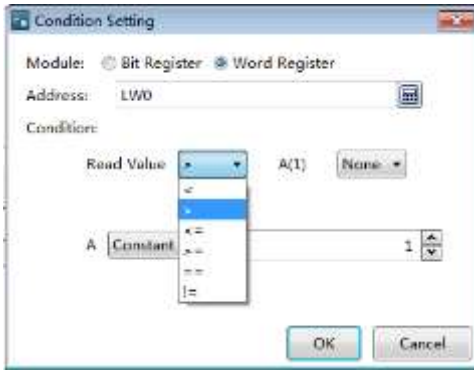

The setting is shown as below if you select "AND" in the second list.

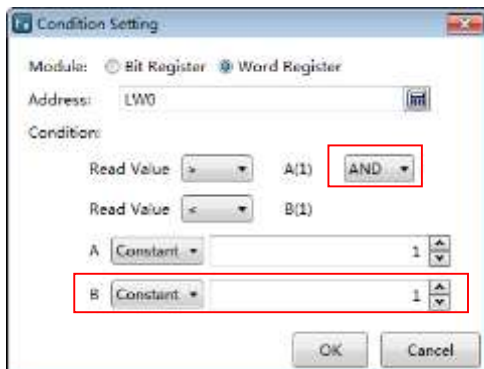

If the conditions you need is "LW0 > 100" and "LW0 < LW1", then the condition of the second is not "constant" but "variable" and the address is LW1. The setting is shown as below.

VEDA HCT User Manual



After click the button "OK", you can add this condition to the Logic Control list. It is shown as below.

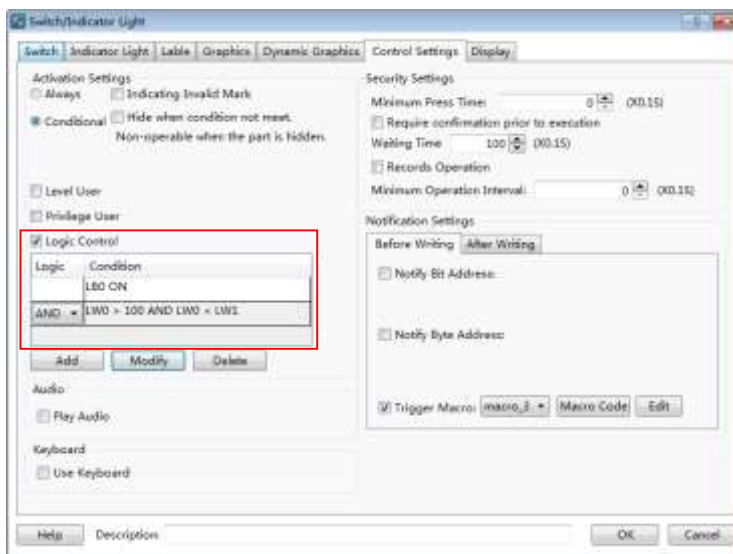

There is a relationship option in front of the second condition in the Logic Control list. The option can be set "AND" or "OR". It means the logic relationship between the previous User condition and the following condition. The component can be operated or display only if the result of all the conditions logic operation is true.

VEDA HCT User Manual

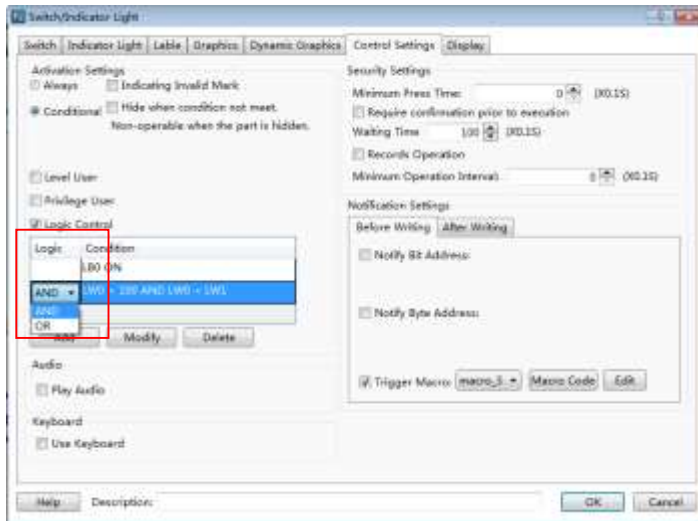

There are the button "Modify" and the button "Delete" besides the button "Add" in the Logic Control list. After selecting a condition in the Logic Control list, you can click the button "Modify" to edit it again or click the button "Delete" to remove it from the Logic Control list. You can also double-click a condition in the Logic Control list to modify it.

Note: the conditions are executed sequentially from the top to the bottom in the Logic Control list when the conditions are more.

4.13.11 Shadow Effect

You can set the property "Shadow Effect" for the vector graphics, the bitmaps, the graphics, the fonts, and so on. It is shown as below.

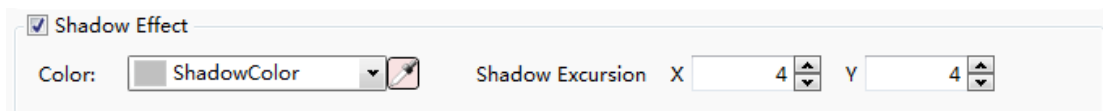

After checking the "Shadow Effect", the setting options such as Color and Shadow Excursion will be displayed. Otherwise the options are not visible.

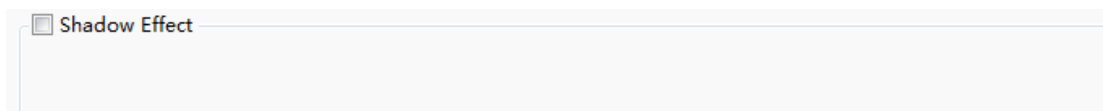

1 Color

You can use the color palette to set the shadow color.



VEDA HCT User Manual

You can also use the tool  to set the shadow color.

2 Shadow Excursion

The Shadow Excursion includes the X-axis (horizontal) direction offset and the Y axis (vertical) direction offset. The unit is pixel.

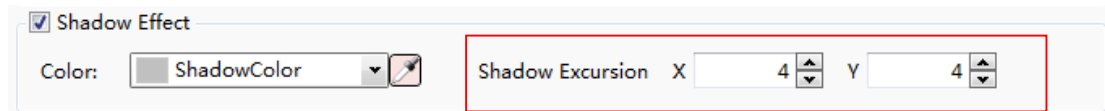

Note:

- The coordinates in this software refer to: [Detailed manual/General functions/Drawing/ Position](#).
- The range of Shadow Excursion is: -16 to 16. The positive number for X-axis represents the shadow direction is to the right. The positive number for Y-axis represents the shadow direction is downward. The negative number represents the contrary direction.

The display results are shown as below.

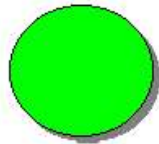

Shadow Effect

4.13.12 Position

Every component has the property of “Position”. You can find it in the “General” property TAB or the “Display” property TAB of the component.

VEDA HCT User Manual

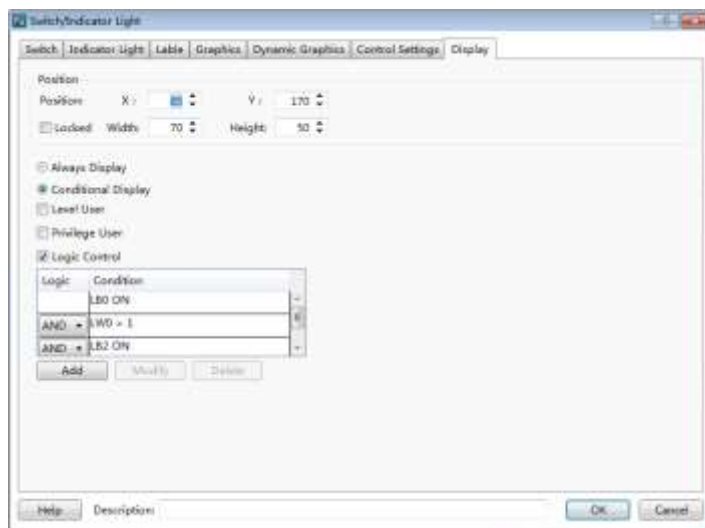
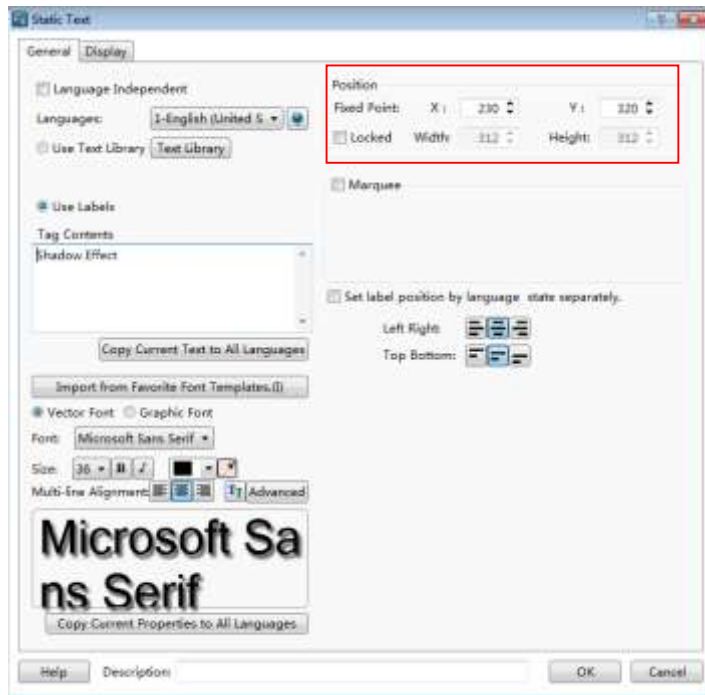

The “X” and “Y” in the Position property are used to set the x coordinate and the y coordinate of the start point of the current component in the window. The title of the “X” and “Y” is “Fixed Point” or “Position”. The title of "Fixed Point" decides a fixed point as the start point of the component. The detail is referred to: [Detailed manual/ General functions/ Drawing/ Rotation](#). The title of "Position" decides the point in the upper left corner of the component as the start point.

Note:

In this software, the coordinate system is shown as below. The origin point is in the upper left corner. The X-axis is horizontal direction. The positive direction of the X-axis is to the right. The Y-axis is vertical direction. The positive direction of the Y axis is downward.

VEDA HCT User Manual



The properties of “Width” and “Height” are used to set the width and the height of the component. If the option is grey and not editable, it represents the attribute is not available. It is shown as below.



If you check the option “Locked”, the position of the component will be locked. Its position and size cannot be edited. A lock mark will display in the upper left corner of the component when you select it in the configuration window.

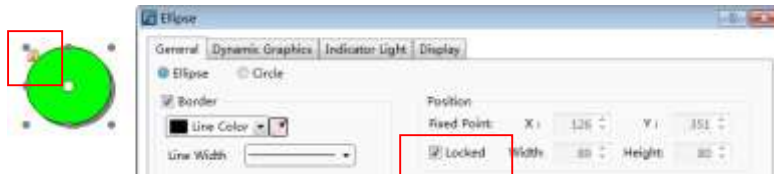

4.13.13 Rotation

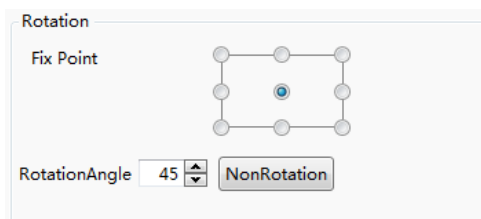

The function of “Rotation” can adjust the display angle of the components such as static graphics, vector graphics and other components. This function is a static function. That is, the display angel is not adjusted in the HMI if you set the display angle in the “Rotation” property. If you want to dynamically adjust the display angle of the graphics, please refer to: [Detailed manual/General functions/Dynamic Graphics](#).

1 Fix Point

Each figure has nine fixed points. The middle fixed point is selected as the default by the system. You can change the fixed point. The result is different after the figure rotates

VEDA HCT User Manual

around the different fixed point. For example, a rectangle rotates the center fixed point and another rectangle rotates the upper left fixed point. It is shown as below.

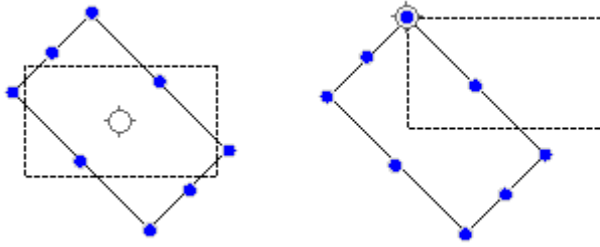

2 Rotation Angle

The Rotation Angle is used to set the clockwise rotation angle of the component. This angle range is 0-360 degrees.

3 Non Rotation

You can quickly set the display angle to zero by clicking the button “Non Rotation”.

4.13.14 Dynamic Graphics

There is a property TAB of “Dynamic Graphics” for some component such as the static picture component, the vector graphics, and so on.

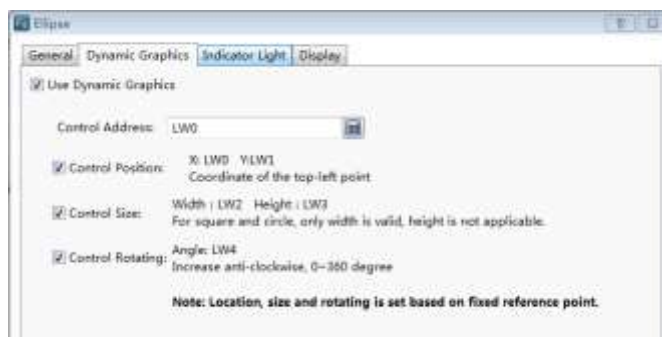

You can use the function of “Dynamic Graphics” if you want to adjust the position, the size and the rotation angle of the figure dynamically during running the HMI.

The function of dynamic graphics is realized by using the registers to control the position, the size, and the rotation angle of the figure dynamically.

① Use Dynamic Graphics

You need to check the option “Use Dynamic Graphics” in the property TAB of “Dynamic Graphics” if you want to use the dynamic graphics function.

② Control Address

VEDA HCT User Manual

The start address of the control registers is selected here. The start control register address editing is referred to: [Detailed manual/General function/Address editor/Standard ByteAddress Input](#).

③Control Position

The option of "Control Position" needs to be checked if you want to adjust the position of the component dynamically. Two registers are used. The addresses will be set and displayed automatically after the "Control Address" is given. These two registers will control the absolute coordinates of the fixed point of the component on the screen window. The touch screen coordinate system is referred to: [Detailed manual/General function/Drawing/Position](#).

④Control Size

The option of "Control Size" needs to be checked if you want to adjust the size of the component dynamically. Two registers are used. The addresses will be set and displayed automatically after the "Control Address" is given. These two registers will control the width and the height of the component. The register to control the width is valid for the components which the width and the height are equal, such as the square and the circle.

⑤Control Rotating

The option of "Control Rotating" needs to be checked if you want to adjust the rotation angle of the component dynamically. One registers is used. The address will be set and displayed automatically after the "Control Address" is given. The register will control the clockwise rotation angle of the component. This angle range is 0-360degrees.

Note:

The position, size, and rotating control are based on the "fixed point" of the component. The fixed point is referred to: [Detailed manual/General function/Drawing/Rotation](#).

4.13.15 Table Drawing

You can find the property TAB "Table".

VEDA HCT User Manual

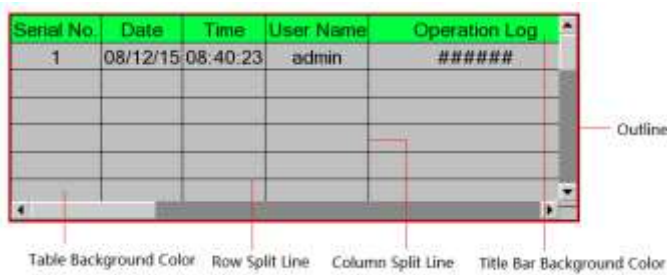
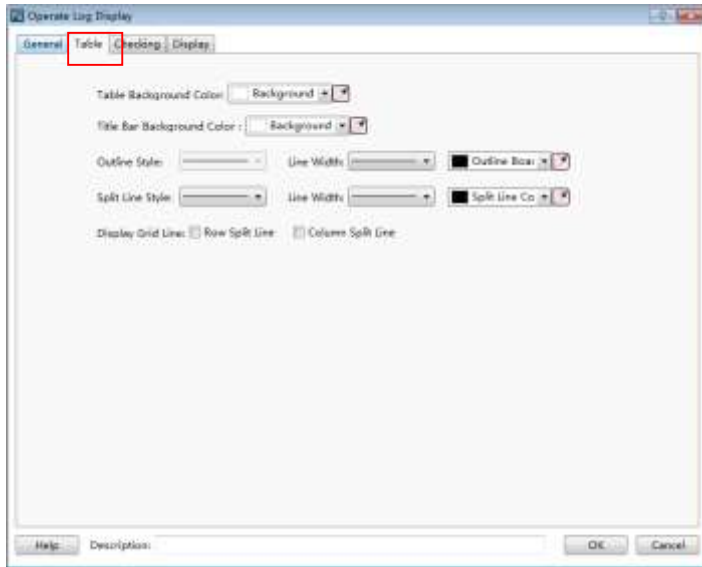

You can change the background color and the title bar background color.

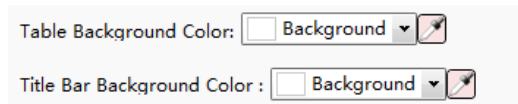

You can change the outline style, the split line style, the line width and the line color.

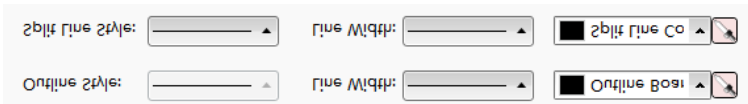

You can display the grid line after check the “Row Split Line” and the “Column Split Line”. It is shown as below.

VEDA HCT User Manual

Serial No.	Date	Time	User Name
1	08/12/15	08:40:23	admin

You can hide the grid line if you don't check the "Row Split Line" and the "Column Split Line". It is shown as below.

Serial No.	Date	Time	User Name
1	08/12/15	08:40:23	admin

4.13.16 Export CSV

You can use the function of "Export CSV" if you want to export the list data to a CSV format file. You can find the option "Export CSV" in the "Search" or "Checking" property TAB of the list component, such as the Historical Data Display component and the Operator Log component.

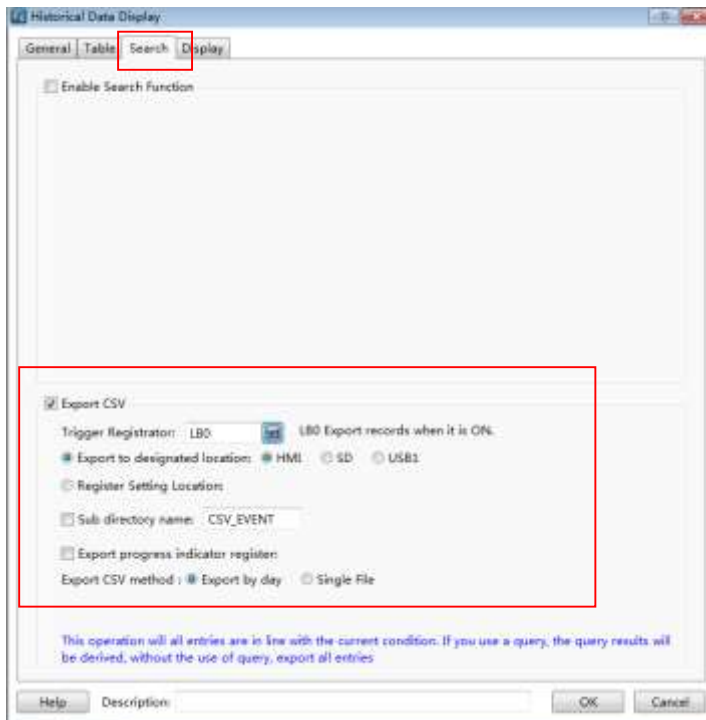

VEDA HCT User Manual

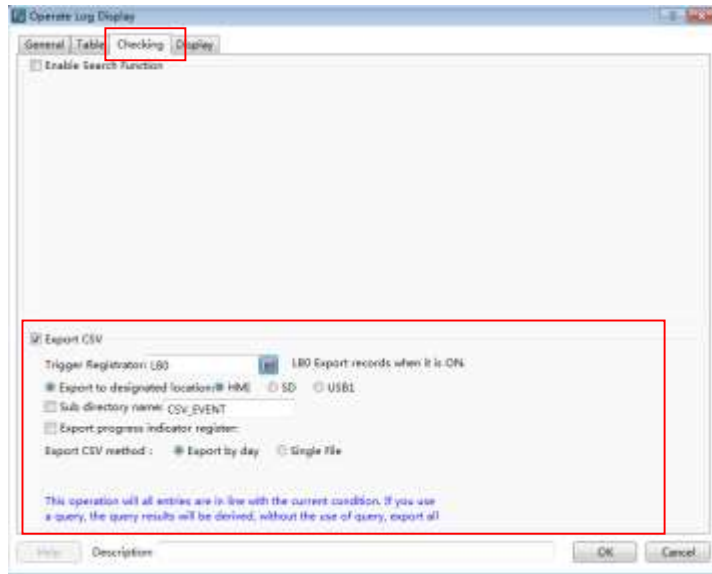

① Trigger Registrar

A bit register is used to trigger the action of exporting data to a CSV file. Exporting is triggered when the bit register changed from OFF to ON. You can use a bit toggle switch to control the bit register. The method to input the trigger register address is referred to: [Detailed manual/General function/Address editor/Standard Bit Address Input](#).

② Export to designated location

The function of “Export to designated location” supports exporting the CSV file to HMI, SD card or USB disk. The corresponding options are: HMI, SD, USB1.

③ Subdirectory name

You can give a sub directory name for the exporting location.

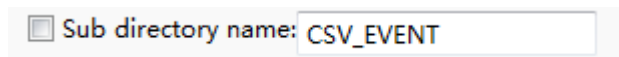

The contents saved in the designated registers will provide the sub directory name if you check the option “Sub directory name” and give the start register address.

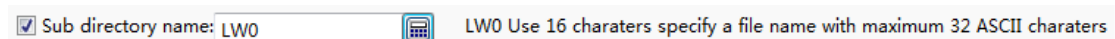

Note:

Please use the character component to input the sub directory name if you use registers to provide it. The method to input the register is referred to: [Detailed manual/General function/Address editor/Standard ByteAddress Input](#).

④ Export progress indicator register

VEDA HCT User Manual

A register can be given to display the exporting progress if the data is large. It is shown as below.



The exporting progress uses the percentage of completion (0-100) to represent. You can use a numeric value display component or a bar graph component to display.

⑤ Export CSV method

The Export CSV method can be “Export by day” or “Single File”. If you select the “Export by day”, the exported data will be saved in different files by date. If you select the “Single File”, the exported data will be saved in a single file.

If you select “Single File”, you can use the function of “User-defined File Name”. The system will name the exported file according to the default name rules when the option “User-defined File Name” is not checked. A register address needs to be specified to save the file name which is input when it is needed.

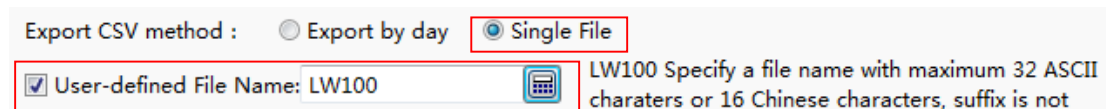

Please use the character input component to input the user-defined file name. The file name length is limited to 32 ASCII characters or 16 Chinese characters.

Note:

This operation will export all entries in the current condition. If you use the function of “Enable Search Function”, the current result of searching will be exported.

5 Use topic

5.1 Find and Replace



VEDA HCT User Manual

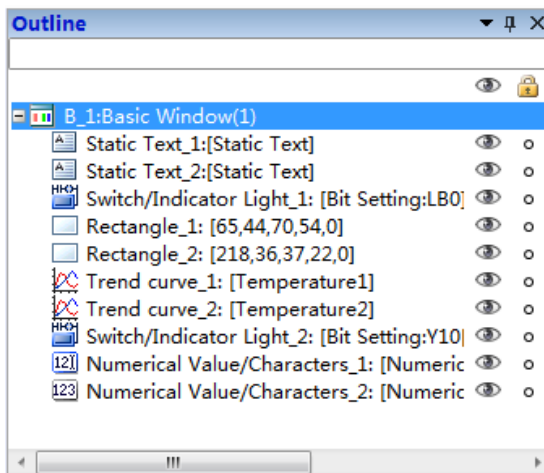

5.2 Outline

It will display all components of the current work window in the “Outline” window.



The tool button “” on the top right corner which is used to control the display mode of the outline window. The tool button “” is used to make the outline window show or auto hide. The tool button “” is used to close the outline window.

VEDA HCT User Manual

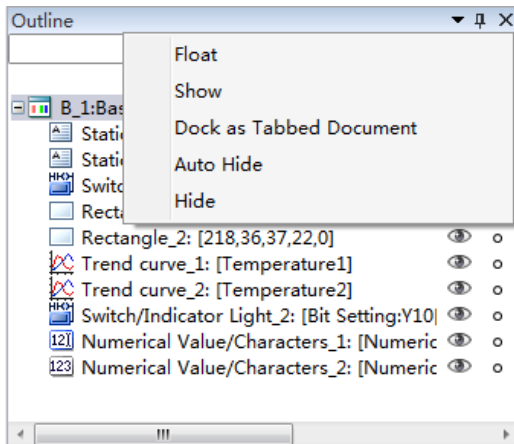



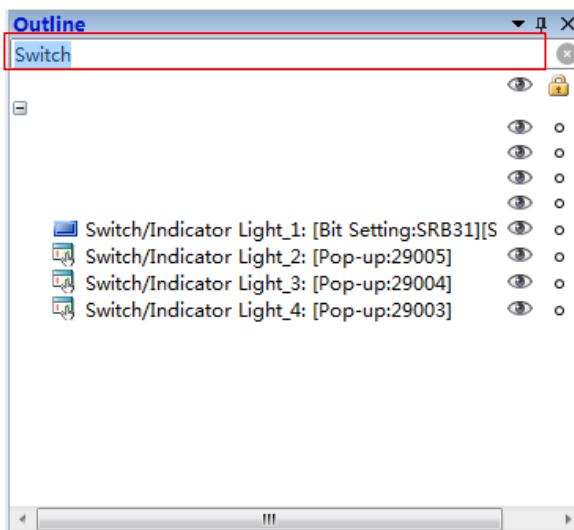

Note:

You can check “Outline” from the “View” menu and make the outline window display again after the Outline window is closed.





You can find the component by inputting the component name in the blank text box on the top of the outline window and click the “Enter” key. All the components display can be restored by clear the text box and click the “Enter” key.

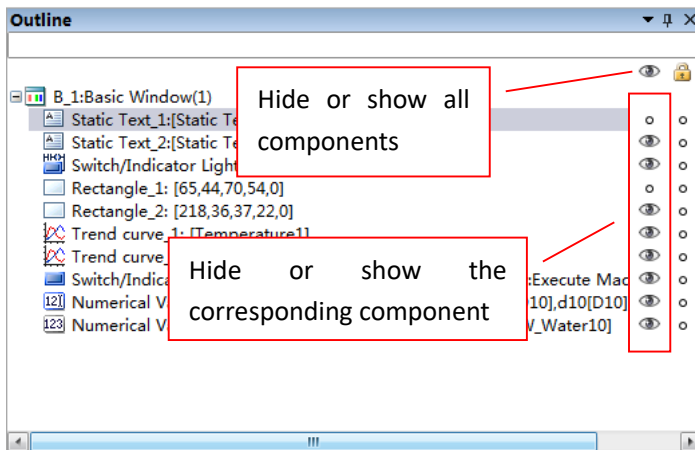

When you click the little eye tool “” except the top one, it will change to “” and hide the corresponding component in the window. When you click it again, it will change to “” and make the corresponding component show in the window. The top little eye tool “” will control all components hide or shown by clicking it.

VEDA HCT User Manual



When you click the right tool “”, it will change to “” and lock the corresponding component in the window. When you click it again, it will change to “” and unlock the corresponding component. The top tool “” will control all components locked or unlocked by clicking it. The component will not move if it is locked.

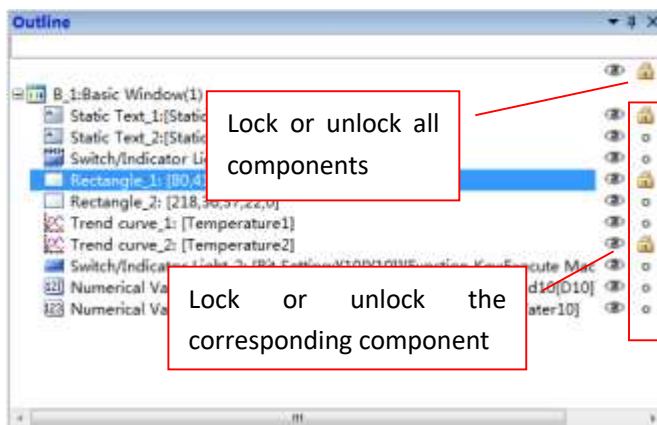

You can right-click to pop up the shortcut menu and cut, copy, paste or delete the selected components. You can look at the components properties by this way.

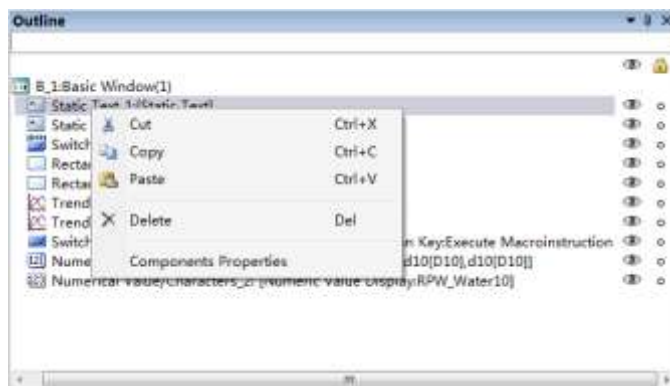

VEDA HCT User Manual

5.4 Macro

5.4.1 Macro Editor Introduction

The Macro Editor can be opened by clicking “Create Macro” or “Edit Macro” from the “Macro” menu. It is shown as below.

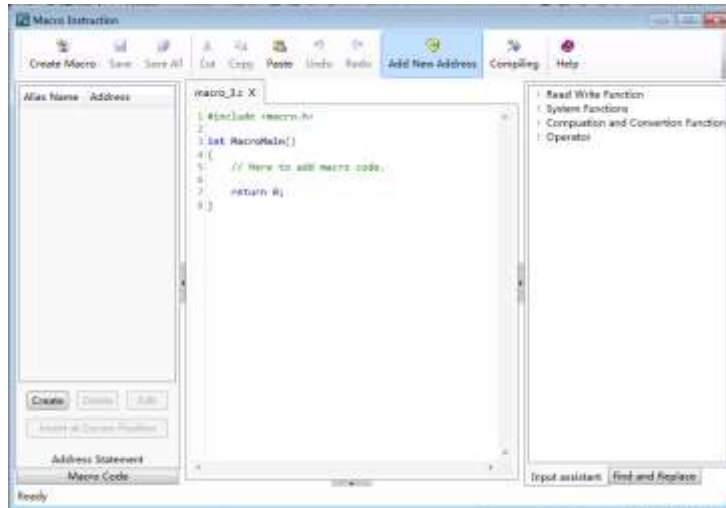

5.4.1.1 Shortcut Tools Bar



Shortcut Tools Bar contains Create Macro, Save, Save All, Cut, Copy, Paste, Undo, Redo, Add New Address, Compiling and Help buttons.

Create Macro: Create a new macro.

Save: Save the current macro.

Save All: Save all macros.

Cut, Copy, and Paste: Edit the selected macro codes.

Undo, Redo: Undo /Redo the edit of the selected macro codes.

Add New Address: Add a new address alias for the current macro.

Compiling: Compile the current macro.

VEDA HCT User Manual

Help: Open the help file.

5.4.1.2 Address Statement

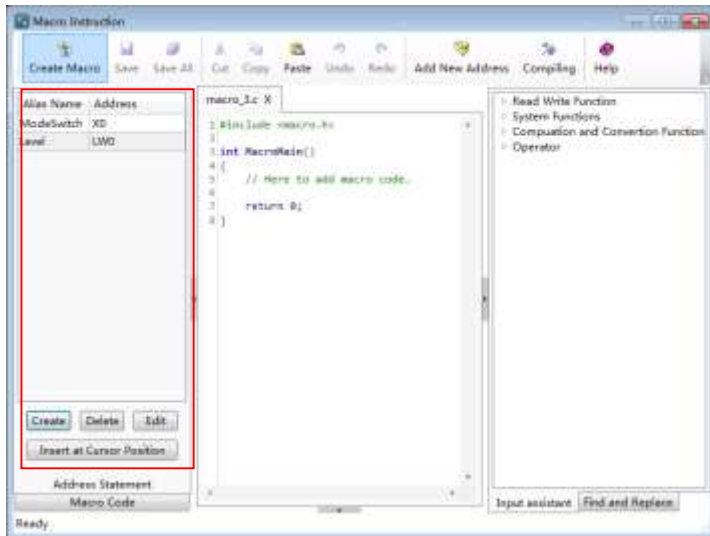

Address Statement is used to create and manage the address aliases in the current macro. The address statement window shows on the left of the macro editor. You can

hide or display it by using “”. You can switch to the macro code window by clicking the bottom tab “Macro Code”.

5.4.1.3 Macro Code

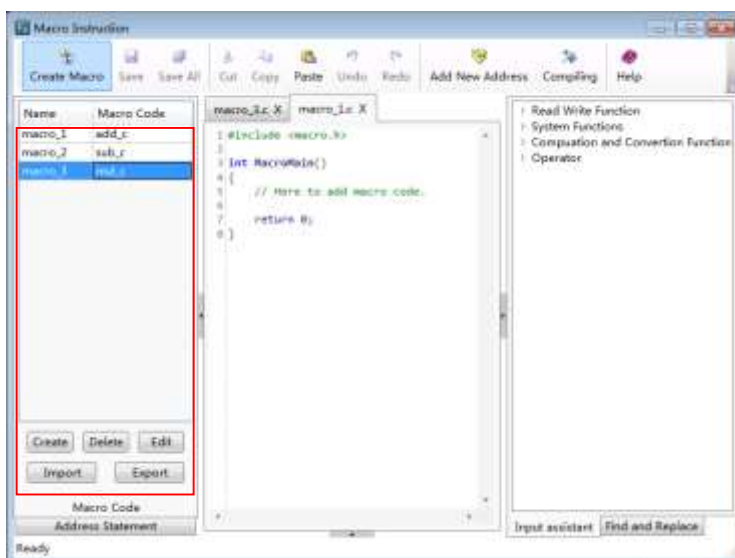

VEDA HCT User Manual

Macro Code window is used to create or manage the macros in the current project. All macros in this project will be listed here. These macros can be edited, deleted, imported and exported. You can simply double-click a macro's name to edit the codes of the macro.

5.4.1.4 Code Editor Window

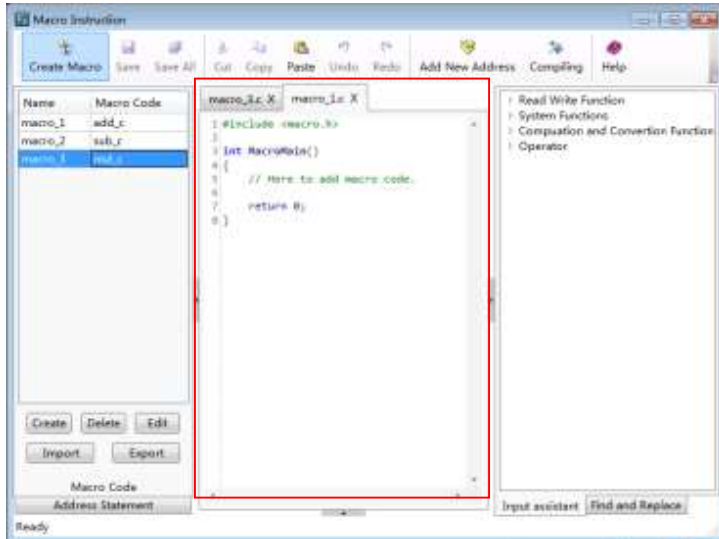

Code Editor Window is a code editor which is compatible with C syntax. The detailed macro codes are edited here. Code Editor Window is a multi-tab window. You can open multiple macros and display one macro by clicking the corresponding tab. If a macro code has been edited but not yet saved, it will display “*” in this macro tab. For example, it will display “macro_1.c*” if the codes of this macro are edited and not saved.

5.4.1.5 Input assistant Window

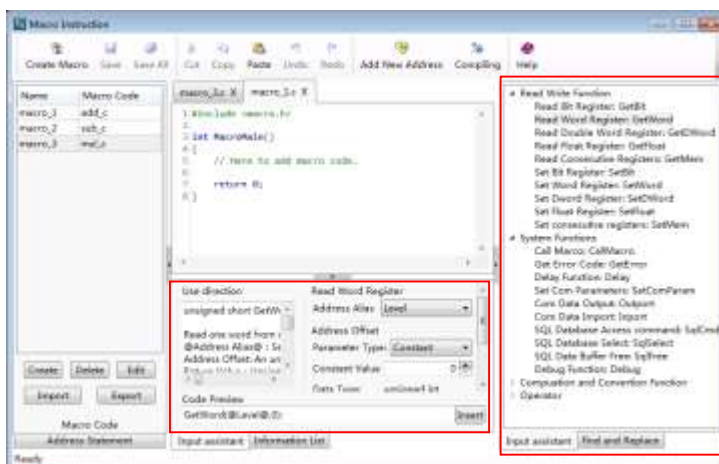

Input assistant Window on the right of the macro editor lists the built-in functions. It will display a detailed description of the function in the Input assistant Window at the lower middle position of the macro editor when you select a built-in function on the right window.

VEDA HCT User Manual

The Input assistant Window at the lower middle position of the macro editor gives the use direction. And you can set the parameters of this function here, too. The function with the parameters you have set will display in the Code Preview edit box. It will be inserted into the current cursor position when you click the “Insert” button.

5.4.1.6 Find and Replace

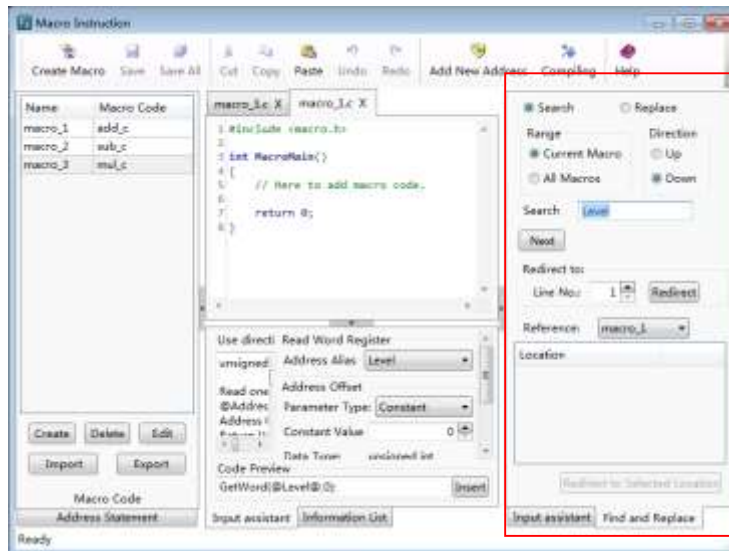

Find and Replace function can provide a more convenient method of editing the macro codes. It can perform jump between lines and you can view the macro reference here.

5.4.1.7 Information List

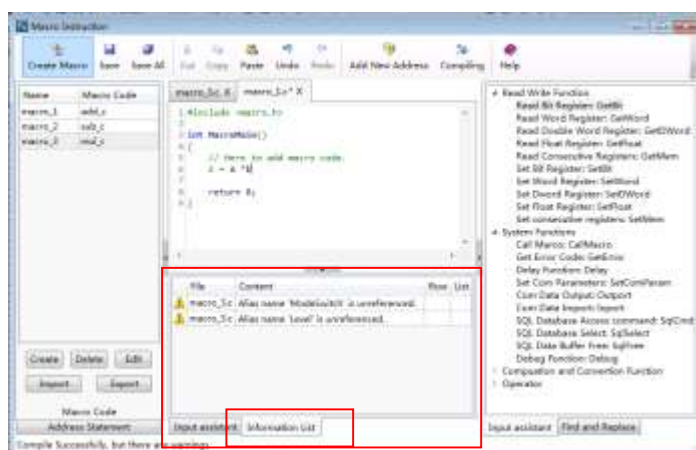

Information List window displays prompts and error messages when the macro compile. You can double-click the error message entry in the list if compiling errors occur. It will quickly navigate to the position where this error occurs.

VEDA HCT User Manual

5.4.2 A Macro example

In this example, we use a macro to execute a simple calculation function. The output value (saved in LW1) will be 3 times as much as the input value (saved in LW0) if the output value is less than or equal to 300, or it will be 2 times as much as the input value.

5.4.2.1 Create a new project

Refer to: [Detailed manual/File/Create New Project.](#)

Build a new project.

5.4.2.2 Add the components

① Add a numeric value input component.

Refer to: [Detailed manual/Component/Numeric Value and Character Display/Numeric Value Input.](#)

Add a numeric value input component in the window and set the address as LW0.

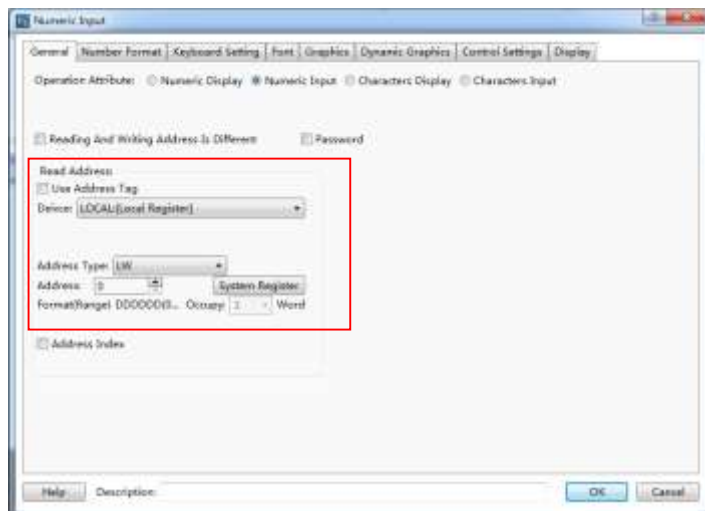
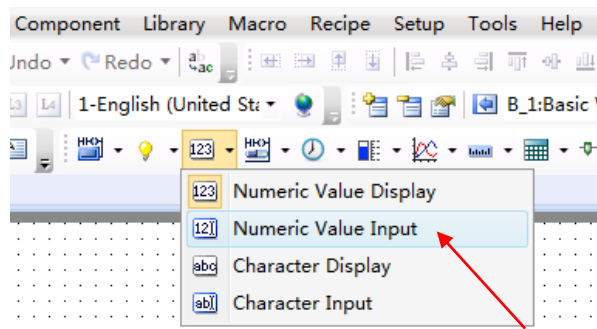

② Add a value display component.

VEDA HCT User Manual

Refer to: [Detailed manual/Component/Numeric Value and Character Display/Numeric Value Display](#).

Add a numeric value display component in the window, and set the address as LW1.

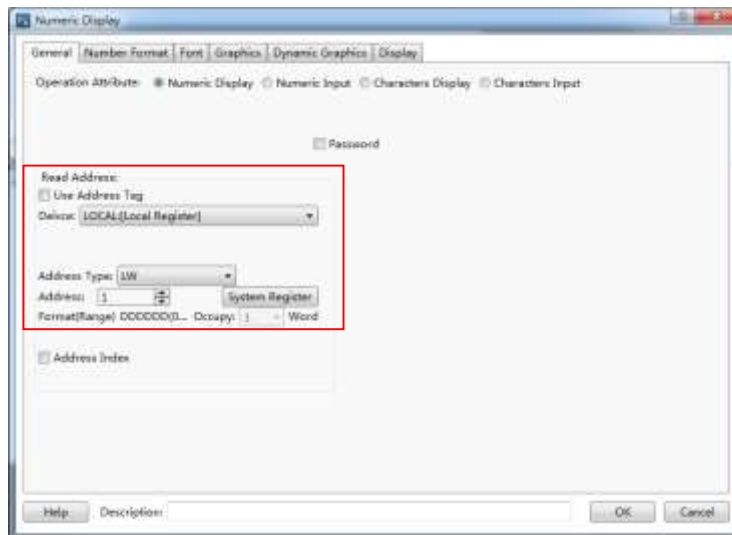
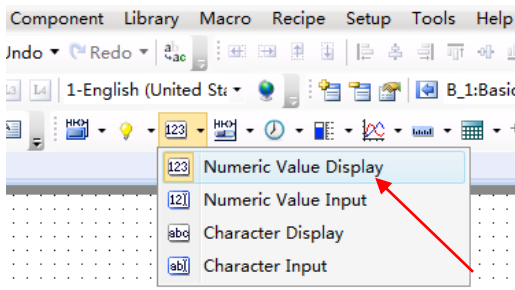

③ Add the text description.

Refer to: [Detailed manual/Drawing/Static Text](#).

Add text description for the two numeric value components, as shown as below.



5.4.2.3 Create and edit a macro

① Create a new macro.

Refer to: [Detailed manual/Macro/CreateMacro](#).

VEDA HCT User Manual

Create a new macro, named "Computing".

② Add an address statement.

Add an address statement. Define the LW starting address LW0 as LW_Start_Addr.

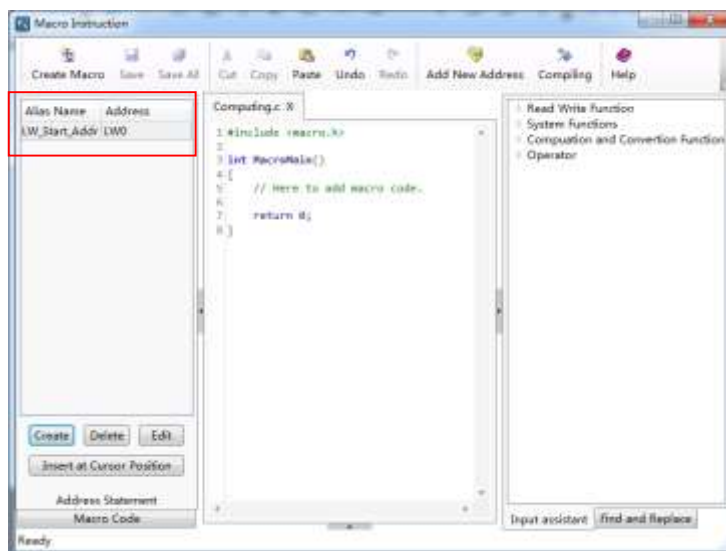
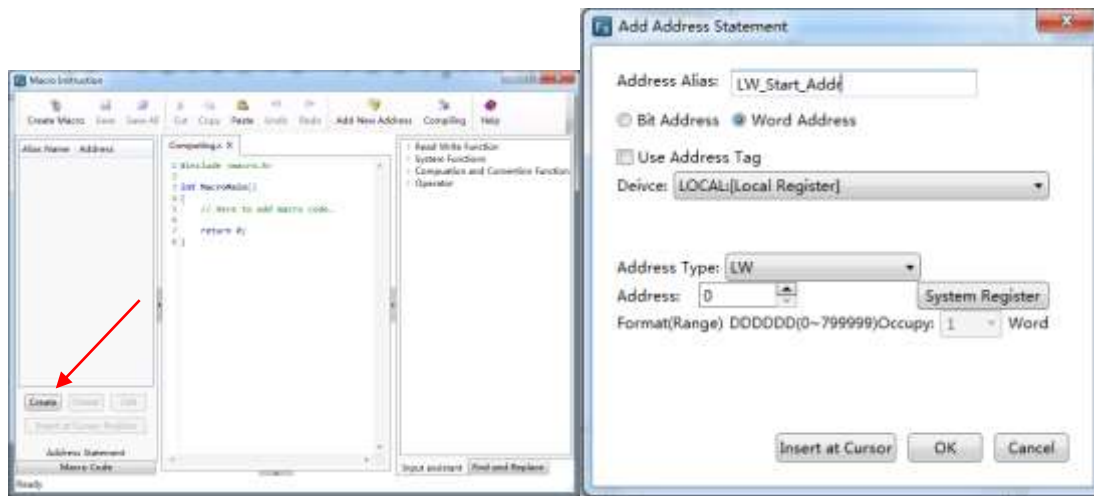

③ Edit the macro codes.

In the macro code editor window, edit the macro codes according to the logic previously defined. The syntax rules follow the C language specification. The final macro codes are as follows.

VEDA HCT User Manual

```
Computing.c* X
1 #include <macro.h>
2
3 int MacroMain()
4 {
5     // Here to add macro code.
6     unsigned short x = 0, y = 0; //define the variables.
7     x = GetWord(@LW_Start_Addr@,0);GetWord(@LW_Start_Addr@,0);//read LW0 to x
8     if(x <= 300) //if x <= 300
9     {
10        y = x * 3; //y = 3x
11    }
12    else //or
13    {
14        y = x * 2; //y = 2x
15    }
16    SetWord(@LW_Start_Addr@,1,y); //write the value of y to LW1
17    return 0;
18 }
```

④ Compile and save.

Click the Compile button “” on the shortcut toolbar to compile after finish editing the macro codes. A message box will pop up to display “Compile Successfully” if no syntax errors; otherwise the message box will display “Compile Failure”.

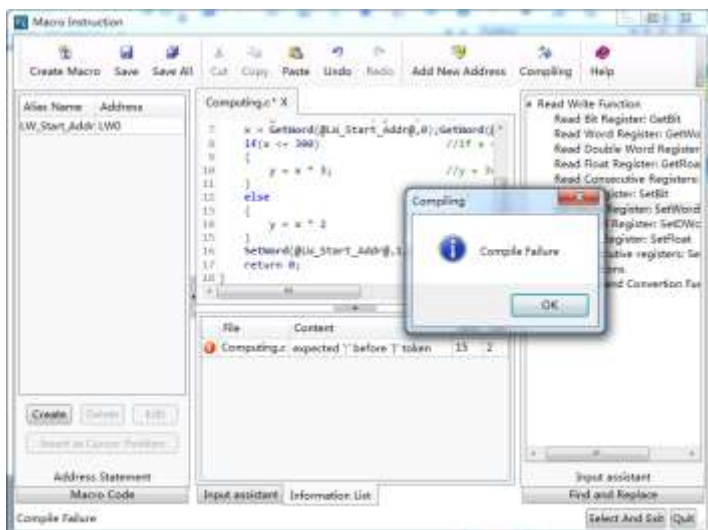
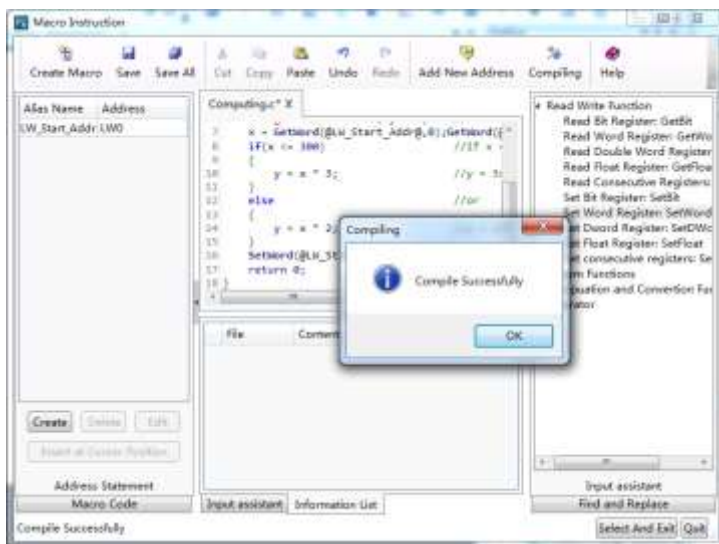

VEDA HCT User Manual

If compiling fails, you should modify the macro codes according to the error messages of the information list until compiling is successful.

Click the Save button "  " on the shortcut toolbar to save the macro codes. Then close the macro window.

5.4.2.4 Execute the macro

There are many ways to execute the macro. You can set macros for the buttons, the notification settings in the component control settings and timer function.

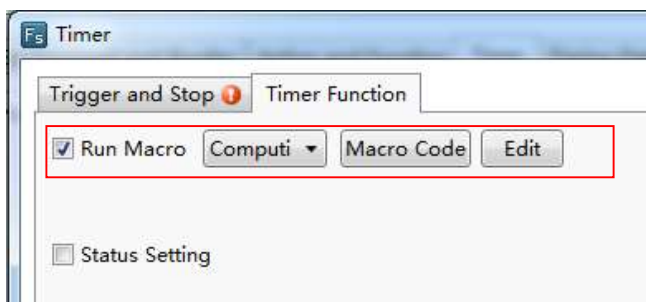
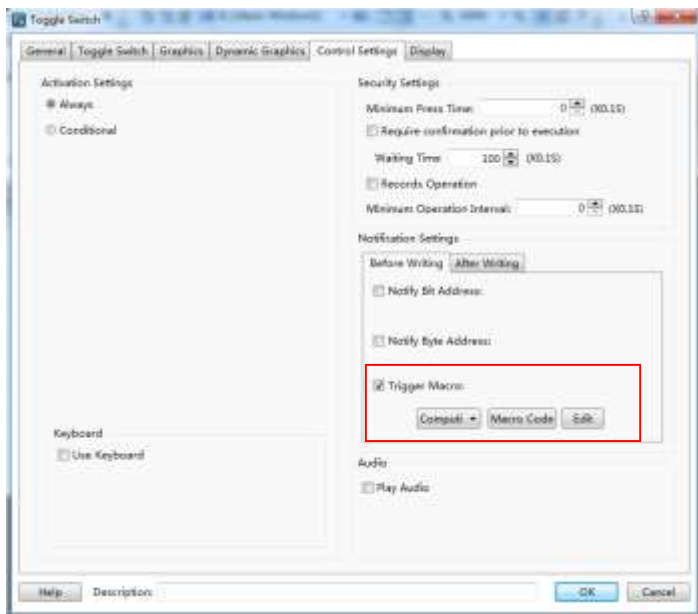
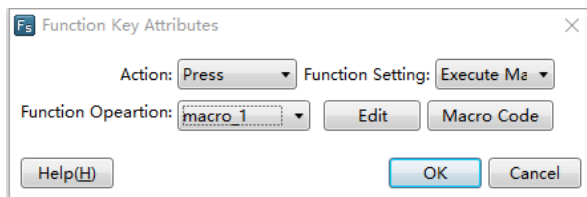

VEDA HCT User Manual

In this example, execute the “Computing” macro when the input value changes by using the timer function. See settings as shown as below. The detailed using method of the timer component, please refer to: [Detailed manual/Component/Timer and Data Transmission/Timer](#).

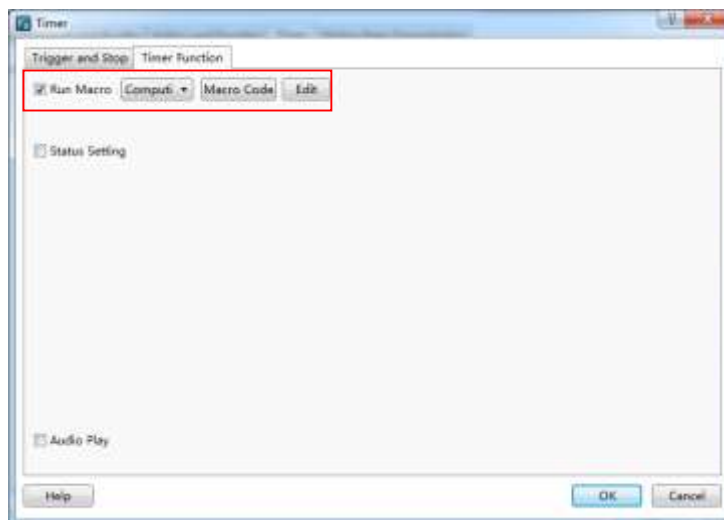
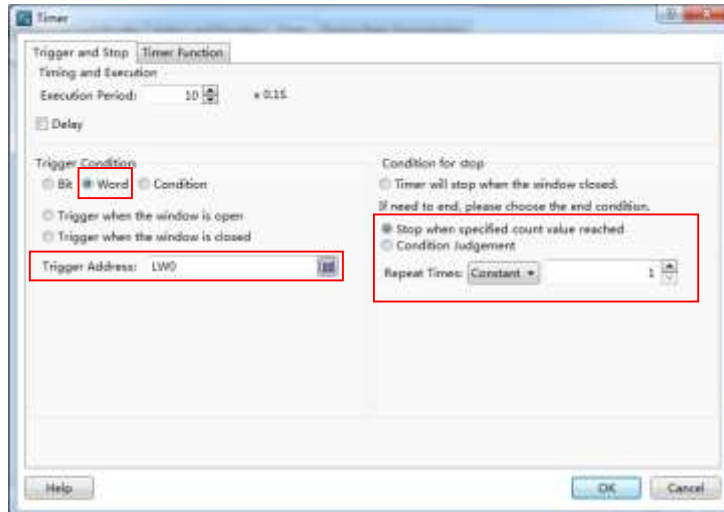

5.4.2.5 Offline Simulation

Offline simulation can be executed to verify the correction of the function after the above steps are finished.

Click the "Offline Simulation" button  on the shortcut tools bar.

VEDA HCT User Manual

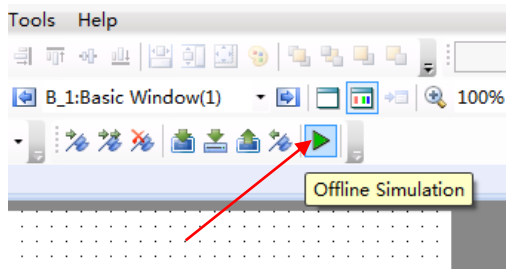

A “Clear Records” message box will pop up. After clicking the button “OK”, the project will compile.

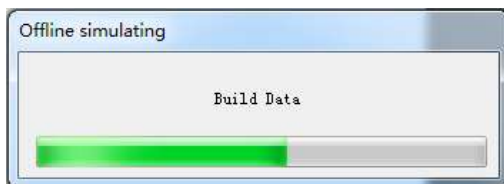

The project compiling needs a little time. There is a progress bar to indicate the compiling progress. The simulator window (Emulator) will open automatically after the compiling is finished.



VEDA HCT User Manual

Input the value 100 to LW0. The output value of LW1 will be 300 according to the rules that the output value will be 3 times as much as the input value if the input value is less than or equal to 300.



Input the value 400 to LW0. The output value of LW1 will be 800 according to the rules that the output value will be 2 times as much as the input value if the input value is not less than or equal to 300.



5.5 Online software upgrade

If the user can not receive the automatic update reminders, the following solutions are given.

(1) Execute "cmd" in the administrator mode. Please input the following commands.

```
rmdir /s /q "%userprofile%\wc"
```

```
rmdir /s /q "%appdata%\wyUpdate AU"
```

VEDA HCT User Manual

(2) Reopen the VEDA HCT software.

6 Appendix

6.1 The Use of Register

The Type of HMI register includes "Word" register and "bit register".

6.1.1 Word Register

LW: An internal "Word Register" in HMI. The data is lost when the power is off. The register address range is 0 - 799,999.

RW: An internal "Word Register" in HMI. The data can be saved if power is off. The register address range is 0 - 524288.

SRW: A special internal "Word Register" in HMI. The register address range is 0 - 11023. You can click the "System Register" button and open the "System Special Function Register" to get the specific function of each SRW register when you use the component such as "Numeric Display". For example, SRW0 ~ 7 saves the system time. The "Description" introduces the function of the selected register.

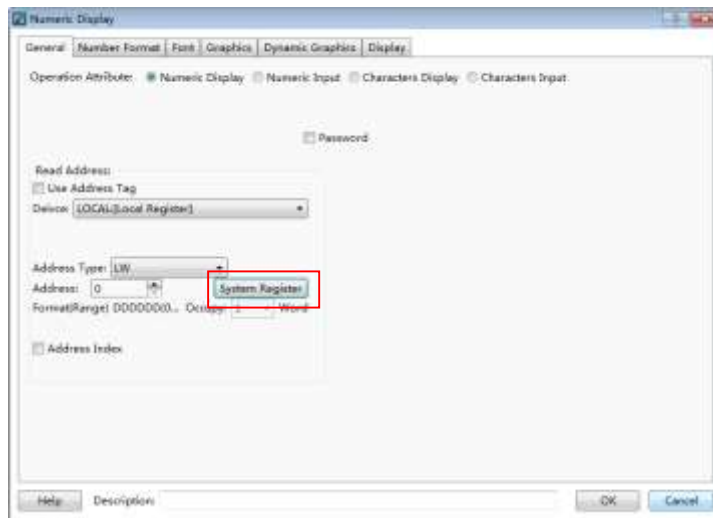

VEDA HCT User Manual

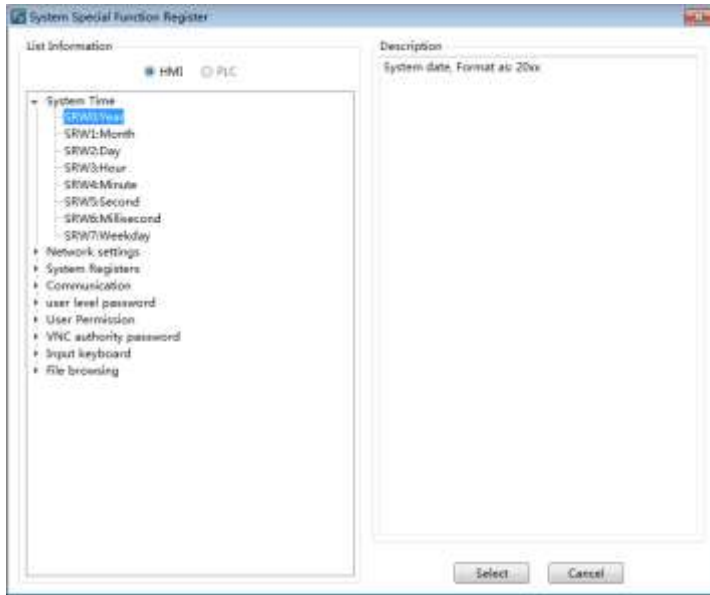

6.1.2 Bit Register

LB: An internal "Bit Register" in HMI. The data is lost when the power is off. The register address is 0 - 799,999.

SRB: A special internal "Bit Register" in HMI. The register address range is 0 - 11023. You can click the "System register" button and open the "System Special Function Register" to get the specific function of each SRB register when you use the component such as "Bit Set". The "Description" introduces the function of the selected register. For example, SRB16 is ON when the touch screen is pressed.

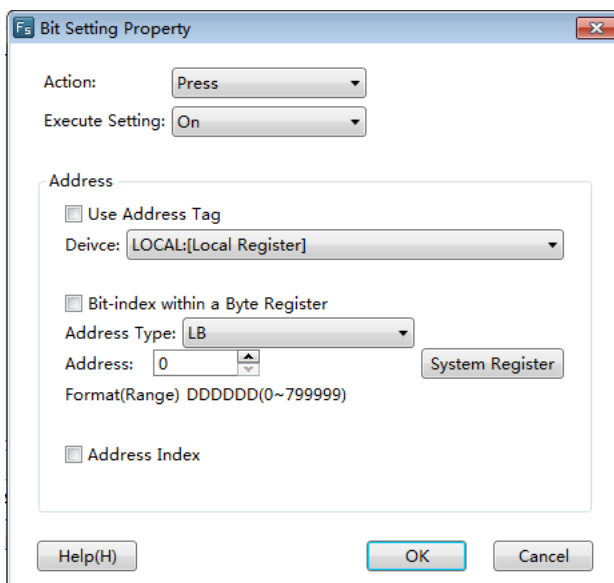

VEDA HCT User Manual

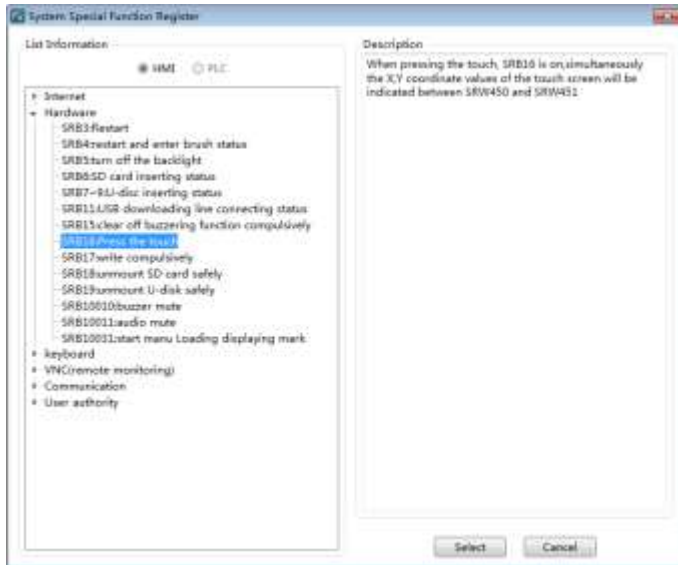

Note: "Word Register" and "Bit register" in HMI are two different areas, so the address does not overlap. For example, LW0 and LB0 are two registers that they are not related. SRW0 and SRB0 are also two different special system registers. But each word register can be divided into 16bit registers. For example, LW0 can be divided into 16bit registers: LW0.0 ~ 0.15.

6.2 Built-in Functions

You can find the built-in functions when you create or edit Micros. They can be used by calling directly.

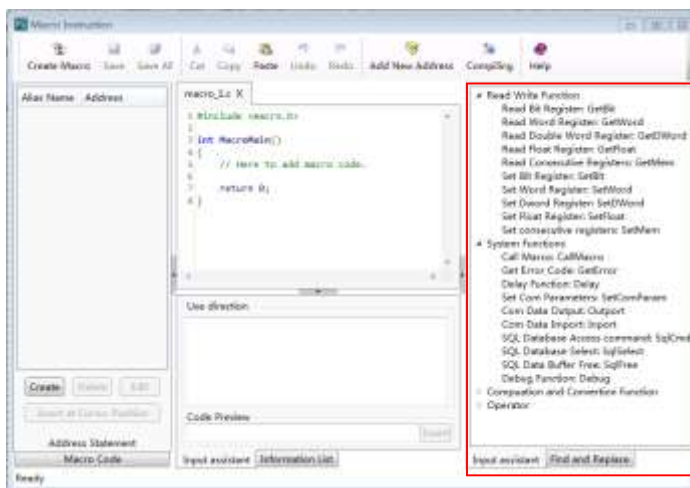

6.2.1 Read Write Function

6.2.1.1 Read Bit Register: GetBit

boolGetBit(@Address Alias@,Address Offset):

VEDA HCT User Manual

Read one bit from designated register address.

@Address Alias@: Select a bit address register

Address Offset: An unsigned integer, Read Address=The address specified by @Address Alias@+Address Offset

Return Value: BOOL, the value of the bit which was read

Error Information:

Get the error code using GetError() function.

```
int error=GetError();
```

Example:

```
bool power=GetBit( @power_on@,2 );
```

In this example, power on is the alias of LB0, so the function GetBit will read the bit value from LB2 and return to a BOOL variable power.

6.2.1.2 Read Word Register: GetWord

```
unsigned short GetWord( @Address Alias@, Address Offset );
```

Read one word from specified register address.

@Address Alias@: Select a word address register

Address Offset: An unsigned integer, Read Address=The address specified by @Address Alias@+Address Offset

Return Value: Unsigned Short Type, the value of the word which was read

Error Information: Get the error code using GetError() function.

```
int error=GetError();
```

Example:

```
unsigned short speed=GetWord( @Speed@,3 );
```

VEDA HCT User Manual

The Alias @Speed@ represents the register LW0 in this example, so the target word register is LW3 (LW0+3), the value of LW3 is returned to an Unsigned Short variable named "speed".

```
short speed = (short) GetWord(@Speed@,3); //If use signed number, you can use force conversion.
```

6.2.1.3 Read Double Word Register: GetDWord

```
Unsignedint GetDWord( @Address Alias@, Address Offset );
```

Read a double word from a specified register address.

@Address Alias@: Select an address register (word or double word).

Address Offset: An unsigned integer, Read Address=The address specified by @Address Alias@+Address Offset.

Return Value: unsignedint type, the value of the double word which was read. If the address is word type, the function will return two consecutive words.

Error Information: Get the error code using GetError() function.

```
int error=GetError();
```

Example:

```
unsignedint speed=GetDWord( @Speed@,3 );
```

The Alias @Speed@ represents the register LW0 in this example, so the target word register is LW3 and LW4, the value of LW3 and LW4 are returned to a Unsigned int variable named "speed".

```
int speed = (int) GetDWord(@Speed@,3); //If use signed number, you can use force conversion.
```

6.2.1.4 Read Float Register: GetFloat

```
floatGetFloat( @Address Alias@,Address Offset );
```

Read a single precision float number from specified register address.

@Address Alias@: Select a address register (word or double word)

VEDA HCT User Manual

Address Offset: An unsigned integer, Read Address=The address specified by @Address Alias@+Address Offset

Return Value: float type, the value of the float number stored in the Word register or two consecutive word registers which are read.

Error Information: Get the error code using GetError() function.

```
int error=GetError();
```

Example:

```
float speed=GetFloat(@Speed@,3);
```

The Alias @Speed@ represents the register LW0 in this example, so the target word register is LW3 and LW4, the double word stored in LW3 and LW4 are returned to a float variable named "speed".

6.2.1.5 Read Consecutive Registers: GetMem

```
intGetMem( Array Pointer,@AddressAlias@,AddressOffset,Byte Number ):
```

Read consecutive words from specified registers.

Array Pointer: pointer type, point to a pre-defined array.

@Address Alias@: select a register as the beginning address, could be a bit type or word type register.

Address Offset: an unsigned int number. The read beginning address=The address specified by @Address Alias@ + Address Offset.

Number of Bytes: an unsigned int number, specifying how many bytes should be read. Please note: Number of Bytes = sizeof (Type of the Array) * (number of elements in the array). The upper limit of Number of Bytes is 20480.

Return Value: int type, 0-Failure, 1-Success.

Example:

```
unsigned short data[10];
```

```
int error = GetMem(data,@Array Data@,2,10*sizeof(unsigned short) );
```

VEDA HCT User Manual

In this example, @Array Data@ = LW0, so the function will return 10 words from the address starting from LW2.

```
char data[5];
```

```
int error = GetMem(data,@Array Data@,2,5):
```

@Array Data@ = LW0, so the function will read 3 words (each word contains 2 variables of char type, the higher half of the last word is invalid) and copy to the array named "data"

6.2.1.6 Set Bit Register: SetBit

```
intSetBit( @Address Alias@,AddressOffset,Set Value ):
```

Write a bool value into one bit of a designated register address.

@Address Alias@: Select a bit address register

Address Offset: An unsigned integer, Target Address=The address specified by @Address Alias@+Address Offset.

Set Value: BOOL, the value to be written into the designated bit register, 0 or 1.

Return Value: int type, 0-Failure, 1-Success.

Example:

```
int error=SetBit(@power@,2,1)
```

In this example, power is the alias of LB0, so the function SetBit will write "1" into the bit LB2.

6.2.1.7 Set Word Register: SetWord

```
intSetWord( @Address Alias@,AddressOffset,Set Value ):
```

Write one 16-bit number into a designated word register.

@Address Alias@: Select a word type address.

Address Offset: unsigned int, Target Address=The address represented by @Address Alias@+Offset.

Set Value: short type, the value to be written into the designated register.

Return Value: int type, 0-Failure, 1-Success.

VEDA HCT User Manual

Example:

```
short speed;
```

```
int error=SetWord(@Speed@,3,speed);
```

In this example, the alias @Speed@ refers to LW0, so the function will write the value of speed into the word register LW3 .

6.2.1.8 Set Double Word Register: SetDWord

```
boolSetDWord( @Address Alias@,AddressOffset,Set Value ):
```

Write one 32-bit number into a designated word register, the register could be a Dword register or two consecutive word registers.

@Address Alias@: Select a word or dword type address.

Address Offset: unsigned int, Target Address=The address represented by @Address Alias@+Offset.

Set Value: int type, the value to be written into the designated register.

Return Value: int type, 0-Failure, 1-Success.

Example:

```
unsignedint speed;
```

```
int error=SetDWord(@Speed@,3,speed);
```

In this example, the alias @Speed@ refers to LW0, so the function will write the value of speed into the word registers LW3 and LW4.

6.2.1.9 Set Float Register: SetFloat

```
intSetFloat( @Address Alias@,AddressOffset,Set Value ):
```

Write one single precision float number into a designated word register.

@Address Alias@: Select a word or dword type address.

Address Offset: unsigned int, Target Address=The address represented by @Address Alias@+Offset.

Set Value: float type, the float value to be written into the designated register.

VEDA HCT User Manual

Return Value: int type, 0-Failure, 1-Success.

Example:

```
float speed=3.14;
```

```
int error=SetFloat(@Speed@,3,speed):
```

In this example, the alias @Speed@ refers to LW0, so the function will write the value of speed into the dword registers consist of LW3 and LW4.

6.2.1.10 Set Consecutive Registers: SetMem

```
intSetMem( Array Pointer,@AddressAlias@,AddressOffset,Byte Number ):
```

Write the array data into consecutive registers.

Array Pointer: pointer type, point to a pre-defined array.

@Address Alias@: A register as the beginning address. It can be a bit type or word type register.

Address Offset: an unsigned int number. The read beginning address=The address specified by @Address Alias@ + Address Offset.

Number of Bytes: an unsigned int number, specifying how many bytes should be read.
Please note: Number of Bytes = sizeof (Type of the Array) * (number of elements in the array).
The upper limit of Number of Bytes is 20480.

Return Value: int type, 0-Failure, 1-Success.

Example:

```
unsigned short data[10];
```

```
int error = SetMem(data,@Array Data@,2,10*sizeof(unsigned short)):
```

In this example, @Array Data@ = LW0, so the function will copy 10 words to the 10 word register address starting from LW2.

```
char data[5];
```

```
int error = SetMem(data,@Array Data@,2,5):
```

VEDA HCT User Manual

@Array Data@ = LW0, so the function will copy the value from the array named "data" to 3 words starting from LW2(each word contains 2 variables of char type, the higher half of the last word is invalid)

6.2.2 System Functions

6.2.2.1 Call Macro: CallMacro

intCallMacro("Macro Name");

Call Designated Macro.

Macro Name: The content within the double quotes is the name of the macro being called, don't use any file name suffix.

Return Value: int type, the return value of the main function of the macro will be returned.

Example:

```
int error = CallMacro("Macro_1");
```

6.2.2.2 Get Error Code: GetError

intGetError();

Get error code.

No input parameters.

Return Value: int type, the corresponding error code.

0-Not executed

1-Success

2-Timeout

3-Error

4-Socket word error

5-Communication failure

Example:

VEDA HCT User Manual

```
int error =GetError();
```

6.2.2.3 Delay Function: Delay

Delay(ms):

Delay Function, the input parameter is the number of mili-seconds, unsigned int type.

Return Value: None.

Example:

```
Delay(1000);//Delay 1000ms.
```

6.2.2.4 Set Com Parameters: SetComParam

```
intSetComParam( Port Number,BaudRate,databit,stopbit,checkbit,communication mode);
```

Port Number: the ID of com port, unsigned int type. 0-COM1, 1-COM2, 2-COM3...

Baud Rate: the speed of communication, int type. e.g. 9600, 115200

Date bit: the number of bits used as data, int type, 7,8

Stop bit: the stop bit, int type, 1,2

Check bit: specify the way of checking, int type, 'n' or 110-no check, 'o' or 111-odd check, 'e' or 101-even check

Communication mode: set the mode of communication, int type, 0-232, 1-485-4w, 2-485-2w.

Return Value: 0-Failed, 1-Success.

Example:

```
int error=SetComParam(0,115200,8,1,'n',2);//COM1,485-2w, 115200,8,1,N.
```

6.2.2.5 Com Data Output: Output

```
intOutput( Port ID,BufferPointer,Data Quantity);
```

Please call the SetComParam function to initialize the serial port before call this function.

Port ID:the ID of com port, unsigned int type. 0-COM1, 1-COM2, 2-COM3...

VEDA HCT User Manual

Buffer Pointer: the pointer to the buffer array.

Data Quantity: unsigned short, the number of data to be sent out.

Return Value: the number of bytes of the output data.

Example:

```
unsigned char send_buff[]="Hello world!";
```

```
int error=Outport(1,send_buff,12);
```

6.2.2.6 Com Data Import: Inport

```
intInport( Port ID,BufferPointer,BufferSize,Timeout Limit):
```

Please call the SetComParam function to initialize the serial port before call this function.

Port ID:the ID of com port, unsigned int type. 0-COM1, 1-COM2, 2-COM3...

Buffer Pointer: the pointer to the buffer array

Buffer Size: The length of buffer being read, the size will be returned when read complete, maximum buffer size is 4096.

Timeout Limit: unit mS, if no data is received within nmS, or buffer is full, the receive function will return.

Return Value: the number of data actually be read, return value of -1 indicates error.

Example:

```
unsigned char recv_buff[];
```

```
intdata_count=Inport(1,recv_buff,16,10);
```

6.2.2.7 SQL Database Access Command: SqlCmd

```
intSqlCmd(Database file ID, SQL command string pointer);
```

Database file ID: int type, 0 represents the database for historical and alarm events; 1,2,3...represent the database file corresponding to the data sampling IDs.

SQL command string pointer: char type, pointer to the SQL command strings.

VEDA HCT User Manual

Return Value: int type, 1-Success, 0-Failed.

6.2.2.8 SQL Database Select: SqlSelect

intSqlSelect(Database file ID, SQL command string pointer, Buffer of inquiry results, Number of Rows Returned, Number of Columns Returned);

Database file ID: int type, 0 represents the database for historical and alarm events; 1,2,3...represent the database file corresponding to the data sampling IDs.

SQL command string pointer: char type, pointer to the SQL command strings.

Buffer of inquiry results: char type, pointer.

Number of Rows Returned: int type, the number of rows of the returned results.

Number of Columns Returned: int type, the number of columns of the returned results.

Return Value: int type, 1-Success, 0-Failed.

Example:

```
char **pResult;  
  
intRow,Col;  
  
int err=SqlSelect(2,"xxx",pResult,Row,Col);  
  
SqlFree(pResult);
```

6.2.2.9 SQL Data Buffer Free: SqlFree

intSqlFree(Pointer to Database inquiry buffer);

Pointer to database inquiry buffer: Char Array pointer.

Return Value: int type, 1-Success, 0-Failure.

Example:

```
char **pResult;  
  
intRow,Col;  
  
int err=SqlSelect(2,"xxx",pResult,Row,Col);  
  
SqlFree(pResult);
```

VEDA HCT User Manual

6.2.2.10 Debug Function: Debug

```
void Debug( Port ID,Format String,Var1,Var2...);
```

Please call the SetComParam function to initialize the serial port before call this function. But serial port initialization is not needed if only debug in the simulation window.

Port ID: the ID of com port, unsigned int type. 0-COM1, 1-COM2, 2-COM3...

Format String: the format of output string, usage is same as printf in C language.

Variables: the name of variables corresponding to the output strings, same usage as printf function in C programming language.

The format is defined below, [] indicates optional elements.

```
%[Designated Parameter][Identifier][Width][.Precision]Designator
```

If you want to output '%', please use '%%'. 1- Define the direction of processing. Negative sign means the direction is from backend to the beginning. 2- The word element for space filling. 0 means fill 0s to the spaces. 3- The width of the character. 4- Precision, the number of decimal places.

Character Conversion:

%% Print % sign, no conversion

%c Convert the integer to corresponding ASCII character

%d Convert the integer to decimal number

%f Convert to floating number

%o Convert the integer to Octal numbers

%s Convert the integer to string

%x Convert the integer to lower case hexadecimal number

%X Convert the integer to upper case hexadecimal number

Example:

```
intitest=12;
```

```
floatftest=65.4321;
```

VEDA HCT User Manual

```
Debug(0,"itest=%d\n ftest=%2.3f\n",itest,ftest);
```

Output Result:

```
itest=12
```

```
ftest=65.432
```

6.2.3 Computation and Conversion Function

6.2.3.1 CRC check function, 16Bit

```
unsigned short CRC16( Array Pointer , Computation Length );
```

Array Pointer: point to the array being processed.

Computation Length: the number of bytes being processed.

Return Value: 16-bit CRC check value.

Example:

```
unsigned char data[]={5,6,3,2,18};
```

```
unsigned short crc16=CRC16(data,5);
```

6.2.4 Operator

6.2.4.1 Assignment Operator

=

Assignment operator for assignment.

Example:

```
inti;
```

```
i=100;
```

VEDA HCT User Manual

6.3 System Register Bits and Words List

SRB0	Network connection status SRB0=0: no connection. SRB0=1: network connection is normal
SRB1	SRB1=1: Reset IP address immediately/re-obtain dynamic IP address immediately
SRB3	SRB3=1: Reboot the system
SRB4	SRB4=1: reboot and enter BOOT state (refresh state)
SRB5	SRB5=0: light up the backlight, SRB5=1: turn off the backlight
SRB6	SRB6=0: No SD card inserted, SRB6=1: SD card inserted
SRB7	SRB7~9=0: no USB flash drive inserted, SRB7~9=1: USB flash drive inserted, SRB7~9 correspond to USB 1~3 inserted USB flash drives respectively
SRB10	SRB10=0: Function key input lowercase characters, SRB10=1 function key input corresponding uppercase characters
SRB11	SRB11=0: USB download cable is not connected, SRB11=1: USB download cable is connected
SRB12	SRB12=1: mouse use allowed SRB12=0: mouse disabled

VEDA HCT User Manual

SRB13	SRB13=0: alphabetic keyboard displays letters, SRB13=1 alphabetic keyboard displays numbers and symbols
SRB14	SRB14=0: use English input, SRB14=1: use Pinyin input
SRB15	SRB15=1: force disable alarm beeping
SRB16	When the touch is pressed, SRB16 turns ON and the X and Y coordinates of the touch position are displayed in SRW450 and SRW451.
SRB17	When SRB17 is ON, RW, recipe and other power-down hold data is written immediately. The default is OFF, when buffered writing is used, so if power is suddenly lost, the last few seconds to a minute of data will be lost.
SRB18	If SRB18 is set to 1, the system will safely eject the SD card, to reuse the SD card, please re-plug the SD card or reboot the HMI, you can use SRB6 to check if the SD card has been ejected.
SRB19	Use SRB7 to check if the USB stick has been ejected.
SRB20	After changing the COM1 communication setting, setting this position 1 will immediately apply the change. If this position is not set, it will only take effect after a reboot.
SRB21	After changing the COM2 communication mode setting, the change will be applied immediately to position 1. If this

VEDA HCT User Manual

	position is not set, the change will only take effect after a restart.
SRB22	After changing the COM3 communication mode setting, the change will be applied immediately to position 1. If this bit is not set, the change will only take effect after a restart.
SRB23	After changing the COM4 communication mode setting, the change will be applied immediately to position 1. If this position is not set, the change will only take effect after a restart.
SRB30	SRB30=1: User rights login
SRB31	SRB31=1: Logout of user rights
SRB32	SRB32=1: Add user rights
SRB33	SRB33=1: Delete user rights
SRB34	SRB34=1: Change the password of the current user rights
SRB35	SRB35=1: revert to user information of the configuration project
SRB50	Changes to box input IO point X0 will be reflected to this value
SRB51	Changes to the box input IO point X1 will be reflected to this value

VEDA HCT User Manual

SRB52	Changing the value of register SRB52 will change the output state of the box Y0 point
SRB53	Changing the value of register SRB53 will change the output state of the box at point Y1
SRB70	SRB70=1:Acknowledge all current alarm events
SRB71	SRB71=1:Acknowledge all historical alarm events
SRB72	SRB72=1:Clear the acknowledged current events
SRB73	SRB73=1: Clear restored historical events
SRB101	SRB101=1: Execute the display sub-macro for all components
SRB102	SRB102=1: Customized uppercase characters for Korean input method
SRB103	SRB103=1: File browse path set by SRW300 takes effect
SRB104	SRB104=1: Disable scrolling input function for text elements
SRB105	SRB105=1: No history is saved for 33~64 group alarms
SRB106	SRB106=1: Trend graph hides out-of-range sampling points
SRB110	Confirm rebind when rebooting the device (valid only after reboot if current flink serial number and bound serial number do not match and first trigger)
SRB111	SRB111=1, rebind flink successful

VEDA HCT User Manual

SRB112	SRB112=1, power on detects that the current flink and the bound flink serial number do not match
SRB113	Already bound HMI, when no flink flag bit is connected 1: no flink inserted 0: flink inserted
SRB114	Internal use
SRB115	Synchronized with the "Connected flink" field of the configuration project, =1 means used, =0 means not used, read only.
SRB120	Network connection status of Ethernet 2 SRB120=0: no connection; SRB120=1: network connection normal
SRB121	SRB121=1: Immediately reset the IP address of Ethernet 2 / immediately reacquire the dynamic IP address
SRB122	WiFi immediately re-writes configuration and reconnects
SRB123	WiFi connection status triggers a refresh
SRB124	Start WiFi network scan
SRB125	Cellular network status triggers refresh
SRB126	SRB126=1: immediately resets all network parameters back to the same as the in-project settings (obtained from fshmi.bin)
SRB127	Triggers saving of internet access, and url
SRB128	Triggers saving of apn etc.

VEDA HCT User Manual

SRB140	<p>currently running project allows upload flag, read-only, SRB140=1: upload allowed; SRB140=0: upload not allowed</p>
SRB141	<p>Current running project allows decompile flag, read-only, SRB141=1: decompile allowed; SRB141=0: decompile not allowed.</p>
SRB142	<p>Current running project has set download password flag, read-only, SRB142=1: download password set; SRB142=0: no download password set.</p>
SRB143	<p>Current running project has set the developer password flag, read-only, SRB143=1: developer password set; SRB143=0: developer password not set.</p>
SRB144	<p>System recovery, restores the HMI to the state of waiting for the configuration project to be downloaded, write-only. SRB144 = 1: performs system recovery; SRB144 = 0: no action.</p>
SRB147	<p>System bit register, SRB147 to 1, triggers start of fshmi.logo file update and logo replacement; by trigger success floader to 0. Check if the replacement is successful, using SRW70, out of error prompt.</p>
SRB150	<p>SRB150: control the user rights username and password byte allocation method.</p>

VEDA HCT User Manual

	<p>SRB150=0, SRW400 starts with 16 words for username and SRW416 starts with 4 words for password.</p> <p>SRB150=1, SRW400 starts with 12 words for the user name and SRW412 starts with 8 words for the password.</p>
SRB10000	<p>Power-down holding register, SRB10000=0: automatically obtain IP address (DHCP); SRB10000=1: statically assign IP address</p>
SRB10010	<p>SRB10010=0: buzzer enable, SRB10010=1: buzzer disabled</p>
SRB10011	<p>SRB10011=0: play sound normally, SRB10011=1: mute</p>
SRB10012	<p>SRB10012=0: enable five-finger screen grab to return to main window blinking, SRB10012=1: disable five-finger screen grab to return to main window</p>
SRB10013	<p>SRB10013=0: Allow modification of system time</p> <p>SRB10013=1: Disable modification of system time</p>
SRB10014	<p>SRB10014=1: keyboard focus left/right movement by pixel</p> <p>SRB10014=0: Keyboard focus left/right movement by component addition order</p>
SRB10015	<p>SRB10015=1: disable turning off the backlight or turning down the brightness when the alarm is not restored</p>
SRB10016	<p>SRB10016=1: Enable keyboard arrow keys to control mouse movement and enter key to control left click</p>

VEDA HCT User Manual

SRB10020	<p>SRB10020=0: disable VNC, SRB10020=1: enable VNC;</p> <p>SRB10020=0: disable VNC</p> <p>SRB10020=1: VNC enabled; power down save</p>
SRB10021	<p>SRB10021=0: Remote VNC can control interface;</p> <p>SRB10021=1: Remote VNC is display only, no control; power down save</p>
SRB10022	<p>Read/write, power-down hold register, SRB10022=0: automatically obtain IP address (DHCP); SRB10022=1: statically assigned IP address (Ethernet 2)</p>
SRB10030	<p>Disable register power-up initialisation: when set to 1, power-up does not immediately initialise all register values.</p> <p>Valid for the case of variable station numbers.</p>
SRB10031	<p>SRB10031=1 : loading string is not displayed at boot,</p> <p>SRB10031=0 : loading string is displayed at boot</p>
SRB10032	<p>Used by the template as a control bit to pop up the program update window. SRB10032=1 : pop up, SRB10031=0 : no action</p>
SRW0	System date: year in the format 20xx
SRW1	System date: month
SRW2	System date: day
SRW3	System time: hour

VEDA HCT User Manual

SRW4	System time: minutes
SRW5	System time: seconds
SRW6	System time: milliseconds
SRW7	System date: day of week
SRW10	HMI MAC address, SRW10~15, the lower address of each WORD indicates a MAC segment. Read only, not rewritable.
SRW20	Product model ID, SRW20~21, ID number of the product model
SRW24	Factory date, SRW24~26, the date the product was shipped from the factory, corresponding in order: year: month: day
SRW27	HMI current color depth, 16-16 bit color, 24-24 bit color, read only
SRW30	Software version number, SRW30~36, in order: Boot, Kernel, Rootfs, Floader, Fgui, Fcs, Fds
SRW40	Product hardware serial numbers, SRW40~45, 96 digits in total, unique worldwide
SRW50	Used for operation confirmation in security settings: 1 - Confirm operation execution, 2 - Cancel operation
SRW60	Communication message code, communication timeout, error, etc., occupies one word register
SRW61	Device number of the communication message

VEDA HCT User Manual

SRW62	Port number where the communication message is located
SRW63	The PLC station number where the communication message is located
SRW64	Set the communication timeout or error pop-up time in seconds (0 means default 3 seconds)
SRW65	Set the time to hold the system prompt pop-up in seconds (0 means default 3 seconds)
SRW70	<p>System information codes.</p> <p>1: Input overrun.</p> <p>2: processing in progress.</p> <p>3: operation successful.</p> <p>4: data transfer out of bounds.</p> <p>5: Out of memory.</p> <p>6: macro execution error.</p> <p>7: password input error.</p> <p>8: failed to connect to the server.</p> <p>9: operation failure.</p> <p>10: current user rights do not match.</p> <p>11: successful logout.</p> <p>12: user repeatedly logged in.</p> <p>13: SD card not detected.</p>

VEDA HCT User Manual

14: U-drive 1 not detected.

15: U-disk 2 not detected.

16: database upgrade in progress, please wait.

17: query in progress, please wait.

18: Printing failed.

19: Printing busy.

20: preparing report for printing.

24: HMI remaining space is less than 3M.

25: SD card with less than 3M remaining space.

26: USB1 remaining space less than 3M.

27: insufficient space left for USB2 of 3M.

30: Media file format error.

31: media file playback failure.

32: password setting too short.

33: media playback not supported by 16-bit color.

34: unsupported video encoding format.

35: capacitive touch does not need to be calibrated (only

Allwinner platforms will give this indication).

128: operation successful.

137: file does not exist.

138: wrong file type.

VEDA HCT User Manual

	<p>139: operation failed.</p> <p>140: file already exists.</p> <p>141: user password error.</p> <p>142: Insufficient memory on screen.</p> <p>143: insufficient memory on SD card, USB stick.</p> <p>144: Incorrect developer password.</p> <p>145: target model restricted, please change to the correct HMI.</p> <p>146: current HMI model does not support this function.</p> <p>147: upgrade file not detected.</p> <p>148: abnormal upgrade file.</p> <p>149: the upgrade file version is the same as the current version.</p> <p>150: Upgrade in progress, please wait...</p> <p>151: Kernel upgrade failed.</p> <p>152: kernel upgrade successful.</p>
SRW76	SRW76~77: Double-word type, showing the maximum space (in bytes) of the HMI disk
SRW78	SRW78~79: double word type, displaying the used space of HMI disk (in bytes)

VEDA HCT User Manual

SRW80	SRW80~81: Double-word type, displaying the amount of RAM memory currently occupied by the system
SRW84	SRW84~85: Double-word type, displaying the upper limit of the amount of RAM memory available to the system
SRW88	Display the time interval (in milliseconds) of the system cyclic scan
SRW96	SRW96~99: 4 words, developer password
SRW100	Enter the user registration password for verification. Occupies SRW100~103, 4 words, please use the text input element to read or display the password value
SRW104	Read-only register, display the current password level of the basic window. SRW104, occupies 1 word
SRW105	Forced change of the current password level, note that it can only be switched from a high level to a low level. SRW105, occupies 1 word
SRW120	SRW120~135; COM1 connected device communication status by station number, occupies 16 words, each word has 16 bits, corresponding to station number 0~255. e.g. SRW120 with Bit3 of 1 means that the serial port is connected to station number 3 device communication error.

VEDA HCT User Manual

SRW140	<p>SRW140~155;COM2 connected device communication status by station number, occupies 16 words, each word has 16 bits, corresponding to station number 0~255. e.g. SRW140 with Bit3 of 1 means the serial port connected device of station number 3 has communication error.</p>
SRW160	<p>SRW160~175;COM3 connected device communication status by station number, occupies 16 words, each word has 16 bits, corresponding to station number 0~255. e.g. SRW160 with Bit3 of 1 means the serial port is connected to station number 3 device communication error.</p>
SRW180	<p>SRW180~195; COM4 connected device communication status by station number, occupying 16 words, each word 16 bits, corresponding to station number 0~255. e.g. SRW180 with Bit3 of 1 means the serial port connected device communication error of station number 3.</p>
SRW200	<p>SRW200~215, 16 words in total, are generally used as character display elements to display the input process of characters when the keyboard is popped up</p>
SRW220	<p>SRW220~235, 16 characters in total, generally used as a character display element to show the maximum value of the input range of the current value input element</p>

VEDA HCT User Manual

SRW240	SRW240~255, 16 characters in total, generally used as a character display element to show the minimum value of the input range of the current numeric input element
SRW260	SRW260 to 275, 16 characters in total, generally used as a character display element to show the historical value of the current numeric input before it enters the input state
SRW280	Input keyboard control word, currently only SRW280.0 is valid, SRW280.0 is ON means that the alternative word window coordinates (SRW281,SRW282) are in effect SRW280.0 is OFF to indicate that the alternative word window coordinates are fixed at the page coordinates (0,0).
SRW281	Single character, input method alternative window x-coordinate, relative to keyboard window
SRW282	Single character, Y-coordinate of input method alternative window, relative to keyboard window
SRW283	Input method type, 0 - Pinyin input method, 1 - Korean input method
SRW300	SRW300~349, total 50 characters, general use character component, displaying the absolute path string currently selected by the file browser component

VEDA HCT User Manual

SRW350	SRW350~389, 40 characters, general character element, displays or enters the file name of the file browser element, excluding the path
SRW390	SRW390, actions performed after confirmation of the document viewing element. 0-cancel or no operation. 1-Import of the project to the HMI. 2-Export from HMI to SD card or USB stick. 3-Importing recipes to the HMI. 4-Export of recipes to SD card or USB stick. 5-Other file operations
SRW391	Clean-up operations done before importing the project to the HMI. BIT0: Clears the RW, BIT1: Clears the recipe BIT2: Clears data sampling records and alarm event history BIT3: Clears special register values
SRW392	Result of the import and export operation. 128: Operation successful 0x80 137: File does not exist 0x89 138: File type error 0x8a

VEDA HCT User Manual

	<p>139: Operation failed 0x8b</p> <p>140: File already exists 0x8c</p> <p>141: User password error 0x8d</p> <p>142: Insufficient HMI memory space 0x8e</p> <p>143: External memory storage space is insufficient 0x8f,</p> <p>132: U disk format is not correct, please replace the U disk with Fat format 0x84</p> <p>144: Developer password error 0x90</p> <p>145: Screen does not match the model selected by the project 0X91</p>
SRW394	<p>The user uploads a password store that takes up 4 characters, the password can be any combination of 0 to 9 and supports a maximum of 8 numbers. Note that for example 0123 and 00123 are different passwords. Occupies SRW394~397, 4 words in total, please use ASCII components to read or display the password value</p>
SRW398	<p>Minimum length of user password</p>
SRW399	<p>User number for user rights login</p>
SRW400	<p>User permission user name string, occupies 16 characters, you can enter 16 Chinese characters or 32 English and numeric characters</p>

VEDA HCT User Manual

SRW416	<p>Password for user rights setting, occupies 4 characters, password can be any combination from 0 to 9, maximum support 8 numbers. Note that for example, 0123 and 00123 are different passwords. Use ASCII input, please use the text input element to operate</p>
SRW420	<p>Double word, shows the current user rights, each bit corresponds to a BIT, BIT0 corresponds to permission 1, BIT1 corresponds to permission 2...</p>
SRW422	<p>Double word to set the new user rights, each bit corresponds to a BIT, BIT0 corresponds to right 1, BIT1 corresponds to right 2...</p>
SRW424	<p>Set the automatic logout time for new users (in minutes), 2 words</p>
SRW426	<p>Set the new password for the new user or the new password for the modified password, accounting for 4 characters, the password can be any combination from 0 to 9, the maximum number of numbers supported is 8. Note that for example, 0123 and 00123 are different passwords. Use ASCII input, please use the text input element to operate</p>
SRW430	<p>Set the confirmation password for adding a new user or changing a password, accounting for 4 characters</p>
SRW434	<p>Display of the currently logged in user name, 16 characters</p>

VEDA HCT User Manual

SRW449	Delay time for issuing a super read after numeric entry or clicking a switch, time value = set value * 100 ms. Default value 0 for 100 ms.
SRW450	SRW450: When the touch is pressed, SRB16 is set to ON and SRW450 is the X coordinate value of the current touch point
SRW451	SRW451: When the touch is pressed, SRB16 is set to ON and SRW451 is the Y-coordinate value of the current touch point
SRW456	The key code value of the current key press, occupies 2 words
SRW458	Set the determination time of USB keyboard key release, time value = set value * 200 ms. SRW458 default value 0, means 200 ms.
SRW460	The serial number of the box/screen, accounting for 12 characters, 6 characters in total
SRW466	Box/screen password, 4 characters, 2 words
SRW480	System prompt masking bit, 16 characters in total. SRW480.x is the ON masking SRW70=x corresponding to the prompt. For example: SRW480.1 shield input over limit, SRW480.F shield not detected U disk 2, SRW481.0 shield database upgrade in progress.

VEDA HCT User Manual

SRW496	<p>Communication prompt masking bits (SRW496.1 is ON to mask communication timeout prompts, SRW496.2 to mask communication error prompts)</p>
SRW630	<p>SRW630~633; Network PLC communication status bits, 4 single words indicate the status of up to 63 remote PLCs, a bit value of 1 indicates that the corresponding remote PLC communication is abnormal, a value of 0 indicates that the corresponding remote PLC communication is normal or unused.</p> <p>For example, a value of 1 for SRW630.1 indicates that the first remote PLC is communicating abnormally, and a value of 1 for SRW630.2 indicates that the second remote PLC is communicating abnormally.</p>
SRW640	<p>SRW640~655, network PLC communication status bits, set to 1 means the corresponding network PLC communication is abnormal, set to 0 means the corresponding network PLC communication is normal or not in use. For example, SRW640.0 is 1, which means the first network PLC communication is abnormal, SRW640.1 is 1, which means the second network PLC communication is abnormal.</p>

VEDA HCT User Manual

SRW699	Display the length of the scan gun input characters (in bytes), the user needs to clear this length value after reading the content of SRW700
SRW700	SRW700~799:Display the content of the scan gun input characters
SRW800	<p>COM1 automatically blocked station number: SRW800~815; occupies 16 words, each word has 16 bits, one bit corresponds to one station number, indicating station number 0~255. 1 - the corresponding station number has been automatically blocked communication; 0 - the corresponding station number is normal communication.</p> <p>Example: Bit 3 of SRW800 is 1, which means that the station number 3 device connected to COM1 has been blocked automatically due to abnormal communication. This register is valid when SRW10230 is set to allow automatic blocking.</p>
SRW820	<p>COM2 is automatically blocked station number: SRW820~835; occupies 16 words, each word has 16 bits, one bit corresponds to one station number, indicating station number 0~255. 1 - the corresponding station number has been automatically blocked communication; 0 - the corresponding station number is normal communication.</p>

VEDA HCT User Manual

	<p>Example: Bit 3 of SRW820 is 1, which means that the station number 3 device connected to COM2 is blocked automatically due to abnormal communication. This register is valid when SRW10280 is set to allow automatic blocking.</p>
<p style="text-align: center;">SRW840</p>	<p>COM3 is automatically blocked station number: SRW840~855; occupies 16 words, each word has 16 bits, one bit corresponds to one station number, indicating station number 0~255. 1 - the corresponding station number has been automatically blocked communication; 0 - the corresponding station number is normal communication.</p> <p>Example: Bit 3 of SRW840 is 1, which means that the station number 3 device connected to COM3 has an abnormal communication and is automatically blocked. This register is valid when SRW10330 is set to allow automatic blocking.</p>
<p style="text-align: center;">SRW860</p>	<p>COM4 is automatically blocked station number: SRW860~875; occupies 16 words, each word has 16 bits, one bit corresponds to one station number, indicating station number 0~255. 1 - the corresponding station number has been automatically blocked communication; 0 - the corresponding station number is normal communication.</p>

VEDA HCT User Manual

	<p>Example: Bit 3 of SRW860 is 1, which means that the station number 3 device connected to COM4 has been blocked automatically due to abnormal communication. This register is valid when SRW10380 is set to allow auto-masking.</p>
SRW880	<p>Ethernet communication automatically blocked devices: SRW880~895; occupies 16 words, each word has 16 bits, one bit corresponds to one Ethernet device, indicating the 0th to 255th device in the network PLC setting, blocking communication by IP to close the channel.</p> <p>1 - the IP set for the corresponding device has been automatically blocked from communication; 0 - the corresponding device is communicating normally.</p> <p>Example: Bit3 of SRW880 is 1, which means that the 3rd Ethernet device is communicating abnormally and the IP set is automatically blocked. This register is valid when SRW10518 is set to allow auto-masking.</p>
SRW900	<p>HMI MAC2 address, assigned to Ethernet 2, SRW900~905, the lower address of each WORD indicates a MAC segment.</p> <p>Read only, not rewritable.</p>
SRW1020	<p>Box online status, 1: box online, 0: box offline</p>
SRW1021	<p>Box network type, 1: Ethernet, 2: GPRS, 4: WIFI, 5: 4G</p>
SRW1022	<p>Box unlimited signal strength: 0 min, 8 max</p>

VEDA HCT User Manual

SRW1000	SRW1000~1001, double word (unit hundred milliseconds). 1 is accumulated every hundred milliseconds starting from normal operation of GUI, zero is cleared for GUI reboot.
SRW1070	Display IoT MQTT function using driver version number, occupies 1 word, segmented value display, takes value 0~65535. version explanation: V a.b.c, SRW1070 = $a*1000+b*100+c$.
SRW1080	FS version number first field from left to right, read only, occupies 1 word, decimal unsigned number taking values from 0 to 15.
SRW1081	FS version number, second field from left to right, read-only, occupies 1 word, decimal unsigned number in the range 0 to 15.
SRW1082~1083	FS version number, third field from left to right, read-only, occupies 2 characters, decimal unsigned number in the range 0 to 16777215.
SRW1090	Product model ID, SRW1090~1091, the ID number of the product model. in ASCII string form. See SRW20 for numeric form.
SRW1092~1093	Internal use
SRW1094	Displays the product hardware version number, corresponding to the hardware version number area of the

VEDA HCT User Manual

	EEPROM or eMMC memory, occupying 1 word. Numeric form, takes values from 0 to 65535.
SRW1161	Error code for the address mapping function. 0 = normal, -1 = error registering entry to FDS, 2 = mapping device driver communication timeout, 3 = mapping device driver communication error, 6 = FDS error, occupies 1 word, read only [modbus rtu sever and modbus tcp sever].
SRW10010	HMI IP address setting, power down hold, SRW10010~13, each WORD represents an IP segment. Read/write when static, read-only when dynamic.
SRW10014	HMI subnet mask setting, power down hold, SRW10014~17, each WORD represents one IP segment, read/write in static, read-only in dynamic.
SRW10018	HMI Gateway setting, power-down hold, SRW10018~21, each WORD represents an IP segment, read/write at static, read-only at dynamic.
SRW10022	DNS1 setting, power-down hold, SRW10022~25, each WORD represents an IP segment, read/write at static time, read-only at dynamic time.
SRW10026	DNS2 setting, power-down hold, alternate DNS, SRW10026~29, each WORD represents an IP segment, read/write at static, read-only at dynamic.

VEDA HCT User Manual

SRW10030	LAN IP address setting for local ETH, power-down hold, SRW10030~33, each WORD represents an IP segment. Read and write available when static.
SRW10039	Reset switch short pulse width setting, occupies 1 word, takes the value 0~200, unit milliseconds, default value 0, means 100 milliseconds. Effective around 5 seconds after modification
SRW10040	Screen saver time, SRW10040, the product after a period of time without operation, jump screen saver screen, power down to save
SRW10041	Backlight off time, SRW10041, after a period of no operation, the product automatically turns off the backlight, power off is saved
SRW10042	Turn down the brightness time, SRW10042, after a period of no operation, turn down the brightness, power down and save
SRW10050	Modify the current language number, SRW10050, and save it at power down. 0 means use language 1, 1 means that language 2 is used, and so on
SRW10051	SRW10051, rotate display, power down save

VEDA HCT User Manual

	<p>0: normal</p> <p>1: 90 degrees vertical</p> <p>2: 270 degrees vertical</p> <p>3: Inverted</p> <p>Note: Adaptive adjustment is not possible, you need to adjust the width and height of the window before rotating.</p>
SRW10052	<p>Set the current brightness percentage value 1~100, SRW10052, power down save.</p>
SRW10053	<p>Set current volume percentage value 1~100, SRW10053, power down save.</p>
SRW10055	<p>Time zone setting. Take the value 1~82, corresponding to different time zones, other values (including 0) indicate East 8 (China), the default value is 0.</p>
SRW10056	<p>Enable/disable synchronization of time from NTP server.</p> <p>SRW10056 = 1: synchronization allowed. = 2: Synchronization is disabled. = other values (including 0): not defined.</p>
SRW10057	<p>Configuration change flag. Occupies 1 word, 1 before configuration download, after download, value is 2. Needs to be cleared by user. [floader].</p>

VEDA HCT User Manual

SRW10080	<p>Set the maximum execution time of macro instruction, unit hundred milliseconds, 0 - no limit, 1 - macro instruction execution time (not including the communication time of reading and writing registers) exceeds 100mS, forcibly terminate the macro instruction. The default value is 10 i.e. 1S, power down and save.</p>
SRW10082	<p>Single character, font size setting for Pinyin input method, 12~32 numbers. Power down save</p>
SRW10084	<p>Keyboard arrow keys to move the mouse in steps, unit: pixels</p>
SRW10110	<p>User level 1 password, password can be any combination of 0~9, maximum support 8 numbers. Note that for example 0123 and 00123 are different passwords. Occupies SRW10110~113, 4 characters in total, please use ASCII components to read or display the password value</p>
SRW10114	<p>User level 2 password, password can be any combination of 0 to 9, maximum 8 digits supported. Note that for example 0123 and 00123 are different passwords. Occupies SRW10114~117, 4 words in total, please use ASCII components to read or display the password value</p>
SRW10118	<p>User level 3 password, password can be any combination of 0 to 9, maximum 8 digits supported. Note that for example 0123 and 00123 are different passwords. Occupy</p>

VEDA HCT User Manual

	<p>SRW10118~121, 4 words in total, please use ASCII components to read or display the password value</p>
SRW10122	<p>User level 4 password, password can be any combination of 0 to 9, maximum 8 digits supported. Note that for example 0123 and 00123 are different passwords. Occupy SRW10122~125, 4 characters in total, please use ASCII components to read or display the password value</p>
SRW10126	<p>User level 5 passwords, passwords can be any combination of 0 to 9, maximum 8 digits supported. Note that for example 0123 and 00123 are different passwords. Occupy SRW10126~129, 4 characters in total, please use ASCII components to read or display the password value</p>
SRW10130	<p>User level 6 password, password can be any combination of 0 to 9, maximum 8 digits supported. Note that for example 0123 and 00123 are different passwords. Occupy SRW10130~133, 4 characters in total, please use ASCII components to read or display the password value</p>
SRW10134	<p>User level 7 password, password can be any combination of 0 to 9, maximum 8 digits supported. Note that for example 0123 and 00123 are different passwords. Occupy</p>

VEDA HCT User Manual

	SRW10134~137, 4 characters in total, please use ASCII components to read or display the password value
SRW10138	User level 8 passwords, passwords can be any combination of 0 to 9, maximum 8 digits supported. Note that for example 0123 and 00123 are different passwords. Occupy SRW10138~141, 4 words in total, please use ASCII components to read or display the password value
SRW10142	User level 9 passwords, passwords can be any combination of 0 to 9, maximum 8 digits supported. Note that for example 0123 and 00123 are different passwords. Occupy SRW10142~145, 4 characters in total, please use ASCII components to read or display the password value
SRW10146	User level 10 passwords, passwords can be any combination of 0 to 9, maximum 8 digits supported. Note that for example 0123 and 00123 are different passwords. Occupy SRW10146~149, 4 words in total, please use ASCII component to read or display the password value
SRW10150	User level 11 password, password can be any combination from 0 to 9, maximum 8 digits supported. Note that for example 0123 and 00123 are different passwords. Occupy

VEDA HCT User Manual

	<p>SRW10150~153, 4 words in total, please use ASCII components to read or display the password value</p>
SRW10154	<p>User level 12 password, password can be any combination of 0 to 9, maximum 8 digits supported. Note that for example 0123 and 00123 are different passwords. Occupy</p> <p>SRW10154~157, 4 words in total, please use ASCII components to read or display the password value</p>
SRW10158	<p>User level 13 password, password can be any combination of 0 to 9, maximum 8 digits supported. Note that for example 0123 and 00123 are different passwords. Occupy</p> <p>SRW10158~161, 4 words in total, please use ASCII components to read or display the password value</p>
SRW10162	<p>User level 14 password, password can be any combination of 0 to 9, maximum 8 digits supported. Note that for example 0123 and 00123 are different passwords. Occupy</p> <p>SRW10162~165, 4 characters in total, please use ASCII components to read or display the password value</p>
SRW10166	<p>User level 15 passwords, passwords can be any combination of 0 to 9, maximum 8 digits supported. Note that for example 0123 and 00123 are different passwords. Occupancy</p>

VEDA HCT User Manual

	SRW10166~169, 4 characters in total, please use ASCII components to read or display the password value
SRW10180	VNC control password, password verification has control rights, can be controlled remotely. No password, set to empty
SRW10184	VNC monitoring password, password verification with monitoring rights, only monitoring, not control. No password, set to empty
SRW10199	Occupies one word (16-bit unsigned number), used to set the delay time between HMI start and start of external communication, unit is second, take value 0~300.
SRW10200	SRW10200~201;COM1 communication baud rate setting, occupies a double word (32-bit unsigned number) to indicate: value range: 110~187500. power down to save, restart to take effect.
SRW10202	SRW10202;COM1 communication data bit, occupies one word (16-bit unsigned number) to indicate: 8 - 8 data bits, 7 - 7 data bits, power down to save, restart to take effect.
SRW10203	SRW10203;COM1 communication stop bit, occupies a word (16-bit unsigned number) indicating: 1 - 1 stop bit, 2 - 2 stop bits, power down save, restart effective.

VEDA HCT User Manual

SRW10204	SRW10204;COM1 communication parity bit, occupies one word (16-bit unsigned number) indicating: 0 - no parity, 1 - odd parity, 2 - even parity, power down save, restart effective.
SRW10205	SRW10205;COM1 communication mode, occupies a word (16-bit unsigned number) indicating: 0-232,1-485-4w,2-485-2w, power down save, restart effective.
SRW10210	SRW10210~225;COM1 connected devices by station number shield communication, occupy 16 words, each word 16 bits, corresponding to the station number 0 ~ 255. For example, SRW10211 Bit3 set to 1 represents the serial port connected to the station number 19 of the device shield, no longer communicate. The relevant component data is no longer refreshed. The configuration is saved at power-down and takes effect immediately.
SRW10230	Allow/prohibit COM1 auto-mask communication: SRW10230; occupies a word (16-bit unsigned number) indicating: 10 and above - allows automatic mask communication by station number in case of communication failure; 0 to 9 - prohibits auto-masking.

VEDA HCT User Manual

	<p>The station number to be automatically blocked is viewed via SRW800~SRW815. The retry period after auto-masking is set via SRW10231.</p>
SRW10231	<p>COM1 auto-mask retry cycle: SRW10231; Sets the cycle time, in seconds, for the probe test after entering the auto-mask state. Occupies a word (16-bit unsigned number) to indicate that the default value is 0 for 10 seconds and takes a maximum value of 65535 seconds.</p> <p>This register is valid when SRW10230 is set to allow automatic masking.</p>
SRW10250	<p>SRW10250~251;COM2 communication baud rate setting, occupies a double word (32-bit unsigned number) to indicate: value range: 110~187500. power down to save, restart to take effect.</p>
SRW10252	<p>SRW10252;COM2 communication data bit, occupies one word (16-bit unsigned number) to indicate: 8 - 8 data bits, 7 - 7 data bits, power down to save, restart to take effect.</p>
SRW10253	<p>SRW10253;COM2 communication stop bit, occupies a word (16-bit unsigned number) indicating: 1 - 1 stop bit, 2 - 2 stop bits, power down save, restart effective.</p>
SRW10254	<p>SRW10254;COM2 communication parity bit, occupies one word (16 unsigned digits) and indicates: 0 - no parity, 1 -</p>

VEDA HCT User Manual

	<p>odd parity, 2 - even parity, power down save, restart effective.</p>
SRW10255	<p>SRW10255;COM2 communication mode, occupies a word (16-bit unsigned number) indicating: 0-232,1-485-4w,2-485-2w, power down save, restart effective.</p>
SRW10260	<p>SRW10260~275; COM2 connected devices by station number shield communication, occupy 16 words, each word 16 bits, corresponding to the station number 0 ~ 255. For example, SRW10251 Bit3 set to 1 means that the serial port connected to the station number 19 of the device shield, no longer communicate. The relevant component data is no longer refreshed. The configuration is saved at power-down and takes effect immediately.</p>
SRW10280	<p>Allow/Prohibit COM2 auto-mask communication: SRW10280; occupies a word (16-bit unsigned number) indicating: 10 and above - allows automatic mask communication by station number in case of communication failure; 0 to 9 - prohibits auto-mask.</p> <p>The station number to be automatically blocked is viewed via SRW820~SRW835. The retry period after auto-masking is set via SRW10281.</p>

VEDA HCT User Manual

SRW10281	<p>COM2 auto-mask retry cycle: SRW10281; Sets the cycle time, in seconds, for communication probing after entering the auto-mask state. Occupies a word (16-bit unsigned number) to indicate that the default value is 0 for 10 seconds and takes a maximum value of 65535 seconds.</p> <p>This register is valid when SRW10280 is set to allow auto-masking.</p>
SRW10300	<p>SRW10300~301;COM1 communication baud rate setting, occupies a double word (32-bit unsigned number) to indicate: take the value range: 110~187500. power down to save, restart to take effect.</p>
SRW10302	<p>SRW10302;COM3 communication data bit, occupies a word (16-bit unsigned number) to indicate: 8 - 8 data bits, 7 - 7 data bits, power down to save, restart to take effect.</p>
SRW10303	<p>SRW10303;COM3 communication stop bit, occupies a word (16-bit unsigned number) indicating: 1 - 1 stop bit, 2 - 2 stop bits, power down save, restart effective.</p>
SRW10304	<p>SRW10304;COM3 communication parity bit, occupies one word (16 unsigned digits) and indicates: 0 - no parity, 1 - odd parity, 2 - even parity, power down save, restart effective.</p>

VEDA HCT User Manual

SRW10305	<p>SRW10305;COM3 communication mode, occupies a word (16-bit unsigned number) indicating: 0-232,1-485-4w,2-485-2w, power down save, restart effective.</p>
SRW10310	<p>SRW10310~325; COM3 connected devices by station number shield communication, occupy 16 words, each word 16 bits, corresponding to the station number 0 ~ 255. For example, SRW10311 Bit3 set to 1 represents the serial port connected to the station number 19 of the device shield, no longer communicate. The relevant component data is no longer refreshed. The configuration is saved at power-down and takes effect immediately.</p>
SRW10330	<p>Allow/prohibit COM3 auto-mask communication: SRW10330; occupies a word (16-bit unsigned number) indicating: 10 and above - allow auto-mask communication by station number in case of communication failure; 0 to 9 - prohibit auto-mask.</p> <p>The station number to be automatically blocked is viewed via SRW840~SRW855. The retry period after auto-masking is set via SRW10331.</p>
SRW10331	<p>COM3 auto-mask retry cycle: SRW10331; Sets the cycle time in seconds for communication probing after entering the auto-mask state. Occupies a word (16-bit unsigned number)</p>

VEDA HCT User Manual

	<p>to indicate that the default value is 0 for 10 seconds and takes a maximum value of 65535 seconds.</p> <p>This register is valid when SRW10330 is set to allow auto-masking.</p>
SRW10350	<p>SRW10350~351;COM4 communication baud rate setting, occupies a double word (32-bit unsigned number) to indicate: value range: 110~187500. power down to save, restart to take effect.</p>
SRW10352	<p>SRW10352;COM4 communication data bit, occupies a word (16-bit unsigned number) to indicate: 8 - 8 data bits, 7 - 7 data bits, power down save, restart effective.</p>
SRW10353	<p>SRW10353;COM4 communication stop bit, occupies one word (16-bit unsigned number) and indicates: 1 - 1 stop bit, 2 - 2 stop bits, power down save, restart effective.</p>
SRW10354	<p>SRW10354;COM4 communication parity bit, occupies one word (16 unsigned digits) and indicates: 0 - no parity, 1 - odd parity, 2 - even parity, power down save, restart effective.</p>
SRW10355	<p>SRW10355;COM4 communication mode, occupies a word (16-bit unsigned number) indicating: 0-232,1-485-4w,2-485-2w, power down save, restart effective.</p>

VEDA HCT User Manual

SRW10360	<p>SRW10360~375;COM4 connected devices by station number shield communication, occupy 16 words, each word 16 bits, corresponding to the station number 0 ~ 255. For example, SRW10361 Bit3 set to 1 represents the serial port connected to the station number 19 of the device shield, no longer communicate. The relevant component data is no longer refreshed. The configuration is saved at power down and takes effect immediately.</p>
SRW10380	<p>Allow/prohibit COM4 auto-mask communication: SRW10380; occupies a word (16-bit unsigned number) indicating: 10 and above - allows automatic mask communication by station number in case of communication failure; 0 to 9 - prohibits auto-masking.</p> <p>The station number to be automatically blocked is viewed via SRW860~SRW875. The retry period after auto-masking is set via SRW10381.</p>
SRW10381	<p>COM4 auto-mask retry cycle: SRW10381; Sets the cycle time in seconds for communication probing after entering the auto-mask state. Occupies a word (16-bit unsigned number) to indicate that the default value is 0 for 10 seconds and takes a maximum value of 65535 seconds.</p>

VEDA HCT User Manual

	<p>This register is valid when SRW10380 is set to allow auto-masking.</p>
SRW10500	<p>SRW10500~10515; Network PLC communication mask bit, this mask bit is for IP, if more than one PLC is connected to the same IP at the same time, the communication of all these PLCs is blocked.</p> <p>For example: SRW10500.0 set to 1 to block communication of the first network PLC corresponding to the IP, SRW10500.1 set to 1 to block communication of the second network PLC corresponding to the IP.</p>
SRW10518	<p>Allow/prohibit Ethernet auto-mask communication: SRW10518; occupies a word (16-bit unsigned number) indicating: 10 and above - allow auto-mask communication by IP in case of communication failure; 0 to 9 - prohibit auto-mask.</p> <p>The auto-masked Ethernet devices are viewed via SRW880~SRW895. The retry period after communication is automatically blocked is set via SRW10519.</p>
SRW10519	<p>Ethernet device communication auto-mask retry period: SRW10519; Sets the cycle time in seconds for communication probing after entering the auto-mask state. It is expressed as a word (16-bit unsigned number) and the</p>

VEDA HCT User Manual

	<p>default value is 0 for 10 seconds, taking a maximum value of 65535 seconds.</p> <p>This register is valid when SRW10518 is set to allow automatic masking.</p>
SRW10520	<p>The 15 level passwords for SETUP mode, corresponding to SRW10110~169, occupy 60 words</p>
SRW10590	<p>SRW10590~10593; remote PLC communication blocking bit, used to set whether remote PLC communication is blocked or not, 4 single words up to 63 remote PLCs are blocked, corresponding to position 1 means blocking this remote PLC.</p> <p>For example: SRW10590.1 is set to 1 to block the first remote PLC added, SRW10590.2 is set to 1 to block the second remote PLC added.</p> <p>Note: SRW10590.0 is not valid</p>
SRW10600	<p>SRW10600~10601, user account disable bit, used to set whether the user account is disabled or not, 2 single words can disable up to 32 previous user accounts, corresponding bit setting 1 means disable.</p> <p>For example: SRW10600.0 set to 1 to disable account 1, SRW10600.1 set to 0 to not disable account 2.</p>

VEDA HCT User Manual

SRW10610	<p>SRW10610~10641, user login failure count, 32 words in total, each word indicates the number of failed login attempts for one account.</p> <p>For example, SRW10610 means the number of failed login attempts for account 1, SRW10641 means the number of failed login attempts for account 32.</p>
SRW10700	<p>If 1, it means that the 4G box cannot use GSM and will be disconnected if it is found to be using GSM when connected to the 4G network.</p>
SRW10710	<p>IP address setting for Ethernet 2, power down hold, SRW10710~13, each WORD indicates an IP segment. Static read/write, dynamic read only.</p>
SRW10714	<p>Ethernet 2's Subnet Mask setting, Power Down Hold, SRW10714~17, each WORD represents an IP segment, read/write when static, read-only when dynamic.</p>
SRW10718	<p>Ethernet 2's Gateway setting, Power down hold, SRW10718~21, each WORD represents an IP segment, read/write at static, read-only at dynamic.</p>
SRW10722	<p>DNS1 setting for Ethernet 2, Power down hold, SRW10722~25, each WORD represents an IP segment, read/write at static, read-only at dynamic.</p>

VEDA HCT User Manual

SRW10726	DNS2 setting for Ethernet 2, Power Down Hold, Alternate DNS, SRW10726~29, each WORD represents an IP segment, read/write at static, read-only at dynamic.
SRW10730	LAN IP address setting for Ethernet 2, Power down hold, SRW10730~33, each WORD represents an IP segment. Read and write available when static.