

## Commi ssi oni ng and Mai ntenance Manual

HXT070 cool i ng uni t, SS-Pi pi ng / PVC-C Pi pi ng

Versi on 1.0



## QUICK START-UP GUIDE

THE FOLLOWING STEPS OF THE QUICK START-UP GUIDE MUST BE PERFORMED DURING THE INSTALLATION AND COMMISSIONING.

If any problems occur, contact your local distributor.

1. Check that delivery corresponds to your order.
2. Before starting commissioning, read carefully the safety instructions in Chapter 1 [SAFETY](#).
3. Check that the specified installation location and ambient conditions comply with the specifications. Refer to Chapter 2.3.2, [Required ambient conditions](#).
4. Any customer made piping must be thoroughly flushed before connecting to the HX-unit.
5. Check that the liquid quality is approved. Refer to Chapter 2.3.1, [Liquid quality](#).
6. Connect the mechanical and electrical couplings. Refer to Chapter 3.1.2, [Pipe connections](#) and 3.2 [STEP 2, ELECTRICAL PART](#).
7. Adjust the HX control unit parameters to match the specific project requirements. Refer to Chapter 3.3.2, [Application parameter list](#).
8. Perform a pressure test to the primary circuit and secondary circuit connections. Refer to Chapter 3.1.4, [Pressure test](#).
9. Add coolant to the circuits and de-air them according to the instructions in 3.1.6, [Adding liquid and de-airing](#).
10. Adjust the primary circuit flow and temperature to match the project requirements. Refer to Chapter 3.4.2, [Adjusting the system flow and setting the switch point of the FTSA11](#).
11. Do not energize the main drives before the HX-unit has been running for 30 min without any alarms. Refer to Chapter 3.4.3, [Checklist before starting main NX drives](#).

Vacon Plc is not responsible for the use of its products contrary to these instructions.

## ABOUT THE VACON HX-UNIT MANUAL

The Commissioning and Maintenance Manual provides you with the necessary information about the maintenance and commissioning of a Vacon HX-unit. We recommend that you carefully study these instructions before powering up a Vacon liquid-cooled drive and HX-unit for the first time.

This manual is available both in paper and electronic editions. We recommend you use the electronic version if possible. If you use the electronic version, you benefit from the following features:

- The manual contains several links and cross-references, which make it easier for the reader to move around in the manual, to check and find things faster.
- The manual contains hyperlinks to web pages. To visit these web pages through the links, you must have access to the Internet and have an Internet browser installed in your computer.

**VOCABULARY**

Primary circuit, HXT070-PS01	A closed circuit filled with coolant that connects the drive to the HX-unit.
Secondary circuit, HXT070-P002	A circuit filled with coolant that connects the HX-unit to the customer piping.
HX-unit	HXT070 cooling unit (see the front picture of the manual). The ordering code for the unit on the front page is HXT-M-070-N-P/S, but it is referred to as HXT070 or just plain HX-unit for short.
Drive	Liquid cooled frequency converters or inverters that are connected to the HX-unit.
Main drive	A term used in some contexts for the Vacon NX liquid Cooled converters so that they are more easily separated from the air-cooled Vacon NXP 0009 used in the HX-unit. The main drive concept might also include other liquid cooled electrical equipment.
HX control unit	The air-cooled NXP 0009 drive that is placed inside the HX-unit for the purpose of controlling and monitoring the primary circuit pump and instruments.

## INDEX

<b>1.</b>	<b>SAFETY .....</b>	<b>8</b>
1.1	USE OF SYMBOLS.....	8
1.2	GENERAL WARNINGS AND NOTES WHEN WORKING WITH THE HX-UNIT .....	9
<b>2.</b>	<b>INTRODUCTION.....</b>	<b>10</b>
2.1	ABOUT THIS MANUAL.....	10
2.2	PROCESS AND INSTRUMENTATION.....	11
2.2.1	Primary circuit components and function.....	12
2.2.2	Secondary circuit components and function.....	12
2.2.3	Control unit.....	13
2.2.4	Instruments and their function .....	13
2.2.5	Control / supervision parameters.....	14
2.2.6	HX-unit electrical box.....	15
2.3	INSTALLATION SPECIFICATIONS .....	16
2.3.1	Liquid quality .....	16
2.3.2	Required ambient conditions .....	17
<b>3.</b>	<b>COMMISSIONING.....</b>	<b>18</b>
3.1	STEP 1, MECHANICAL PART .....	18
3.1.1	General installation instructions .....	18
3.1.2	Pipe connections.....	18
3.1.3	Pipe flushing.....	19
3.1.4	Pressure test.....	20
3.1.5	Setting up the primary circuit .....	21
3.1.6	Adding liquid and de-airing .....	22
3.1.7	Adding corrosion inhibitor when using a fresh water system .....	23
3.2	STEP 2, ELECTRICAL PART .....	25
3.2.1	Power supply .....	25
3.2.2	Signal cables .....	25
3.3	STEP 3, CONTROL UNIT SETUP .....	26
3.3.1	Basic setup .....	26
3.3.2	Application parameter list.....	26
3.3.3	Parameter description.....	27
3.3.4	General information about alarms and shutoff limits.....	29
3.3.5	FTSA11 flow switch function .....	29
3.3.6	Temperature set points .....	31
3.3.7	Temperature alarm settings.....	36
3.3.8	Low pressure alarm .....	37
3.3.9	Leak switch alarm specifications .....	37
3.3.10	Three-way valve actuator settings.....	38
3.4	STEP 4, ADJUSTING THE FLOW .....	39
3.4.1	Starting the pump .....	39
3.4.2	Adjusting the system flow and setting the switch point of the FTSA11 .....	40
3.4.3	Checklist before starting main NX drives .....	41
<b>4.</b>	<b>UNIT MAINTENANCE.....</b>	<b>42</b>
4.1	GENERAL MAINTENANCE.....	42
4.1.1	Renewing liquid in the primary circuit .....	42
4.1.2	Maintenance schedule.....	42

---





4.2	MAINTENANCE BY COMPONENT.....	42
4.2.1	Pump.....	42
4.2.2	Heat exchanger .....	44
4.2.3	Pressure vessel .....	46
5.	<b>TROUBLESHOOTING.....</b>	<b>47</b>
5.1	Alarms and shutoffs .....	47
5.1.1	Flow fault .....	47
5.1.2	Temperature alarms and shutoffs.....	49
5.1.3	Low pressure alarm .....	52
5.1.4	Leak alarms .....	53
6.	<b>TECHNICAL SPECIFICATION.....</b>	<b>54</b>

## 1. SAFETY

This chapter contains the general safety instructions, which you must follow when installing, commissioning, operating and maintaining the HX-unit. Read the safety instructions before you start to work on the unit.

### 1.1 USE OF SYMBOLS





For your own safety, please pay special attention to the instructions marked with the following symbols:

 DANGER	Risk of death. Instructions on preventing a possible severe hazard to persons or equipment.
 WARNING	Risk of damage. Instructions on preventing possible damage to equipment.
 HOT SURFACE	Hot surface. Instructions on preventing a possible minor hazard to persons or equipment.
 NOTE	Notification



## 1.2 GENERAL WARNINGS AND NOTES WHEN WORKING WITH THE HX-UNIT

These safety instructions are intended for all who work on the HX-unit. These instructions include only a part of the complete safety instructions. Read the Vacon NX Liquid Cooled User's Manual safety instructions as well. Ignoring the instructions can cause physical injury or death. It can also cause serious malfunctions to the HX-unit that is not covered by the warranty. When working on the HX-unit generally acknowledged safety standards, EU directives and national regulations must also be followed.

 DANGER	1	Only qualified and authorized electricians and mechanics are allowed to carry out the installation and maintenance work on the HX-unit.
	2	Do not open the drive section doors while the drives are online. If you suspect a coolant leak in the drive section, shut down the drives and disconnect the power to them before opening the drive section cubicle doors.
	3	When working with the HX-unit together with the frequency converter, also follow the Vacon NX Liquid Cooled Drive User's Manual safety instructions to prevent any accidents.
	4	Any installation work on the HX-unit must be done with power off. The power must not be reconnected before the installation work is complete.
	5	The primary cooling circuit can contain hot coolant (over +50°C) during normal operation. Serious burns are possible. Before performing maintenance, switch off the unit and allow it to cool down.
	6	The primary cooling circuit can contain high-pressure coolant (6 bar) during operation. Release the pressure in the HX-unit before performing maintenance. Use safety goggles.
 WARNING	7	The HX-unit must be positioned in a non-hazardous area where it can't pose a threat to any main systems or persons.
	8	The coolant consists, depending on the project, of plain drinking water or of a mix of water, propylene glycol and corrosion inhibitors. Glycol and corrosion inhibitors are dangerous to health. If you get coolant mixed with glycol or corrosion inhibitors in your eyes, on your skin, or in your mouth, seek medical advice.
 HOT SURFACE	1	It is the customer's and/or end-user's responsibility to provide flow and temperature control to the secondary circuit. If the project specified flow and temperature for the secondary circuit is not met the warranty is not valid.
	2	Retain these operating instructions during the entire life cycle of the HX-unit.
	3	The HX-unit should always be transported empty (that is, without coolant) to prevent damage caused by low and high ambient temperatures.
	4	Do not allow any force or vibrations to enter the unit through the secondary circuit pipe connections or through the fixing points of the HX-unit. This will shorten the MTBF (mean time between failure) of the HX-unit.
	5	If the HX-unit is purchased without a cubicle, place it inside a cubicle of choice and fix the HX-unit frame to the cubicle frame.
	6	Always install a filter before the HX-unit if the secondary circuit cooling liquid contains particles larger than 2 mm. If the secondary circuit liquid contains chemical or biological residue the MTTM (Mean time to Maintenance) is significantly reduced due to clogging in the plate heat exchanger inside the HX-unit.
 NOTE	1	It is the customer's and/or end-user's responsibility to provide flow and temperature control to the secondary circuit. If the project specified flow and temperature for the secondary circuit is not met the warranty is not valid.
	2	Retain these operating instructions during the entire life cycle of the HX-unit.
	3	The HX-unit should always be transported empty (that is, without coolant) to prevent damage caused by low and high ambient temperatures.
	4	Do not allow any force or vibrations to enter the unit through the secondary circuit pipe connections or through the fixing points of the HX-unit. This will shorten the MTBF (mean time between failure) of the HX-unit.
	5	If the HX-unit is purchased without a cubicle, place it inside a cubicle of choice and fix the HX-unit frame to the cubicle frame.
	6	Always install a filter before the HX-unit if the secondary circuit cooling liquid contains particles larger than 2 mm. If the secondary circuit liquid contains chemical or biological residue the MTTM (Mean time to Maintenance) is significantly reduced due to clogging in the plate heat exchanger inside the HX-unit.

## 2. INTRODUCTION

### 2.1 ABOUT THIS MANUAL

This manual provides information on commissioning and maintenance issues of the HXT070 cooling unit. The manual is intended to be used by Vacon's own personnel as well as the customer and/or end-user.

To follow the instructions in this manual, the reader must have a reasonable knowledge of mechanics and electricians.

	Only a qualified and authorized mechanic is allowed to perform commissioning or maintenance of the HX-unit. A qualified and authorized electrician should accompany the mechanic performing maintenance or commissioning on the unit.
---	---

This manual is divided into following chapters:

**Chapter 1 SAFETY** explains the symbols used in this manual and contains the general safety instructions. Read the safety instructions before continuing.

**Chapter 2 INTRODUCTION** explains how the HX-unit is built by looking into the unit process and instrumentation. The idea is to give the reader a basic understanding of the process and control philosophy. This chapter also includes specifications on correct ambient conditions for the HX-unit.

**Chapter 3 COMMISSIONING** provides information on how to install and how to start-up the unit. The chapter explains, among other things, how the unit is to be filled with liquid and how the system is to be de-aired. The chapter also shows the user the correct valve positions for start-up and how to set up the HX control unit.

**Chapter 4 UNIT SERVICE** explains required maintenance and some repair instructions for the components inside the cooling unit. More unit maintenance instructions can be found in the component maintenance handbooks. They are found at the end of the HX-unit Commissioning and Maintenance folder that is supplied with the unit.

**Chapter 5 TROUBLESHOOTING** includes fault tracing to help the user identify and solve a problem when the HX control unit (air-cooled Vacon NXP 0009) has an active alarm or fault.

**Chapter 6 TECHNICAL SPECIFICATION**

## 2.2 PROCESS AND INSTRUMENTATION

The HX-unit's principle of operation is based on liquid-to-liquid transfer of heat. The primary circuit transports the heat load from the frequency converter to the plate heat exchanger. The secondary circuit liquid flowing through the plate heat exchanger then collects the heat load and transports it to an external condenser. This external condenser (which does not appear on the diagram) is part of the customer and/or end-user's existing cooling system. Another way to dispose of the heat load is to use existing natural resources e.g. a lake or river. The use and choice of a system for disposing of the heat load is the customer's and/or end-user's responsibility.

- Primary circuit, HXT070-PS01 (red colour in the Figure 2.2-1)
- Secondary circuit, HXT070-P002 (blue colour in the Figure 2.2-1)

The FTSA11 flow switch, which monitors the flow in the primary circuit, also includes a temperature sensor. This temperature sensor controls the primary circuit temperature. This sensor sends out an analogue signal to the HX control unit. The control unit application adjusts the primary circuit flow through the plate heat exchanger (HX11) by adjusting the 3-way valve actuator (FV11) to match the temperature setup value for the primary circuit. This temperature setup value is project specific and is adjusted at commissioning. The temperature setup value is dependent on the ambient temperature in the drive cubicle and on the maximum temperature of the customer inlet liquid. The calculation of this value is explained in chapter 3.3.6, [Temperature set points](#).

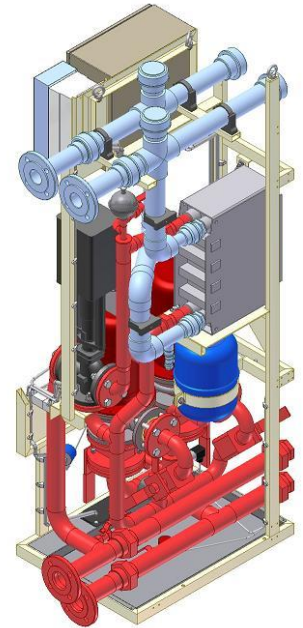

Figure 2.2-1

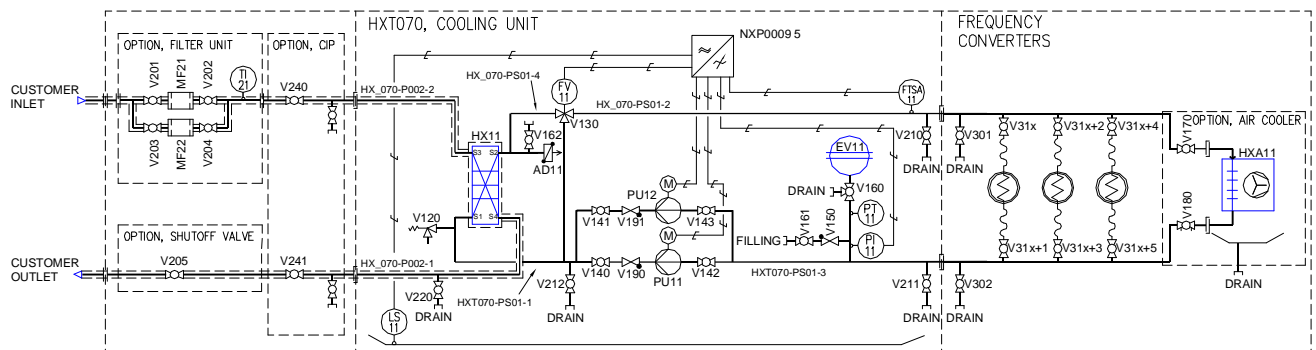

Figure 2.2-2 Piping and instrumentation diagram (P&ID)

A larger P&ID is found in the Commissioning and Maintenance folder that is supplied with the unit.

The HX-unit is equipped with flow, temperature, pressure and leak supervision. The HX control unit application monitors these quantities. The application generates alarms or shut-offs from the instrument's I/O (input/output) signals depending on the parameter settings. The HX control unit interface panel allows the user to access these settings. The settings are found as editable parameters in the HX control unit application. Apart from the leak sensor, LS11, which is placed on the HX-unit floor, all instruments are placed in the primary circuit. Therefore the temperature and flow monitoring in the secondary circuit is the responsibility of the customer and/or end-user.

### 2.2.1 Primary circuit components and function

The primary circuit is a closed circuit with an expansion vessel (EV11, blue part in Figure 2.2-3) that compensates for temperature changes. The primary circuit flow and temperature must match the requirements of the drives that they are connected to. These requirements can be calculated by following the instructions in the Vacon NX Liquid Cooled Drive User's Manual.

As mentioned earlier, the system includes a plate heat exchanger, HX11 (grey colour in Figure 2.2-3). This unit separates the primary circuit from the secondary circuit so therefore it is actually a part of both the primary and the secondary circuits. On the highest position on the primary pipe is the automatic de-airing valve (AD11, violet part in Figure 2.2-3), which removes air from the primary circuit without letting water out.

A 3-way valve V130 (black part in Figure 2.2-3) controls the water temperature through the drives. The valve is regulated by an analogue temperature signal delivered by the flow switch FTSA11. By reducing the flow through the heat exchanger, water temperature through the drives increases, and vice versa.

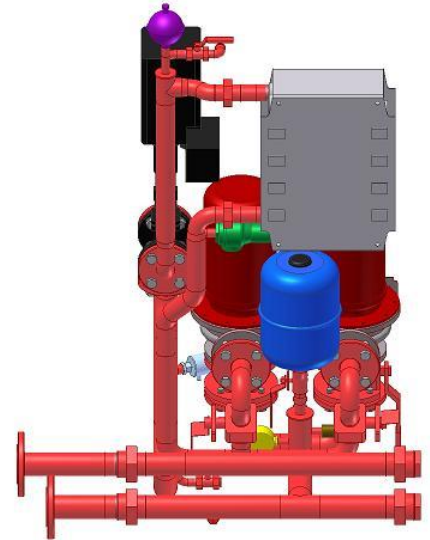

Figure 2.2-3

The default valve regulation set point is +30°C. If the temperature drops below the set point, the 3-way valve starts to reduce the flow through the plate heat exchanger and directs more liquid through the bypass. Keeping the temperature as high as possible in the primary circuit, with regards to the type and load of the main drive, lowers the risk of condensation inside the drive cubicle.

The centrifugal pumps (PU11/12, red parts in Figure 2.2-3) circulate the primary circuit liquid. The pumps are run in sequence, never at the same time. The pumps are as default setup making a sequence switch every 168 hours. The flow can be adjusted to match the need of the connected drives by changing the frequency of the pump motor. The main function of the pump is to deliver enough flow for an optimal liquid-to-liquid heat transfer of the Vacon NX Liquid Cooled series. Other significant parts are the safety valve (V120, green) and the instruments; flow switch (FTSA11, light blue), pressure transmitter (PT11, brown) and the pressure gauge (PI11, yellow). The valves used for maintenance such as filling or de-airing are described in chapter 3.1.6, [Adding liquid and de-airing](#).

### 2.2.2 Secondary circuit components and function

The secondary circuit (Figure 2.2-4) transports the heat load from the primary circuit to a customer-specific object. Through the plate heat exchanger, the heat load from the drives is transferred to the secondary circuit. The HX-unit does not have a control/supervision system for the secondary circuit therefore the customer should use a suitable option to control/supervise the secondary circuit's flow and temperature e.g. flow meter and temperature sensor.

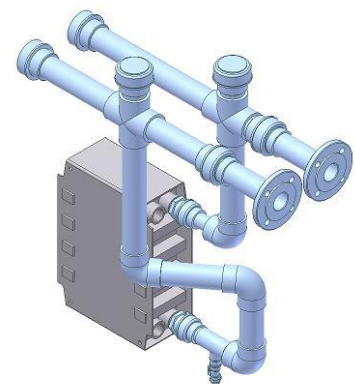

Figure 2.2-4

### 2.2.3 Control unit

The frequency converter, Vacon NXP-series (Figure 2.2-5), works as a control/supervision unit for the primary circuit's temperature and flow, and adjusts the frequency of the cooling pump motor (PU11/12). The frequency converter is programmed to read the I/O signals from the flow switch (FTSA11), pressure sensor (PT11) and leak switch (LS11).

Information on the alarms and how to calculate their limits is found in chapter 3.3 [STEP 3, CONTROL UNIT SETUP](#). Information on how to modify the control unit parameters can be found in the Vacon NXP User's Manual that is supplied with the cooling unit.

The frequency converter includes a Fieldbus link card. By connecting to this card, the customer can view eight different values (parameters), e.g. primary circuit temperatures, pressures, warnings and shutoffs. This is very useful if the HX-unit is not monitored locally. Information regarding the connection type is found in the Vacon NXP User's Manual that is supplied with the HX-unit.

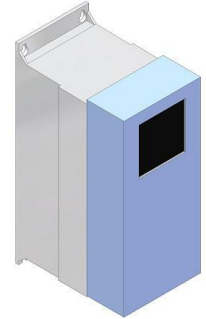

Figure 2.2-5

### 2.2.4 Instruments and their function

The flow switch FTSA11 (Figure 2.2-6) measures the speed of the flow inside the pipe. This flow speed is shown as 0-100% of the measuring range of the instrument. The FTSA11 has two different flow measuring ranges to choose from, 15-150 cm/s or 30-300 cm/s of which the higher range is used in the HX-units. The unit also sends the primary circuit temperature as a 4...20mA signal to the FV11 3-way valve actuator. Both the analogue temperature signal and the 'on/off' switch signal are sent to the HX control unit. The analogue signal is used to control the temperature in the primary circuit and also to generate temperature alarms and shutoffs. The PNP switch output that monitors the flow is used to generate a shutdown command.

The flow speed shown in % on the FTSA11 can easily be modified to flow (l/min) by using the converting formula in chapter 3.4.2, [Adjusting the system flow and setting the switch point of the FTSA11](#). Note that this converting formula is correct only when using the FTSA11 high measuring range (30-300 cm/s) and the original pipe inner diameter.

This flow meter (SW600H-RSB-S4/T) is suitable for concentration of maximum 25% glycol (75% water). If there is more glycol than 25%, a different type of flow meter must be used (e.g. Uniflow SW600K-RSB-S4/T).



Figure 2.2-6

The other instruments found on the HX-unit are a pressure transmitter (PT11) and a pressure gauge (PI11). The pressure transmitter sends a 4...20mA signal to the HX control unit. The control unit application then converts this signal into pressure (bar). This pressure input is then used for monitoring the pump inlet pressure. The idea is to give the user an early warning in case there is a leak in the primary circuit somewhere outside of the HX-unit. The pressure gauge is used when filling the primary circuit with liquid or when performing a pressure test on the unit. It can also be used to get a pressure reference value if the pressure transmitter is thought to be malfunctioning.

### 2.2.5 Control / supervision parameters

When the HX-unit is working within the pre-set limits, it sends a 'cooling OK' signal to the main drives. The HX-unit supervision system is programmed to generate alarms to alert the user to a malfunction in the unit. If the malfunction is more severe, the control unit removes the 'cooling OK' signal to the main drive and takes them offline.

The project-specific minimum flow speed is to be set as switching point for the flow switch FTSA11. The flow switch sends a digital signal to the HX control unit, if the flow speed drops under the preset parameter values. If the signal is active longer than 5 seconds, the HX control unit disconnects the 'cooling OK' signal to the drives. This fault (fault number F87) also stops the HX-unit pumps.

The flow switch FTSA11 also sends out a temperature signal that controls the 3-way valve in the primary circuit. The FTSA11 sends out a 4...20mA signal, which is then sent to the actuator (FV11) on valve V130.

The temperature parameters are adjusted at commissioning, depending on the maximum temperature of the inlet secondary circuit liquid and the ambient temperature in the main drive area. If the temperature drops below the set point in the primary circuit, the valve decreases the amount of liquid going through the plate heat exchanger (HX11) in order to increase the temperature in the primary circuit.

The temperature signal from FTSA11 also generates low- and high-temperature alarms and high-temperature shutoff. The high-temperature alarm and shutoff functions protect the main drives from overheating, and the low temperature alarm protects the main drives from condensation.

If the temperature goes above the high-temperature shutoff limit, the 'cooling OK' signal to the drive is disconnected. In this case, the HX-unit cooling pump continues running, but the main drive is shut down, that is, the 'cooling OK' signal to the drive is disconnected. The default setting for this parameter is 45°C.

The leak switch's sensor (LS11) is located on the leakage plate at the bottom of the HX-unit. The function of the switch is to give a signal to the HX control unit, in case there is liquid on the leakage plate. The liquid can be from a leak in one of the circuits, or from condensation on colder pipe surfaces due to high relative humidity of the air.



NOTE

The HX-unit provides no control of the temperature or flow in the secondary circuit. It is strongly recommended that the customer and/or end-user add a temperature and flow control on the secondary circuit piping outside the HX-unit.

Depending on the quality of the secondary circuit liquid, the plate heat exchanger might clog and affect the efficiency and flow of the unit. Because the primary circuit is a closed circuit, it contains only a small amount of liquid. This means that it will react fast to changes in temperature or flow in the secondary piping.



NOTE

If the flow for some reason is shut down in the secondary circuit, the HX-unit will disconnect the 'cooling OK' signal to the drive within seconds, depending on the main drive load, due to a high-temperature shutoff.

If there is no monitoring equipment in the secondary circuit, it is harder to determine the reason for a possible alarm from the HX-unit. Secondary circuit flow (or pressure difference) and temperature monitoring might in some cases help to prevent an unexpected shutdown of the drive.

### 2.2.6 HX-unit electrical box

The electrical box inside the HX-unit consists of a motor protection relay, circuit breakers, contactors, 400/24 V DC power supply and a terminal.

There are four switches attached to the electrical box door; main power switch, two pump power switches and leak sensor reset switch.

- Main power switch (red/yellow in Figure 2.2-7) is connected to the motor protection relay. Positions "0" (zero) and "1". The contact breaker controls the main power to the HX-unit, including the HX control unit.
- Pump power switch (black and red in Figure 2.2-7), positions "0" (zero) and "1". The contact breaker controls the power to the HX-unit pumps (PU11 and PU12). The pump can be started by turning the switch to position "1", and stopped by turning it back to position "0". If both switches are in position "1" then the pumps are automatically working in sequence, changing every 168 hours (or acc. to project specific value).
- LS11 leak sensor reset switch (white in Figure 2.2-7) resets the leak alarm. To reset the alarm, the liquid must first be removed from the sensor on the HX-unit leakage plate.

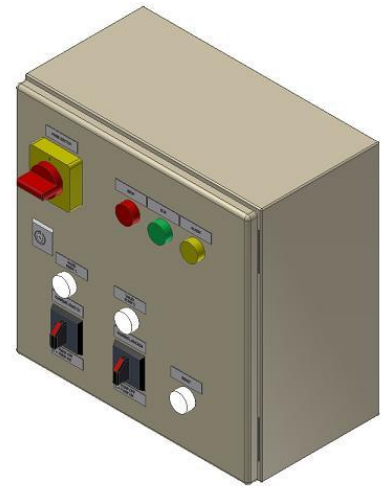

Figure 2.2-7

There are also five indication lights on the electrical box door. The colours indicate the following:

- Red indicates that the HX-unit is not working within correct parameter values. Either the temperature has reached the high-temperature shutoff limit or the flow is too low in the primary circuit. This light also indicates that the 'cooling OK' signal to the main drives is disconnected, therefore the main drives are offline.
- Yellow indicates that there is an active alarm in the HX-unit, meaning that the HX-unit is working outside the optimal temperature and/or pressure range or that there is a leak inside the unit.
- Green indicates that the 'cooling OK' signal to the main drives is connected.
- White indicators show which of the HX-pumps are activated during operation.

The troubleshooting guide is found in chapter [5 TROUBLESHOOTING](#). If the yellow or red indicator is active then you can find more information by accessing the HX control box interface panel. Information on how work the panel is found in the Vacon NXP User's Manual that is supplied with the unit.

## 2.3 INSTALLATION SPECIFICATIONS

### 2.3.1 *Liquid quality*

In the primary circuit, the quality of the liquid has to be as presented in Table 2.3-1, Liquid quality. The liquid should not contain organic sediment or chemically active qualities. The liquid can be treated with corrosion inhibitors suitable for AISI pipes, PTFE and Tesnit BA-S seals. When adding liquid to the primary circuit it is recommended that a filter be used so that no particles larger than 0.3 mm can enter the primary circuit.

The temperature of the liquid going to the main drives must never be lower than the ambient temperature in the cabinet at the point of a start-up of the main drives. If the system is shut down during a cold period and the liquid runs a risk of freezing, a maximum of 20% of glycol can be added to the primary circuit system. If more glycol than 20% is needed to keep the liquid from freezing then contact your local distributor for additional information regarding a load reduction for the main drive.

To prevent corrosion, add the corrosion inhibitor Cortec VpCI-649 to the primary circuit liquid. Use the additive according to the product specification found in the Component Specifications and Maintenance Instructions section of the Commissioning and Maintenance folder.

Primary circuit liquid quality	Unit	Value
pH		6...8
Hardness of liquid	°dH	< 10
Conductivity	µS/cm	< 10
Chlorine, Cl	mg/l	< 10
Iron, Fe	mg/l	< 0,1
Maximum particle size	µm	< 300

Table 2.3-1, *Liquid quality*

The secondary circuit liquid quality is not expected to be as clean as the primary circuit liquid bearing in mind that clean liquid will prolong the time between cleaning the plate heat exchanger (HX11). If the customer and/or end-user are using a natural source of water for the secondary circuit, one can assume that the water will include some kind of organic sediment. This organic sediment will attach itself to the plates inside the HX11 and therefore the liquid-to-liquid heat transfer between the primary circuit and the secondary circuit will, over time, be less efficient. Another problem with this organic sediment is that the pressure loss over the HX11 will also increase and therefore the flow will decrease, which will also lead to poor liquid-to-liquid heat transfer between the primary and secondary circuit.

Because of possible organic sediment in the liquid circulation, it is strongly recommended that flow measuring equipment or a pressure difference measurement be installed on the secondary circuit. This equipment should generate an alarm if the flow is below requirements. When there is a need to clean the heat exchanger, refer to the Alfa Laval, AlfaCaus, Heat Exchanger Cleaning material found in the Component Specifications and Maintenance Instructions section of the Commissioning and Maintenance folder.

In the secondary circuit, the liquid should not contain particles larger than 2 mm. If there are larger particles in the liquid circulation, the heat exchanger might clog within a short period of time. Therefore it is strongly recommended that a filter (MF21) be installed at the secondary circuit inlet, which will filter out particles larger than 2 mm. For more information regarding this filter unit please contact our local distributor.



The secondary circuit liquid should not include any chemical residue that might be harmful for the material used in the HX-unit e.g. high amounts of chlorine, oil etc. The HX-unit with the PVC-C pipes uses EPDM rubber seals that will deteriorate if they come in contact with oil.

### 2.3.2 *Required ambient conditions*

The HX-unit must always be installed to a cubicle. The HX-unit is designed to work within ambient temperatures between +5...+50°C. It is the customer and/or end-user's responsibility to ensure that the temperature remains within this limit during operation. The HX-unit is not built to withstand rain, sand- or snowstorms. If the HX-unit is positioned outside it must be equipped with temperature and humidity control.

There is no condensation allowed in the main drive. As the primary circuit piping is located inside the same cubicle as the main drive it is vital that the primary circuit water temperature doesn't go below the dew-point temperature. The primary circuit temperature is set accordingly to ambient temperature and relative humidity. The most secure way of preventing condensation inside the main drives is to keep the water temperature in the primary circuit higher than the ambient temperature.

If the temperature in the drive room is higher than the temperature of the liquid in the primary circuit piping it can, depending on the relative humidity of the air, cause condensation on the piping as well as inside the drive.

A dew-point chart can be used to optimize the primary circuit minimum temperature. It is recommended that the primary circuit temperature is higher than the ambient temperature but in some cases this will cause an unnecessary reduction of load in the main drive. If this is the case the maximum relative humidity (RH) at the installation must be specified. When the maximum RH and the maximum ambient temperature have been determined, the Dew-Point Chart found in chapter [3.3.6, Temperature set points](#) can be used to define the minimum primary circuit temperature.

### 3. COMMISSIONING

#### 3.1 STEP 1, MECHANICAL PART



Only qualified and authorized mechanics are allowed to perform mechanical work on the HX-unit.

##### 3.1.1 General installation instructions

The HX-unit can be delivered pre-fitted to a VEDA or Rittal cubicle. The HX-unit can also be delivered without cubicle (shown in Figure 3.1-1.), but then the customer must place the HX-unit in the cubicle of their choice. The unit is designed to fit inside a VEDA or Rittal 800x600x2000 mm (W x D x H) cubicle. If the customer and/or end-user are using another kind of cubicle it is their responsibility to ensure that the HX-unit fits inside the cubicle of choice.

If the customer positions the HX-unit in their own cubicle, it is the customer's and/or end-user's responsibility to make sure that the unit is fixed according to requirements. The HX-unit should be fixed to the cubicle frame with suitable and robust supports to prevent the unit from moving or being damaged by vibrations.

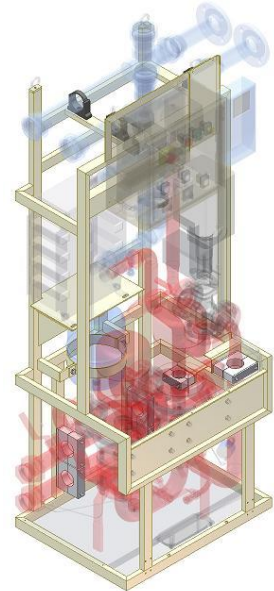

Figure 3.1-1



HX-unit must always be installed to a cubicle VEDA, Rittal or customer's own choice.

##### 3.1.2 Pipe connections

Standard connections are DN50 flanges according to DIN2642. Flange adapters are delivered in a separate box. When placing the HX-unit inside a cubicle it might be necessary to remove also the 2" connector parts that are screwed on to the pipes on the primary connections. This is because the total width is about 751 mm when the connectors are on, and the width (door opening) on e.g. Rittals' 800 mm cubicle is 712 mm.

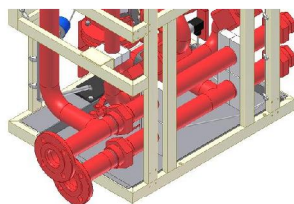
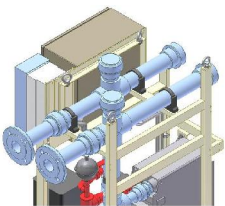
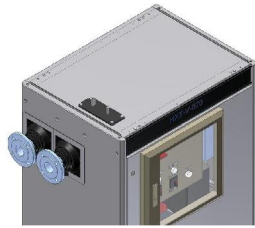

Figure 3.1-2

Figure 3.1-3



The material of the primary circuit and secondary circuit flanges is AISI 316.

The wall penetration is made according to IP54 requirements.

Figure 3.1-4

Figure 3.1-5

If the HX-unit isn't placed in the same line-up as the drives, therefore creating piping between the HX-unit and the main drives, the pressure loss of the piping between the HX-unit and the drive must not exceed 0.7 bar. If the calculated pressure loss is higher than 0.7 bar then the HX-unit will not be able to produce the maximum flow of 200 l/min that is specified for the HXT070.

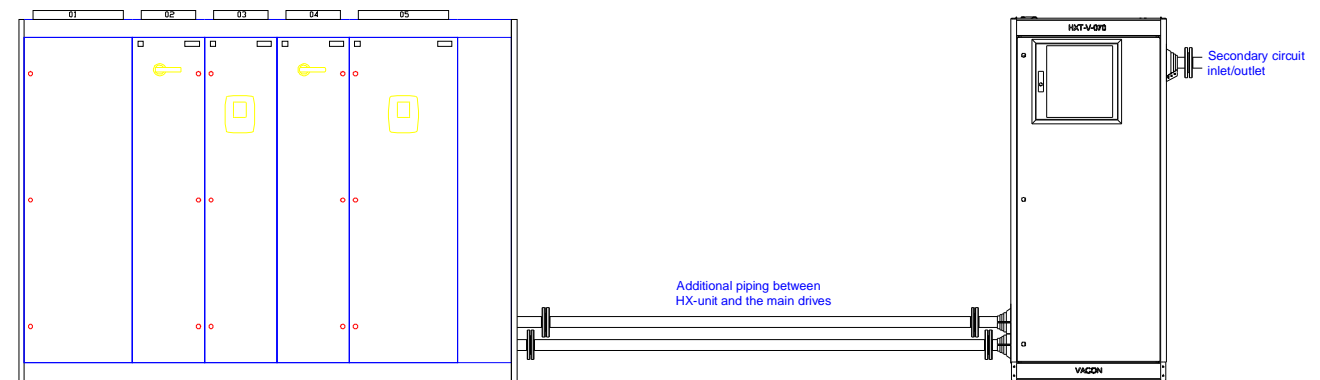

Figure 3.1-6

If the HX-unit is delivered as a part of NX Liquid Cooled switchgear, therefore being in the same line-up, then the connections between the HX-unit and the drive are ready and the customer only needs to connect the secondary circuit piping.

### 3.1.3 Pipe flushing

All piping in the primary or secondary system made by the customer and/or end-user must be flushed before being connected to the HX-unit. If the pipes have been welded with a TIG, it is sufficient to clean the pipes by blowing pressurized air through them. If the welding has been done by other means the pipes have to be thoroughly flushed with water at a minimum of 3 m/s for 5 minutes.

3.1.4 **Pressure test**

A pressure test has already been performed on the HX-unit before delivery but because some of the connections are made on site, additional pressure testing is required. The pressure test performed on site should be done according to EU-directives or national regulations, whichever has priority on site.

 NOTE	The safety valve V120 (marked green in Figure 2.2-3) in the primary circuit is set to 6 bar and has to be removed during the pressure test. The V120 valve connection must be plugged during this pressure test. During the pressure test the de-airing valve AD11 (Figure 3.1-7) has to be closed. The threaded top plug must be replaced with tight plug or add an extra seal under the top plug. After the test change back the originally plug, tighten to end and then open 360 degrees.
---	--

To ensure that every site connection is sufficiently tightened, it is recommended that a pressure test be performed for the primary circuit using pressurized air. The pressurized air can be added through the liquid filling point of the unit, e.g. at valve V161 in the primary circuit.

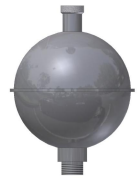



Figure 3.1-7

 DANGER	When performing a pressure test on the HX-unit, generally acknowledged safety standards, EU directives and national regulations must also be followed. <b>Use safety goggles.</b>
--	---

Unless national regulations say otherwise the pressure during the pressure test should be 1.5 times the maximum work pressure.

The maximum pressures are as follows:

Primary circuit AISI 304 piping = 6 bar, therefore the test pressure is 9 bar

Secondary circuit PVC-C piping = 10 bar, therefore the maximum test pressure is 15 bar

If the customer only uses a PN6 piping system on the secondary circuit, the pressure test can be done with pressurized air to 9 bar.

 DANGER	If the secondary circuit is pressure tested higher than 10 bar the test must be done with water. Compressed air should not be used at pressures over 10 bar due to the risk of high-speed debris at a compressed pipe failure.
---	--

 WARNING	The pressures mentioned here are only valid for the HX-unit. The customer and/or end-user are responsible for all other piping made to either the primary or secondary circuit. If the customer and/or end-user make any changes to the piping on the HX-unit they are responsible for them.
--	--

The pressure in the primary circuit can be monitored from the pressure indicator PI11 during the pressure test. If the pressure remains constant for 15 minutes, the system is airtight. If the pressure is decreasing, look for the leak by soaking the pipe connections with soap-liquid. When the leak is located tighten the connection and redo the pressure test.

If the pressure test is done with water the leaks can be located visually, therefore no soap-water is necessary.

### 3.1.5 Setting up the primary circuit

Before filling the system with liquid, check that all pipes and hoses are connected. The maintenance valves V160...V162 are plugged so that no accidents can occur during operation. During maintenance these plugs must be replaced with hose nipples or similar parts so that a hose can be connected to the valve.

The valve handle positions before pre-filling the system are as following:

- Valves V161...V162 open (violet colour in Figure 3.1-8)
- Valve V160 lever down (brown colour in Figure 3.1-8)
- Valves V140...V141 closed (yellow colour in Figure 3.1-8)
- Valves V142...V143 open (orange colour in Figure 3.1-8)
- Valves V210...V212 closed (green colour in Figure 3.1-8)
- Valves V301...V302 closed (see P&ID, Figure 2.2-2)
- Valves V310...V31x open (see P&ID, Figure 2.2-2)

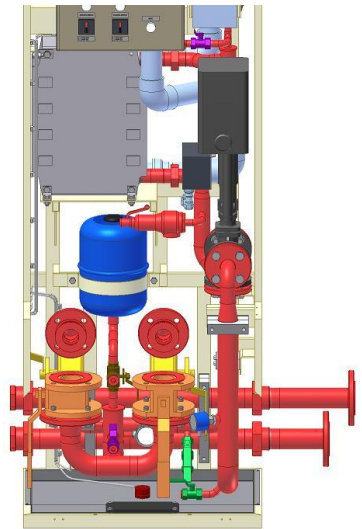

Figure 3.1-8

A hose must be connected to the manual de-airing valve, V162 that is positioned on the highest position on the primary pipe. The other end of this hose should be pointed into a drain or into a tank depending on which system is used for the filling procedure. The system used for filling should be able to produce at least 2 bar and delivery at least 15 l/min.

There are many ways of adding water to a piping system like the primary circuit. The two most common ways of filling are presented next. Which of these are used depend on if the site has a fresh water system or if the water has to be filled from a tank.

Figure 3.1-9 shows how to connect the hoses to the HX-unit if there is no pressurized fresh-water system at hand.

- Connect a suction pump outlet to the filling valve V161. Secure the connections with a hose clamp.
- Connect the drain hose to the manual de-airing valve V162 and put the other end of the hose in the barrel. Secure the connection with a hose clamp.
- Secure the drain hose to the barrel so it won't jump out during the filling and de-airing.
- If corrosion inhibitors are used they can be mixed, in the right amount, with the water in the barrel.
- Depending on the system size there has to be 20-200 litres of liquid in the barrel.

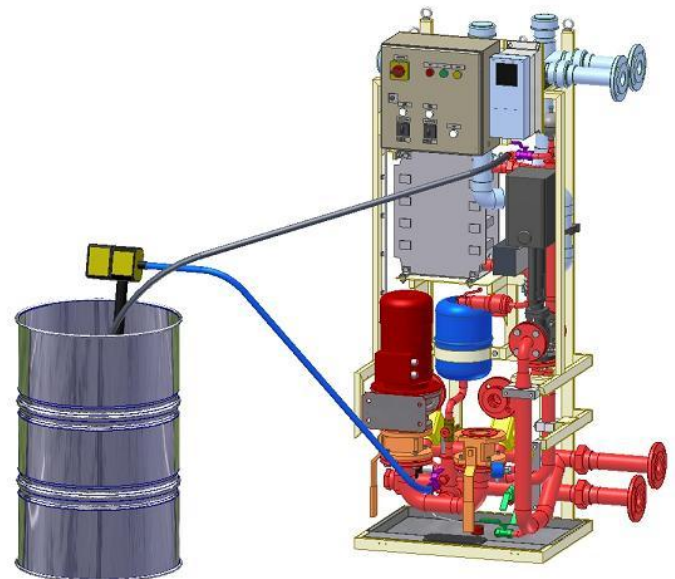

Figure 3.1-9

Figure 3.1-10 shows how to connect the hoses to the HX-unit if there is a pressurized fresh-water system at hand.

- Connect the hose from the faucet to the filling valve V161. Secure the connections with a hose clamp.
- Connect the drain hose to the manual de-airing valve V162 and put the other end of the hose into a drain. Secure the connection with a hose clamp.
- Secure the drain hose to the drain so it won't jump out during the filling and de-airing.
- For adding corrosion inhibitor read [chapter 3.1.7](#).

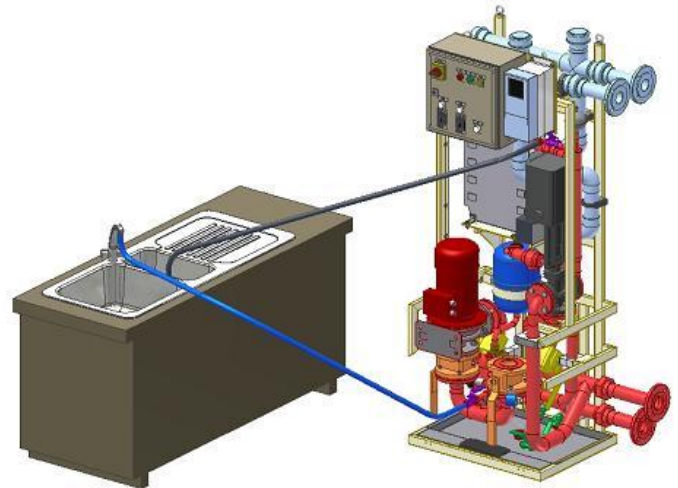

Figure 3.1-10

If a local sink or floor-drain is used and corrosion inhibitors are added to the liquid in the primary circuit then it is the customer and/or end-user's responsibility to check that the coolant mix can be disposed of through the local sewer system.

### 3.1.6 Adding liquid and de-airing

Follow the instructions for the pre-filling process before starting the pump at commissioning or after maintenance.

How to fill the primary circuit HXT070-PS01 (See P&ID in Figure 2.2-2):

1. Prepare the unit according to the recommendations in chapter [3.1.5 Setting up the primary circuit](#). Use valve V161 to regulate the flow during the filling and de-airing of the unit.
2. It is recommended that the flow, from the external pump or water supply system, is low in the beginning of the filling process. This ensures that a minimum amount of air pockets is left in the piping.
3. Close valve V161. Open the faucet or start the external pump depending on which filling system you are using. Slowly open valve V161 to a 30-50% of maximum.
4. After a short while liquid starts to come out of the drain-hose (connected to the valve V162). During the first minutes you will hear a rattling sound in the pipes. This is the air transported out of the system by the water. After the rattling sound stops you should open the filling valve V161 to 100%.
5. Keep the water flowing until you can't hear any more rattles, and then close the V161 valve. Also close all the main drive valves, V310...V3xx, both the inlet and the outlet valves.

Now it is time to de-air the drives. De-air the main drives one hose pair at a time, for example V310 and V311 (See Figure 2.2-2):

6. Open valve V310 first then valve V311, this means that this path will be the only way for the water to pass when you continue filling. Then open the filling valve V161. The water will again come out from the hose connected to the manual de-airing valve V162. Keep the water running until the rattling sound disappears, that is to say the air has been removed after which the V161 filling valve is closed again.
7. Close the valve V310 first, and then the valve V311. This procedure will leave the specific drive section filled with water.



If the external water system used for the filling can produce more than 6 bars there is a risk of the safety valve (V120) opening. This might cause unnecessary problems if some particles are left on the sealing surface of the safety valve and therefore causing a leak. If this happens the safety valve must be cleaned.

8. Repeat this procedure until every frequency converter/inverter is de-aired, that is, open the valve V312 and V313 next and so on.
9. After all the main drive hoses have been de-aired and closed, open valve V140...V141 and then open the filling valve V161. After no more rattling can be heard due to air in the system, close valve V162, the manual de-airing valve.
10. When valve V162 is closed the pressure (see at the PI11, pressure indicator) will start to rise in the primary system. When the pressure in the primary system has raised to two (2) bar close the V161 filling-valve. If you are using an external pump for adding the water it can now be turned off.
11. Keep the two (2) bar pressure for about 10 minutes, letting the air bubbles in the system rise up to the HX11 heat exchanger. Then open the manual de-airing valve V162 to let the pressure back down to 1.5 bar. Close valve V162.
12. Now the system is almost completely de-aired. After this the pumps must be run for short periods to get the rest of the air out from the HX-unit. Refer to chapter [3.4.1 Starting the pump](#) for the rest of the de-airing instructions.

The pre-pressure in the primary circuit should be set to 1.5 bar. During operation the pre-pressure should be between 1.0 to 1.5 bar. If the pre-pressure is reduced to below 1.0 bar during operation liquid must be added. The HX control unit will generate a 'Low-pressure' alarm if the pre-pressure is below 0.5 bar.

### 3.1.7 *Adding corrosion inhibitor when using a fresh water system*

If you are using a fresh water system to add water it is more difficult to add the corrosion inhibitor. The corrosion inhibitor can be added through the manual de-airing valve V162. To do this the water level has to be lowered in the HX11 and a funnel has to be used (Figure 3.1-11).

1. The corrosion inhibitor should be added after all the main drives have been de-aired. Check that all the main drive valves, V310...V3xx, are closed.
2. Lower the liquid level in the plate heat exchanger HX11 by opening the valve V301 (or V210) and letting out 2 litres of water. This will lower the level inside the HX11 and make the necessary space for the corrosion inhibitor.
3. Remove the hose from the valve V162 and replace it with a one (1) meter long hose. Connect a funnel to the loose end of the hose.
4. Keep the funnel higher up than the heat exchanger HX11, and pour the corrosion inhibitor into the HX11 using a jug. Refer to the Cortec VpCI-649 product description for calculating the right amount of corrosion inhibitor (refer to the technical specifications for Cortec found in the Commissioning and Maintenance folder).

5. After all the corrosion inhibitor is added use the same jug to fill the HX11 all the way up with water. When no more water will go into the HX11 then close the manual de-airing valve V162 and remove the hose.
6. Now open the filling valve V161 and increase the pressure back to 1.5 bar. The corrosion inhibitor will get mixed when the pump is rotated for a while.

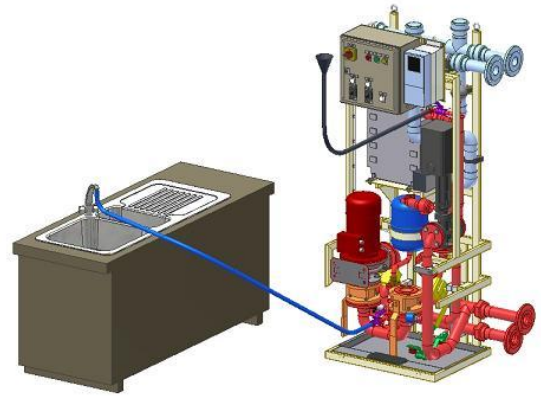

*Figure 3.1-11*



### 3.2 STEP 2, ELECTRICAL PART



Only qualified and authorized electricians are allowed to perform electrical work on the HX-unit.

#### 3.2.1 Power supply

The HX-unit uses 3 ~, 400 VAC (50Hz) or 3 ~, 440 VAC (60Hz), 16 A power supply. There are two alternatives to bring the supply cables to HX-unit: from under or from above (Figure 3.2-1, Figure 3.2-2).

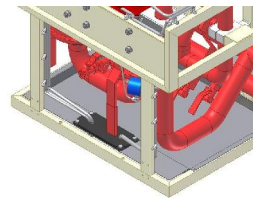

Figure 3.2-1

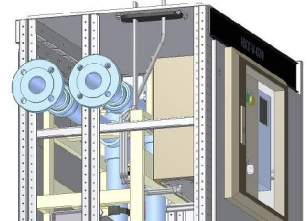

Figure 3.2-2

Connect the power supply to the motor protection relay (marked green in Figure 3.2-3) in the HX-unit electrical box.

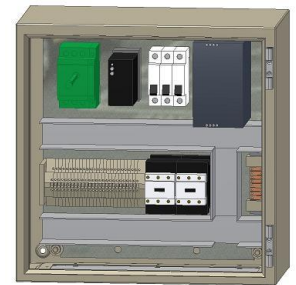

Figure 3.2-3

#### 3.2.2 Signal cables

A signal cable must be connected between the main drive and the HX-unit electrical box. It should be connected from the main drive basic I/O board NXOPTA1, terminal number 6 or 12 (24V out) to the HX-unit X1 terminal block (marked green in Figure 3.2-4) terminal number 16 (cooling OK in), and back from X1, terminal number 17 (cooling OK out) to the main drive, terminal number 14 (DI 4). For more information refer to the project specific electrical diagram and to the Vacon NX Liquid Cooled drive User's Manual that is supplied with the main drives.

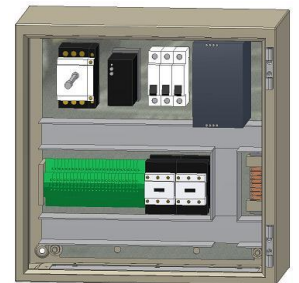

Figure 3.2-4

A 24V auxiliary voltage from the main drive is sent through the cable to the HX-unit. If the HX-unit is working within the preset parameters then the signal is rerouted back to the main drive. When the signal is active in the main drive basic I/O board NXOPTA1 (terminal number 14), then the main drive application will activate a 'Cooling OK' function that will allow starting and operating the main drive (= "Run Enable").

When a flow fault or high temperature fault is active in the HX-unit, the digital output ("cooling OK") contact in the HX control unit will disconnect the 24V signal and the main drives will shut down. The main drive cannot be brought online before the flow fault or high temperature fault is removed.

### 3.3 STEP 3, CONTROL UNIT SETUP

#### 3.3.1 Basic setup

The control unit application includes 'Flow control' parameters that have to be modified for every project. Primary circuit inlet temperature and primary circuit flow are two equally important quantities that have to be monitored at all times. How to calculate the optimum flow is found in chapter [3.4.2, Adjusting the system flow and setting the switch point of the FTSA11](#). How to correctly set up temperature alarms and shutoffs is found in chapter [3.3.6, Temperature set points](#).

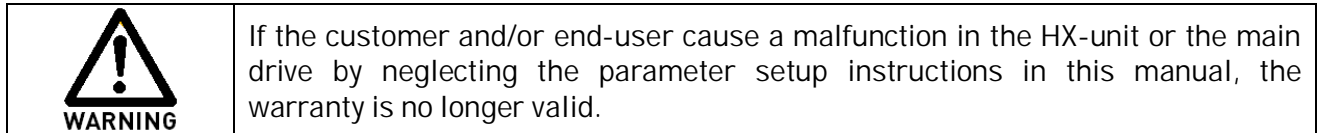

To modify the 'Flow control' parameters one has to be able to use the NXP control panel. Information on how to operate the NXP control panel is found in the Vacon NX Liquid Cooled User's Manual that is supplied with the HX-unit.

The control unit also includes a Fieldbus uplink card (Profibus). The customer can use this uplink to get any of the Vacon NXP parameter values linked to a 'higher' control system. By using this uplink the customer can monitor the HX-unit from an external interface at a chosen location. More information regarding this uplink interface is found in the Vacon NX Liquid Cooled User's Manual that is supplied with the HX-unit.

#### 3.3.2 Application parameter list

The application parameters and their default values are shown in table 3.3-1. The project specific parameters are calculated using the rules found in [chapters 3.3.6 to 3.3.7](#). The values that are used when setting up the HX-unit during commissioning should be written down in the 'Custom, settings' column. If the values must be changed at a later time the new value should be written in the last column (Changes, customer). The parameters that must be edited at commissioning are marked with a \*) in the table 3.3-1. More information about these parameters is found in chapter [3.3.3, Parameter description](#).

### 3.3.3 Parameter description

The table 3.3-1 includes parameters made to monitor and control the HX-unit. This chapter includes short explanations on what the different parameters are used for.

**P2.10.1** is the actual frequency that the pump motor will run at when producing the required flow in the system. The speed of the pump frequency should be optimized according to the required flow (see Chapter 3.4.2, [Adjusting the system flow and setting the switch point of the FTSA11](#)). This will reduce the wear of the cooling system and therefore extend the MTBF (mean time before failure) of the HXT unit and the main drives.

Parameter code	Parameter description	Default setting	Custom, settings	Changes (Customer)
P2.10.1 *)	Frequency to PU11 when PID enabled	50Hz		
P2.10.2	PT11 pressure transmitter low pressure setting, scaling	0 bar		
P2.10.3	PT11 pressure transmitter high pressure setting, scaling	10 bar		
P2.10.4	PT11 pressure error, low pressure alarm	0.5 bar		
P2.10.5	Inlet pressure supervision	1		
P2.10.6	FTSA11 temperature transmitter low temperature setting, scaling	0 °C		
P2.10.7	FTSA11 temperature transmitter high temperature setting, scaling	100 °C		
P2.10.8 *)	FTSA11 temperature error, low temperature alarm	22 °C		
P2.10.9 *)	FTSA11 temperature error, high temperature alarm	28 °C		
P2.10.10 *)	FTSA11 temperature error, high temperature shutoff	35 °C		
P2.10.11	Pump automatic changing sequence time	169 h		
P2.10.12	Fault delay setting	5 s		
P2.11.1	Fieldbus outlet 1	1501		
P2.11.2	Fieldbus outlet 2	2		
P2.11.3	Fieldbus outlet 3	45		
P2.11.4	Fieldbus outlet 4	1511		
P2.11.5	Fieldbus outlet 5	1		
P2.11.6	Fieldbus outlet 6	4		
P2.11.7	Fieldbus outlet 7	5		
P2.11.8	Fieldbus outlet 7	37		
P3.5 *)	FV11 reference temperature	25		

Table 3.3-1, Parameter list

**P2.10.2** is the min. value of the range of the pressure transmitter PT11. It is used to scale the pressure transmitter (PT11) low pressure point. The PT11 has a min measure point at 0 bar.

**P2.10.3** is the max. value of the range of the pressure transmitter PT11. It is used to scale the pressure transmitter (PT11) high pressure point. The PT11 has a max measure point at 10 bar.

**P2.10.4** is a PT11 low temperature, alarm limit. The default setting for this is set at 0.5 bar. More information can be found in chapter [3.3.8, Low-pressure alarm](#).

**P2.10.5** is a selection parameter that should be set to 1. If the PT11 pressure transmitter malfunctions the parameter can be set to 0 therefore overriding the pump suction side pressure supervision. The pressure transmitter **MUST BE REPLACED** as soon as possible, the warranty is not valid if this parameter is set to "0".

**P2.10.6** is the min. value of the range of the temperature transmitter FTSA11. It is used to scale the temperature transmitter (FTSA11) low-temperature point. The FTSA11 has a min measure point at 0°C.

**P2.10.7** is the max. value of the range of the temperature transmitter FTSA11. It is used to scale the temperature transmitter (FTSA11) high-temperature point. The FTSA11 has a max measure point at 100°C.

**P2.10.8** is a FTSA11 low-temperature, alarm limit. The default setting for this is set at 22°C. More information can be found in chapter [3.3.7, Temperature alarm settings](#).

**P2.10.9** is a FTSA11 high-temperature, alarm limit. The default setting for this is set at 28°C. More information can be found in chapter [3.3.7, Temperature alarm settings](#).

**P2.10.10** is a FTSA11 high-temperature, trip limit. The default setting for this is set at 35°C. This means that the drive will shut down ('cooling OK' signal going to the main drives will be disconnected) when the temperature is over 35°C. The HXT unit will stay online (pump running). More information can be found in chapter [3.3.7, Temperature alarm settings](#).

**P2.10.11** the default setting is 169 'hours'. If the setting is between 1-168 (hour) the system will try to change the pumps according to the time setting. This is to be used **ONLY** when operating the HX-series model HXT070 (double pumps). If this value is set to 0h, the pump change will occur every 30 seconds. This is useful for testing and commissioning purposes because all shutoffs are also deactivated during these 30 seconds. The value, 169, will deactivate the attempt to change the pump and should be used when operating the HXS070.

**P2.10.12** is the parameter that sets the delay time between when the parameters are exceeded and the activation of a warning/shutdown. The value can be varied from 1 to 5 seconds. The default setting is 5 seconds. During commissioning and maintenance the value is to be set to 5 seconds.

**P2.11.1-8** are parameters for the Fieldbus (Profibus) output. The customer and/or end-user can choose any 8 of the NXP 0009 parameters to be sent out to a higher control system for external monitoring. The default values are as follows:

- P2.11.1, Primary side temperature from FTSA11 (°C)
- P2.11.2, HX pump motor speed (rpm)
- P2.11.3, HX pump motor current (A)
- P2.11.4, Primary side pump inlet pressure (bar)
- P2.11.5, Output frequency to HX pump motor (Hz)
- P2.11.6, Motor torque as % (+1000 equals +100%)
- P2.11.7, Motor shaft power in % (1000 equals 100%)
- P2.11.8, Fault (trip) history

P3.5 is the FV11 actuator reference temperature. Default value is 25 °C. This value is the liquid inlet temperature value to the main drives. More information can be found in chapter [3.3.6 Temperature set points](#).



Only an authorized person is allowed to make changes to the parameter settings. If the drive or HXT unit is malfunctioning or if they break due to a customer and/or end-user parameter setup error the warranty is not valid.

### 3.3.4 *General information about alarms and shutoff limits*

Apart from the standard NXP frequency converter alarms, found in the Vacon NXP User's Manual, the HX-unit application can generate alarms or shut-offs from one flow switch (FTSA11) with a built in analogue temperature transmitter, a pressure sensor (PT11) and one leak sensor (LS11). All alarm and shutoff limits have a default value. These default values should, if needed, be modified at the commissioning phase.



Refer to the Vacon NX USER'S MANUAL to change the parameters. Only authorized personnel are allowed to make modifications to the parameters.

The parameters and their settings can be found in chapter [3.3.2, Application parameter list](#). When you change the default settings during commissioning, you should write down the new setting including the date and your name to keep track of changes. Write down the new parameters to the custom setting column of the flow control parameter table 3.3-1.

### 3.3.5 *FTSA11 flow switch function*

The flow switch is set to shut down the HX-unit if the flow does not meet the requirements, refer to chapter [3.4.2, Adjusting the system flow and setting the switch point of the FTSA11](#). The unit settings should be modified, during commissioning, through the switch interface panel. The default setting for the switch is 50% (050).

Adjusting the FTSA11 flow switch:

1. Turn the pump power switch (the black and red switch in Figure 2.2-7) to the position "1" to connect the power to the HX-unit. This will activate the FTSA11.
2. When the power is connected, the display flashes for approximately 30 seconds with "888" for initialization. When the flashing stops, the device is ready for programming.

To change the parameters of the Uniflow SW6000 (Figure 3.3-1), the device has to be in setting mode. More information regarding the FTSA11 (Uniflow SW6000) flow switch can be found in the Component Specifications and Maintenance Instructions at the end of the Commissioning and Maintenance folder that is supplied with the HX-unit. Figure 3.3-2 shows the hierarchy of the parameters found in the FTSA11 flow switch. An example on how to edit the flow switch point is found in table 3.3-2.



Figure 3.3-1

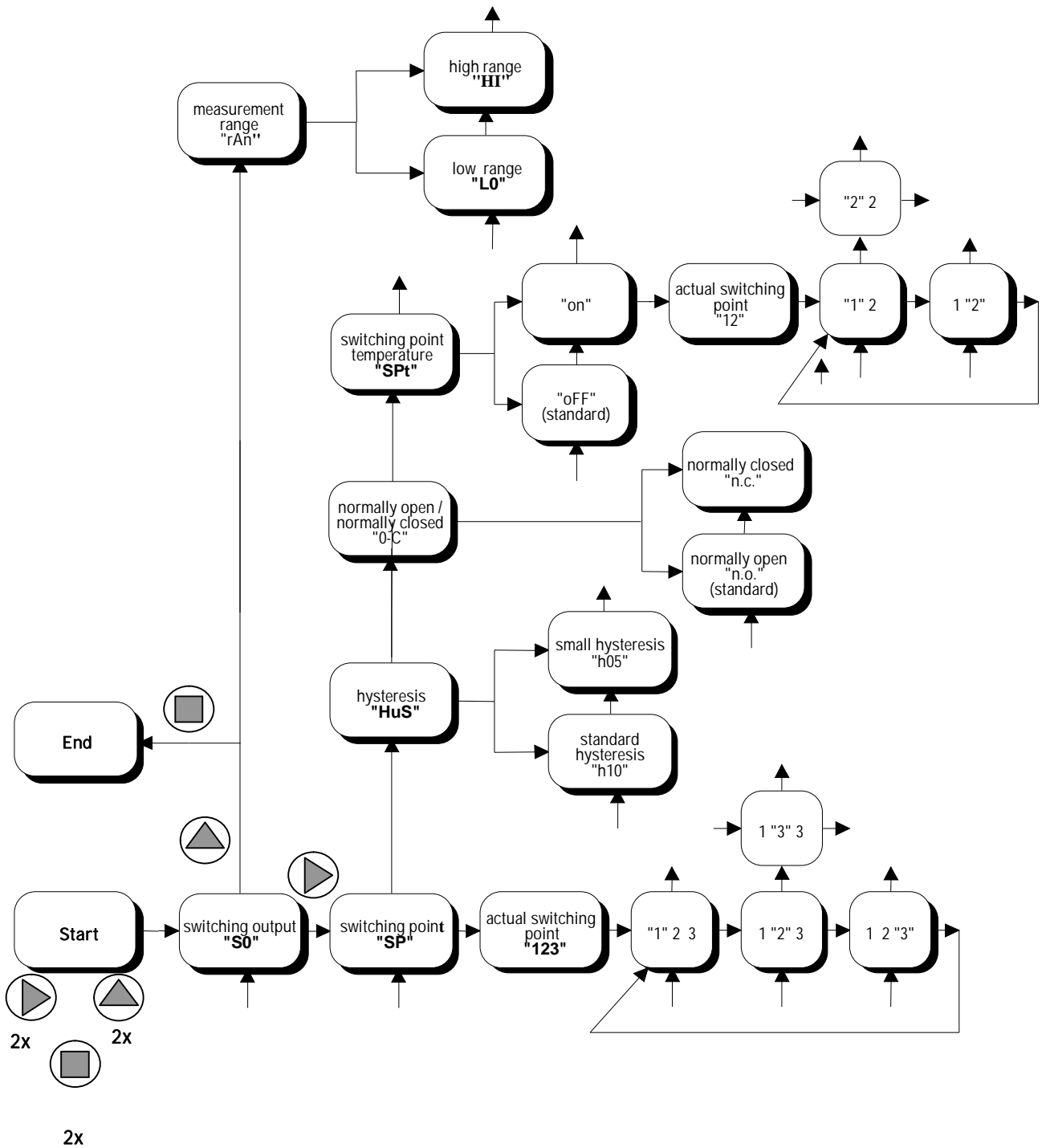

Figure 3.3-2 FTSA11 parameter hierarchy

Table 3.3-2 shows an example on how to set the flow switching point to 68.











Description	Push buttons	Display
1. Change to setting mode	2 x  , 2 x  , 2 x 	"SO" (switching output)
2.	1 x 	"SP" (switching point)
3.	1 x 	"050" (actual switching point)
4. Display hundred digit	1 x 	"050" (hundred digit is flashing)
5. Display ten digit	1 x 	"050" (ten digit is flashing)
6. Increase ten digit	1 x 	"060" (ten digit is flashing)
7. Display one digit	1 x 	"060" (one digit is flashing)
8. Increase one digit	8 x 	"068" (one digit is flashing)
9. Save new switching point	4 x 	"068", "SP", "SO", "123" (actual flow)

Table 3.3-2 Setting flow switching point

The settings on the FTSA11 should be the following:

- Measuring range, HI, high range 30 to 300 cm/s.
- Hysteresis, h05, 5% hysteresis.
- Switching order, n.c, normally closed.
- Temperature switch, OFF, no temperature switch point used.
- Flow switch point, according to calculations in chapter 3.4.2, [Adjusting the system flow and setting the switch point of the FTSA11](#).

### 3.3.6 Temperature set points

If the primary circuit temperature isn't set correctly the main drive might malfunction because of condensation. The default setting of the parameter P3.5 in the HX control unit application is 25°C. This means that the 3-way valve adjusts the flow in the primary circuit to keep the liquid temperature at 25°C (measured by the FTSA11 before the drives).

There are three factors that will affect the nominal temperature of the primary circuit:

- Ambient maximum temperature at the main drive installation
- Ambient maximum relative humidity at the main drive installation
- Secondary circuit maximum temperature

All of these factors have to be taken into consideration when calculating the primary circuit temperature set point.

- If the humidity is high, condensation will occur in the piping inside the main drives and therefore cause a malfunction.
- If the ambient temperature is too high the load of the drive must be reduced.
- And if the customer and/or end-user have an existing cooling system, which is going to be connected to the secondary circuit, the temperature of this circuit might be the deciding factor.

The primary circuit temperature is individual for every project. Here are three examples that show how the primary circuit temperature is calculated depending on which of the three above-mentioned factors is the deciding one:

### Example 1, high ambient temperature

If the customer and/or end-user have a high ambient temperature, 35°C, at the main drive that would require the primary circuit temperature to be equal or higher than 35°C. This would normally require a load reduction of the main drive. If the maximum relative humidity at the main drive is known, the dew-point chart (Chart 3.3-1) can be used to determine a more optimized temperature for the primary circuit.

Ambient temperature = 35°C

Maximum relative humidity = 60%

Acc. to chart 3.3-1 Dew point is @ 26°C

It is recommended to use a 2°C safety margin. Therefore the primary circuit temperature should in this case be set to 28°C (26°C +2°C). In this case no reduction of load in the main drive is needed, even if the ambient temperature is high, due to a rather low maximum relative humidity.

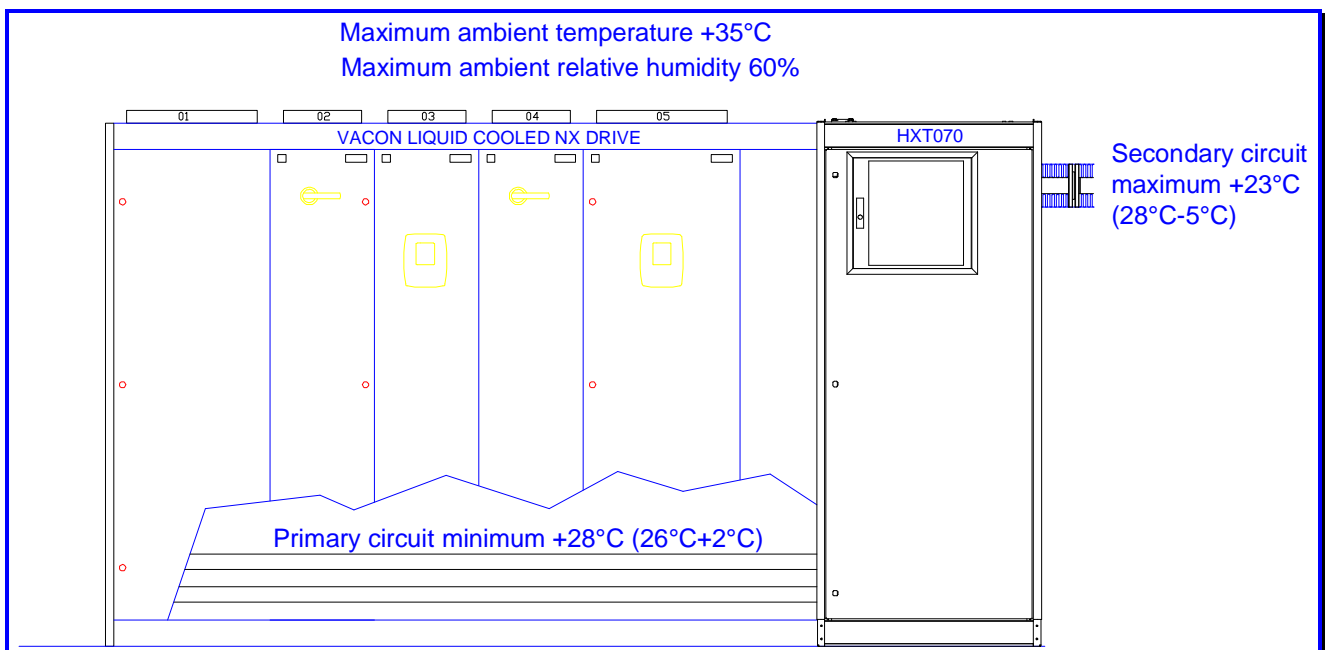

Figure 3.3-3 Example 1

The secondary circuit maximum temperature should always be 5°C lower than the primary circuit temperature to ensure a good thermal load transfer between the two circuits. In example 1 this means that the secondary circuit should be between +5...+23°C during operation. The 3-way valve will then keep the primary circuit temperature at 28°C regardless of the main drive load.

### Example 2, high ambient relative humidity

If the customer and/or end-user have a high ambient temperature, 40°C, at the main drives that would require the primary circuit temperature to be equal or higher than 40°C. This would normally require a significant load reduction of the main drive. If the maximum relative humidity at the main drive is known, the dew-point chart can be used to determine a more optimized temperature for the primary circuit.

Ambient temperature = 40°C

Maximum relative humidity = 80%

Acc. to chart 3.3-1 Dew point is @ 36°C



It is recommended to use a 2°C safety margin. Therefore the primary circuit temperature should in this case be set to 38°C (36°C +2°C). Using a 38°C temperature, instead of 40°C, on the primary circuit will reduce the required load reduction of the main drive. For more information regarding the load reduction of the drives refer to the Vacon NX Liquid Cooled User's Manual that is supplied with the main drive.

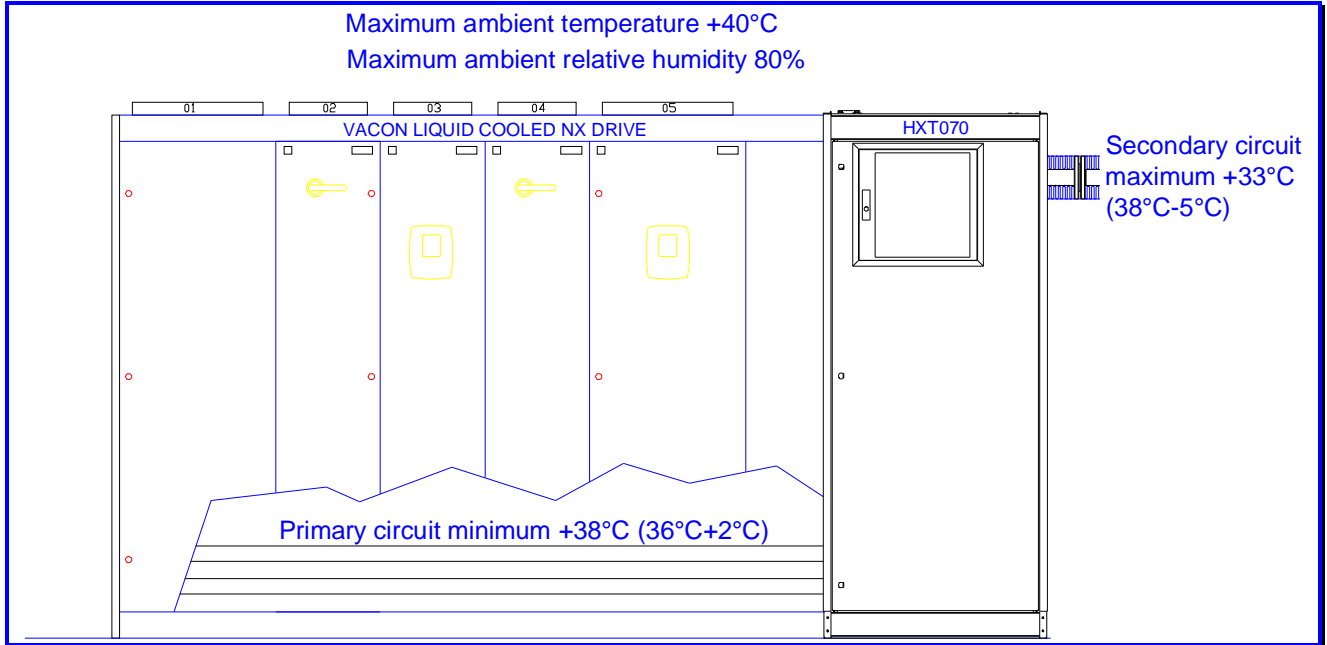

Figure 3.3-4 Example 2

The secondary circuit maximum temperature should always be 5°C lower than the primary circuit temperature to ensure a good thermal load transfer between the two circuits. In example 2 this means that the secondary circuit should be between +5...+33°C during operation. The 3-way valve will then keep the primary circuit temperature at 38°C regardless of the main drive load.

**Example 2b, reducing the ambient relative humidity**

If the load reduction isn't acceptable for the specified drive it is recommended that a humidity remover be installed that can reduce the maximum RH to an acceptable level. In example 2, a reduction of the maximum RH from 80% to 50% will allow the primary circuit temperature to be 30°C and therefore give the possibility to run the main drive at full load.

- Ambient temperature = 40°C
- Maximum relative humidity = ~~80%~~ 50%
- Acc. to chart 3.3-1 Dew point is @ 28°C

When adding the safety margin of 2°C the primary circuit temperature can be set to 30°C. In this case a reduction of the maximum RH from 80% to 50%, by using a humidity remover, will allow the primary circuit temperature to be set to 30°C therefore allowing the main drives to be run at full load.

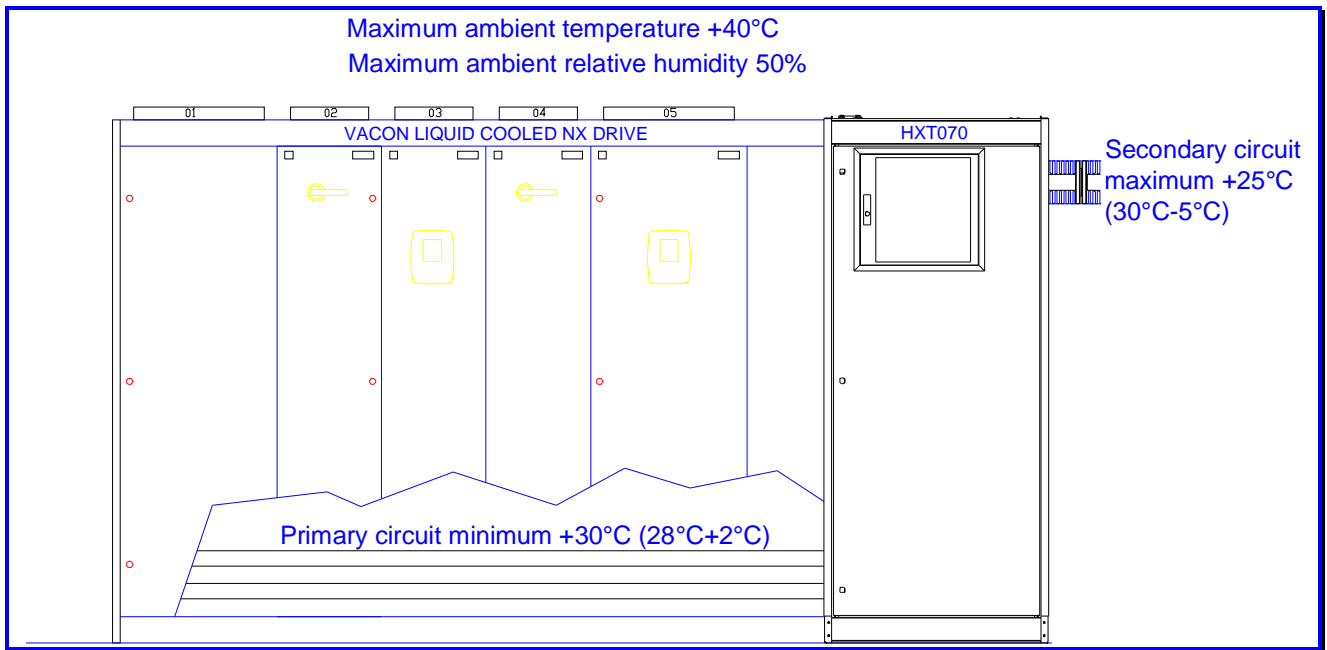

Figure 3.3-5 Example 2b

The secondary circuit maximum temperature should always be 5°C lower than the primary circuit temperature to ensure a good thermal load transfer between the two circuits. In example 2b this means that the secondary circuit should be between +5...+25°C during operation. The 3-way valve will then keep the primary circuit temperature at 30°C regardless of the main drive load.

### Example 3, high secondary circuit temperature

If the customer has an existing cooling system that delivers liquid at a temperature of 40°C then the primary circuit temperature has to be 5°C warmer to maintain a sufficient heat transfer between the primary and secondary circuit. This means that the primary circuit temperature cannot be colder than 45°C. This results in a significant reduction of the main drive load. In this case the only way of increasing the load of the main drive is to lower the temperature in the secondary circuit by installing additional coolers or a new cooling system with a lower water temperature. Next the dew point must be checked.

Secondary circuit maximum temperature = 40°C  
 Primary circuit maximum temperature = 45°C (40°C+5°C)  
 Ambient temperature = 30°C  
 Maximum relative humidity = 95%

Because the ambient temperature is beneath the primary circuit temperature there is no risk of condensation in the main drive.

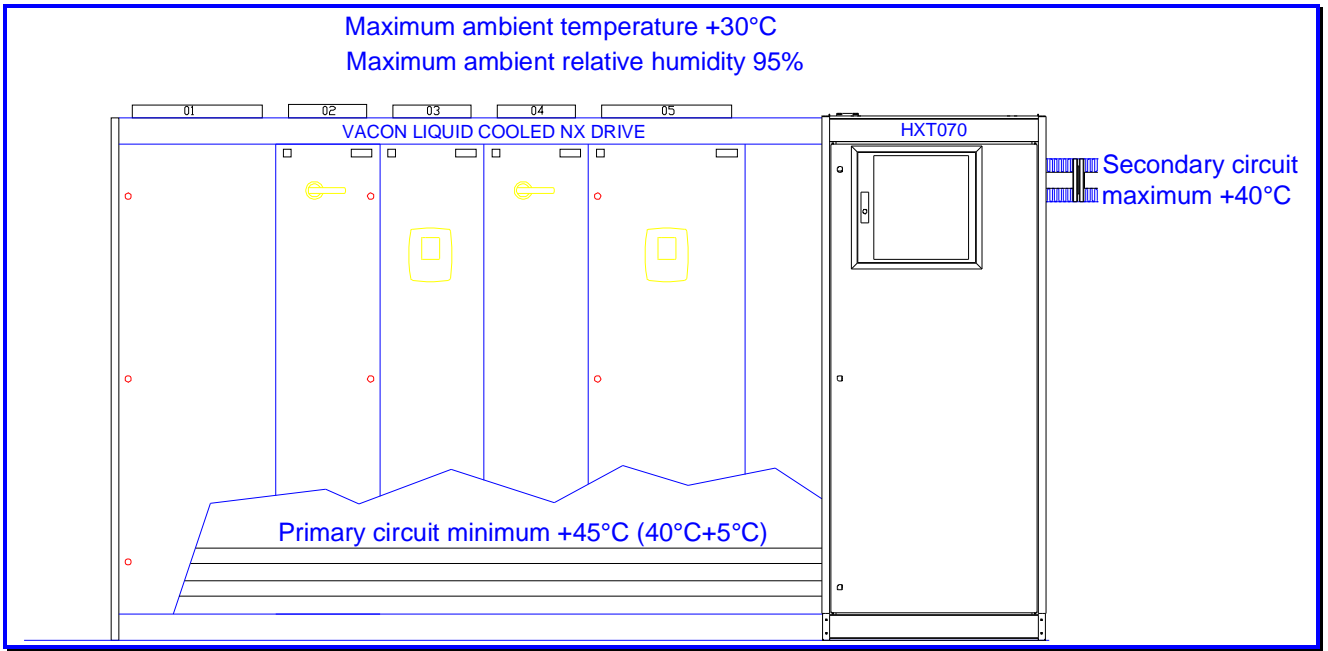

Figure 3.3-6 Example 3

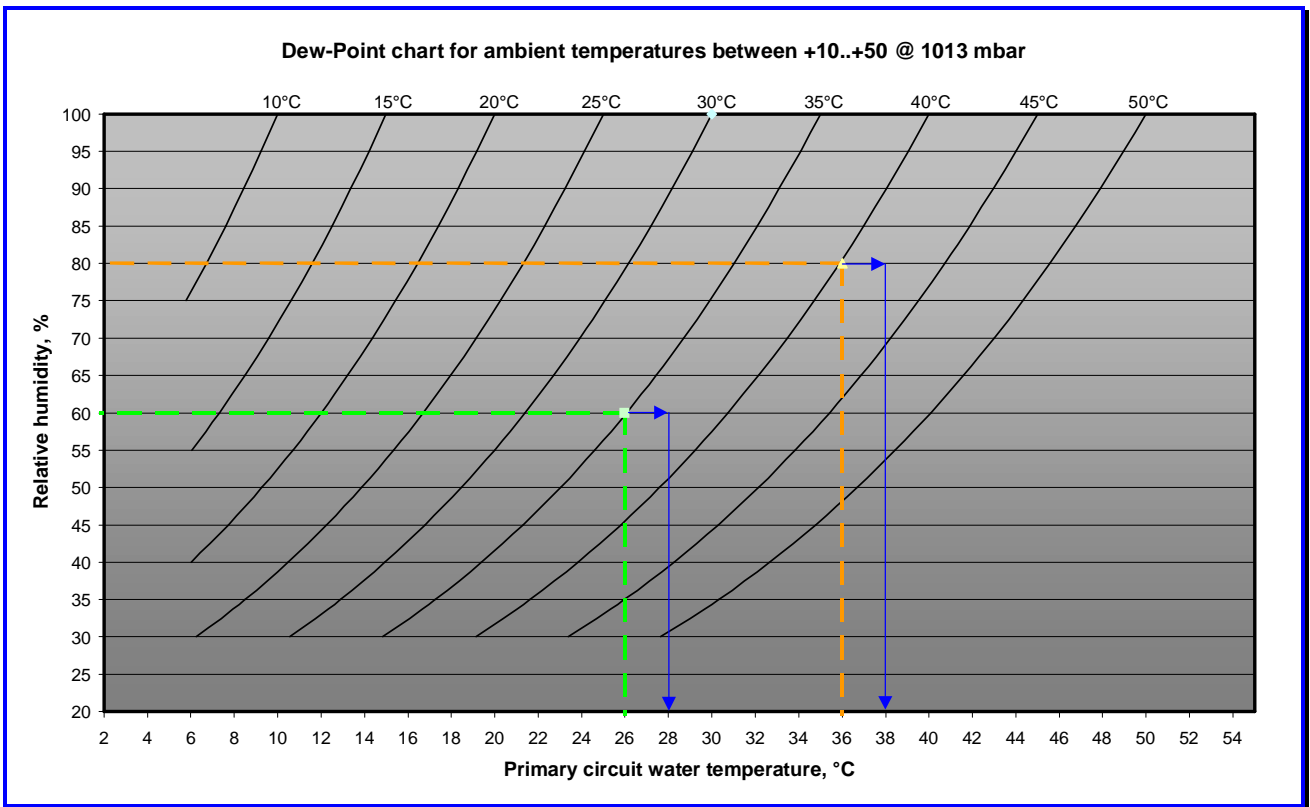

Chart 3.3-1 Dew-point chart

 <b>WARNING</b>	No condensation is allowed inside the main drive. If condensation occurs the warranty is no longer valid.
--------------------	---

Note that some Vacon liquid-cooled drives have a maximum ambient temperature of 40°C that would make a scenario with an ambient temperature over 40°C impossible. In a case like this it is recommended to add a water/air condenser with built in fan to reduce the temperature inside the main drive cubicle. If a water/air condenser is used to regulate the temperature inside the main drive cubicle the drive must be made airtight (e.g. IP54).

A last resort is to install an air conditioner that can regulate both the humidity and the temperature at the installation (electrical room). This is a safe but usually a very expensive option.

If the temperature of the liquid in the secondary circuit is lower than the room temperature, and the relative humidity is high, condensation might occur on the secondary circuit piping and the plate heat exchanger inside the HX-unit. This is not dangerous, however nor is it desirable. If there appears condensation inside the HX-unit it might trigger the leak sensor (LS11) on the HX-unit floor and therefore giving some 'false' leak alarms. In a case like this it is recommended that the customer insulate the secondary circuit piping and the plate heat exchanger inside the HX-unit to stop the condensation and therefore avoid any more 'false' alarms.

On request the HX-unit secondary circuit and the plate heat exchanger can be insulated before delivery.

### 3.3.7 *Temperature alarm settings*

The temperature alarm levels depend on the primary circuit temperature set point. Refer to chapter [3.3.6, Temperature set points](#).

The over temperature alarm

- Activates a function that will activate the yellow indicator light on the HX-unit electrical box. The value is set to 3°C higher than the primary circuit temperature set point. The default setting of the high-temperature shutoff is 28°C.
- When this alarm is activated the HX-control unit panel will show the text 'A83 OverTempA'.

#### **Example, over temperature alarm**

The primary circuit temperature set point is set to 35 degrees, then the over temperature alarm parameter (P2.10.9) should be set to 38 degrees.

The over temperature fault

- Activates a function that will shut down the drives but will keep the HX-unit running, is set to 10°C higher than the primary circuit temperature set point. The default setting of the high-temperature shutoff is 40°C.
- When this alarm is activated the HX-control unit panel will show the text 'A83 OverTempA'. And both the red and the yellow indicators on the electrical box will be active.

#### **Example, over temperature fault**

The primary circuit temperature set point is set to 35 degrees, then the over temperature fault parameter (P2.10.10) should be set to 45 degrees.

The HX-unit over temperature fault is designed to work as protection in case of a sudden change in the primary circuit for example if the flow in the secondary circuit for some reason is stopped.

The low temperature alarm

- Activates a function that will activate the yellow indicator light on the HX-unit electrical box. The parameter is set to 3°C lower than the primary circuit temperature set point. The default setting of the high-temperature shutoff is 22°C.
- When this alarm is activated the HX-control unit panel will show the text 'A86 LowTemp'.

#### Example, low temperature alarm

The primary circuit temperature set point is set to 35 degrees, and then the low temperature alarm should be set to 32 degrees.

#### Example, all temperature values

A primary circuit temperature set point of 35°C has been calculated for a specific installation. The temperature parameters should be adjusted the following way:

- The primary circuit temperature set point (parameter P3.5) is set to 35°C
- New over-temperature alarm value (parameter 2.10.9) 38°C
- New low-temperature alarm value (parameter 2.10.8) 32°C
- New over-temperature fault value (parameter 2.10.10) 45°C

The parameters are modified by using the HX Control box interface (Vacon NXP frequency converter panel). Instructions on how to access and modify the parameters can be found in the Vacon NXP User's Manual that is supplied with the HX-unit.

#### 3.3.8 Low pressure alarm

The function of the pressure sensor placed on the pump suction side is to give the user a warning of low pressure before the FTSA11 flow switch generates a sudden unwanted shutdown. If there is a leak in the primary circuit, outside of the HX-unit, the pressure starts to reduce in the system. The set point for the pressure sensor is 0.5 bar, so if the pressure on the primary circuit suction side goes under 0.5 bar the yellow indicator light on the electrical box will activate. The correct system pre-pressure is found in the chapter [3.1.6, Adding liquid and de-airing](#).

	<p>If the suction pressure in the primary circuit is reduced due to a leak, the flow in the circuit will within a short period of time be insufficient and therefore activate a FTSA11 flow switch shutdown.</p>
---	--

The low-pressure parameter number is P2.10.4. Follow the instructions in the Vacon NXP User's Manual on how to access and modify the parameters.

#### 3.3.9 Leak switch alarm specifications

The leak sensor is a free standing sensor on to the leakage plate in the floor of the HX-unit. The function of the switch is only to alert the user, by switching on the yellow alarm indicator placed on the control box. The leak sensor generates an alarm if there is liquid on the floor plate inside the HX-unit due to a leak in the unit. If there is condensation inside the HX-unit, the leak switch can generate 'false' leak alarms.

	<p>Note that no condensation is allowed. However, if the relative humidity within the cubicle is high and the ambient temperature is higher than the secondary circuit inlet temperature, condensation will occur on the secondary circuit piping.</p>
---	--

If the secondary circuit inlet liquid temperature is not temperature controlled by the customer, there is a risk of condensation on the secondary circuit inlet piping.

**Example:** If the secondary circuit liquid inlet is 10°C and the ambient relative humidity inside the HX-unit cubical is 25% with a temperature of 20°C, condensation starts to occur in the secondary circuit inlet piping. These values can be found on a Mollier diagram that shows the behaviour of moist air in normal (1.013 bar) pressure.

If any condensation occurs, the customer must add insulation on the HX11 heat exchanger and on the secondary circuit piping, or increase the temperature in the secondary circuit inlet liquid. The maximum temperature of the secondary circuit inlet liquid is 25°C without having to reduce the load in the main drive. More information regarding the secondary circuit temperature is found in chapter [3.3.6, Temperature set points](#).

### *3.3.10 Three-way valve actuator settings*

Please check that the SW-switch is in "normal" position in electronic positioner ES11. Installation instructions are found at the end of the HX-unit Commissioning and Maintenance folder that is supplied with the unit.

### 3.4 STEP 4, ADJUSTING THE FLOW

#### 3.4.1 Starting the pump

Note that de-airing of the unit has to be done before the HX-pump can be started. To start the pumps for the first time:



The pumps must not be run dry under any circumstances. Running the pump dry even for a short period of time might cause the shaft seal in the pump to start leaking.

1. Open the maintenance valves for the main drives (V310 to V31x) that are to be used.
2. Check that the valves V140...V143 are open and that V160 has the lever turned downwards.
3. Check that the valves V161...V162 and V210...V212 are closed. And that the pre-pressure is at 1.5 bar.
4. If the customer has added some valves these must also be checked.
5. Check that there are no visible leaks.
6. If the electrical cables have been connected and checked, refer to chapter [3.2 STEP 2, ELECTRICAL PART](#), turn the main power switch (the red / yellow switch in Figure 2.2-7) to position "1".
7. It is recommended that the parameter P2.10.1 be changed to 30 Hz at first start-up. Later when the HX-unit is completely de-aired the P2.10.1 should be set to the correct value, refer to chapter [3.4.2, Adjusting the system flow and setting the switch point of the FTSA11](#).
8. Start up the pump PU11 or PU12 by turning the pump control switch to position "1" (the black and red switch in Figure 2.2-7). The liquid starts to circulate in the primary circuit. Run the pump for max. 30 sec. then do the same to the other pump.
9. Wait for 5 min. and open the manual de-airing valve V162 to let out any air that might have been stuck in the pump housing.
10. Add water to get the pressure back up to 1.5 bars. Then start one of the pumps again and leave it running.
11. The LED-display on the FTSA11 should register that there is flow in the system. If not, stop the pump and re-check that all valves are open, e.g. in the drive section, in the HX-unit and if there is piping/valves made by customer in the primary circuit then check them also. The flow switch is set to 50% as default and has a 5 second delay (the 5 second delay is programmed into the HX control unit application). What this means is that the flow has to get over the 50% limit within 5 seconds of starting the pump, or the HX control unit will shut down the pump.
12. If the pump is shut down and the HX control unit display is registering a flow fault, reset the fault from the Vacon NXP control panel, turn the pump control switch back to position "0" and try again (refer to the NXP 'All in one' manual on how to work the panel). If the pump does not stay online after three (3) attempts, de-airing has not been done correctly or some of the valves mentioned in step 1 and 2 are still closed. De-air the system again; refer to Chapter [3.1.6 Adding liquid and de-airing](#).
13. Check that all valves except V161...V162, V210...V212 and V301...V302 are open. If the pump does not stay online after a new de-airing, try to temporarily lower the flow switching point for the FTSA11 to 10% (50% as default). Information on how to modify the FTSA11 switching point is found in chapter [3.3.5, FTSA11 flow switch function](#).

14. If the pump stays online, run it for 15 minutes and then change the flow switch point back to the project-specific setup value. The flow switch point can be changed during operation.

During the first days of operation, the pre-pressure decreases because some air might be left in the system after de-airing.

To adjust the pressure:

1. Connect a filling hose to valve V161. De-air the filling hose before adding liquid to avoid air getting into the primary circuit.
2. Add liquid to increase the pressure back to 1.5 bar on the PI11 pressure gauge.
3. Close valve V161 and remove the hose.

### 3.4.2 *Adjusting the system flow and setting the switch point of the FTSA11*

The pump flow should be adjusted according to the required flow of the connected drives. Before adjusting the flow, the primary circuit has to be correctly filled and de-aired. The target flow can be calculated by adding up the nominal flow for the main drives connected to the HX-unit. For information on how to calculate the optimum system flow see the example below. To adjust the system flow:

1. Start up the pump and run it at 50 Hz, which is the default value in the HX control unit application.
2. Check the actual flow speed in percent from the flow switch FTSA11 and convert it into l/min by using the converting formula.
3. Adjust the frequency of the pump to match the required total nominal flow + 10% (see example).

**Example:** If you are using 5 x Ch72 drive, the nominal flow according to the NX Liquid drive manual is 175 l/min. The flow should then be set to 'nominal flow' x 10%.

- Adjust the flow to 193 l/min (175 x 1.1) that is 53% according to the converting formula, by changing the frequency parameter P2.10.1 in the 'Flow control' part of the control unit application. The default value of the parameter is 50Hz. Reduce the frequency by 2 Hz at a time until the FTSA11 display shows the value ~53%. The value shown on the FTSA11 is somewhat irregular in the beginning.
- The setting point for FTSA11 should be set at the nominal required flow -10%. The nominal flow for a Ch72 is 175 l/min, therefore the switch point should be set to 158 l/min (175 x 0.9). From the converting formula we can establish that 158 l/min corresponds to 46% on the FTSA11. Information on how to modify the switch point of the FTSA11 is found in [chapter 3.3.5, FTSA11 flow switch function](#).
- If the actual flow goes under 41% (set point 46% - 5% hysteresis), the FTSA11 flow switch will open the switch (when the FTSA11 is set to 'normally closed', N.C). If the alarm disappears within 5 seconds, the control unit application filters out the alarm. If the alarm is still active after 5 seconds, the 'cooling OK' signal to the drives is disconnected, and both the HX-unit pump and the drives shut down.

Converting formula for the FTSA11 flow switch:

HXT070 AISI

$$\underline{x = 5 * y - 14.7} \quad (\Leftrightarrow \quad y = x / 5 + 14.7) \quad , \text{ where } y = \text{FTSA11 display (\%)} \\ x = \text{flow l/min}$$



### 3.4.3 Checklist before starting main NX drives

After the de-airing, when the control unit setup and the flow adjustment are performed and the HX-unit has been running for 30 minutes without any alarms, the main drive can be brought online. If there is more than one converter, it is recommended that they be started up one by one to avoid any sudden changes in the temperature. The load of the drives should also be increased step by step, otherwise the temperature might change too fast and cause an alarm, or in the worst case, a drive malfunction.

Before starting the drives:

1. Check that the HX-unit flow and temperature are within the given parameter values (no alarms).
2. Check that there is no air left in the plate heat exchanger by carefully opening the manual de-airing valve V162 and letting out a small amount (about 1 centilitre) of water.
3. Check that the PI11 pressure gauge is at about 1.5 bar.
4. Check that the maintenance valves to the converters (in use) V310...V31x are open.
5. Check that the flow (refer to FTSA11 converting formula above) is according to the connected converter requirements.
6. Check that the primary circuit temperature is according to the setup value.
7. Check that there is no condensation in the main drive cubical. If there is condensation inside the drive cubicles, the drives must be dried out before start-up.

After successfully performing the different steps of commissioning presented in chapter 3, the HX-unit and the connected drives are ready to be moved from the commissioning stage to operation mode. Troubleshooting information and unit service information is located in the last two chapters of this manual. For further information contact your local distributor.

## 4. UNIT MAINTENANCE

### 4.1 GENERAL MAINTENANCE

#### 4.1.1 *Renewing liquid in the primary circuit*

The liquid in the primary circuit should be renewed once every 5 years. The liquid in the primary circuit will be contaminated with particles from the different units and therefore the conductivity of the liquid will increase. When the conductivity of the liquid increases the risk of electrochemical reactions between the different alloys in the primary system also increases. Changing the liquid in the circuit every 5 years will reduce the risk of malfunction due to corrosion.

#### 4.1.2 *Maintenance schedule*

There are a few systematic maintenance tasks that have to be followed to ensure a trouble free operation of the HX-unit. They are presented in the diagram below:

		Once a month	Once a year	Every 2 years	Every 5 years
Checking / adding the expansion vessel pre-pressure	Air		x		
	Nitrogen			x	
Changing the primary circuit liquid					x
Monthly inspection		x			

Diagram 4.1-1 Maintenance schedule

The **monthly inspection** includes the following tasks:

- Opening the HX-unit cubicle door and checking that no visible leaks can be found. If a leak is found the unit has to be shut down and the leak repaired.
- Checking that the primary circuit pressure at the PI11 is between 1.0 and 1.5 bar. If the pressure is too low it must be rectified.
- Check that the FTSA11 flow switch LED display is reading the same value as lasting the previous month. If the flow switch is showing <5% reduction of the installed value (at commissioning) then refer to chapter 5.1.1, [Flow fault](#) for advice.
- Check the temperature of the primary circuit by pressing the button on the FTSA11 marked once. Check the temperature value with the value set at commissioning. Press it once more to go back to reading the flow percentage.

The indicator lights on the HX electrical box should be monitored at all time. If the HX-unit is placed at a position were it isn't possible to monitor the indicators continuously, the Fieldbus interface of the HX control box can used to re-route the alarms to a place were they are monitored at all times. If it isn't possible to use the Fieldbus interface then the indicators on the HX electrical box must be moved to a position were they can be monitored at all times.



## 4.2 MAINTENANCE BY COMPONENT

### 4.2.1 *Pump*

The pumps PU11/12 (refer to the P&ID) do not require regular service. During the life cycle of the HX-unit, it is likely that the shaft seal will have to be changed at some point. The shaft seal between the pump housing and the motor is the most probable cause for leak on the centrifugal pump. When changing the shaft seal, follow the pump maintenance rules in the pump service instructions found in the Commissioning and Maintenance folder that is supplied with the HX-unit.

It is recommended that a reserve pump be stored locally in order to restore the operation quickly when a pump needs to be maintained. There should also be a shaft seal in storage to facilitate changing a broken or leaking shaft seal at site.

When the pump is leaking, remove the broken pump and replace it with a reserve pump. The broken pump should be fixed immediately and stored for later use in case a similar pump failure occurs. Purchase a new shaft seal from the unit manufacturer, and keep this in storage as well.

 <p>WARNING</p>	<p>High-pressure hot coolant (6 bar, +60 °C) may be present in the primary cooling circuit. The coolant consists of liquid, propylene glycol and corrosion inhibitors, depending on the project. Glycol and corrosion inhibitors are damaging for the eyes. If you get coolant in your eyes, on your skin, or in your mouth, seek medical advice. <b>Use safety goggles.</b></p>
 <p>HOT SURFACE</p>	

To change a pump:

1. Check that it is safe to turn off the drives connected to the HX-unit, and that there is enough time reserved for the maintenance.
2. Prepare the HX-unit for liquid filling by connecting a hose to the filling valve (V161). Read Chapter 3.1.6, [Adding liquid and de-airing](#) before continuing.
3. Take the main drives connected to the HX-unit offline, according to the Vacon NX Liquid Cooled User's Manual.
4. Shut down the power to the HX-unit by first turning both the pump control switches to "0", therefore shutting down the pump, then turning the main power switch to position "0", refer to Figure 2.2-7.
5. Check that there is no power coming to the pumps by removing the cover of the pump electrical connection box and measuring the voltage. No work on the unit is allowed when the power is connected.
6. Disconnect the electrical cables from the pump that is to be changed. Write down the order of the phases for later use.
7. Close the maintenance valves of the pump that is to be maintained (V140-V143). Refer to the P&ID in Figure 2.2-2 or the project specific P&ID if one is available.

 <p>NOTE</p>	<p>If the liquid contains corrosion inhibitors or other additives then check national or local ecological directives for information on how to dispose of the drained liquid. Information regarding the recommended corrosion inhibitor Cortec is found in the end of the Commissioning and Maintenance folder that is supplied with the unit.</p>
---	--

8. Remove the bolts and nuts from the pump motor flange. Therefore leaving the pump housing in place (Figure 4.2-1). Note that there is a pre-pressure of 1.5 bars in the system; use safety goggles.
9. Lift out the pump from the HX-unit. Note the pump weight is about 50kg. It is recommended that there are two persons present when the pump is removed.
10. Perform the necessary maintenance on the pump and reconnect the pump to the pump housing. Or simply replace the pump if a spare pump is available.
11. Connect the electrical cables to the (new) pump motor.
12. Open the maintenance valves V140-V143.
13. Refill and de-air the pipes according to the instructions in [chapter 3.1.5](#) and [3.1.6](#).

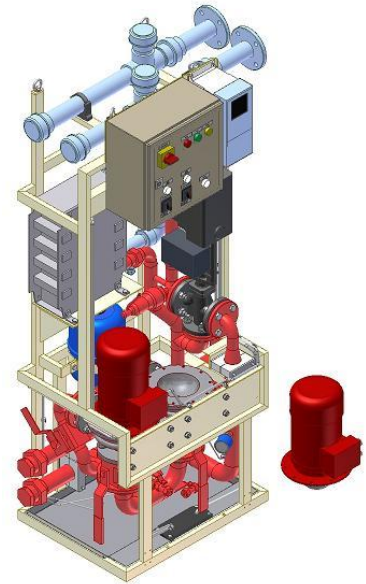

Figure 4.2-1

There are replacement parts available if there is a leak (e.g. shaft seal), or if the pumps are not able to keep sufficient pressure. Refer to the technical specifications of the pump for the replacement parts. The specifications can be found in the end of the Commissioning and Maintenance folder that is supplied with the HX-unit.

#### 4.2.2 Heat exchanger

The heat exchanger does not need regular service. If the primary circuit temperature is too high (high-temperature alarm is active), the flow is too low in one of the circuits or the temperature in the secondary circuit inlet is outside the defined parameter values. If the flow in the secondary circuit is too low, there may be some biological residue clogging the heat exchanger.

Because the primary circuit is filled with clean liquid, it is unlikely that the primary circuit's side of the heat exchanger clogs. Refer to the heat exchanger cleaning instructions found in the end of the Commissioning and Maintenance folder that is supplied with the HX-unit.

If the liquid used in the secondary circuit contains biological or chemical residue, it is recommended that a spare heat exchanger be stored locally. When the flow in the secondary circuit is too low, the HX-unit should be shut down and the heat exchanger replaced. The dirty heat exchanger should be cleaned according to manufacturer's instructions and placed in storage for the next time HX11 needs to be changed.

The HX11 can, if needed, be removed without removing the HX-unit from the cubicle:

1. Drain both the primary circuit and the secondary circuit. The secondary circuit is drained through the V220 valve (marked yellow in Figure 4.2-2). The primary circuit is drained through the valves V210 and V212 (marked green in Figure 4.2-2).
2. Disconnect the primary and secondary circuit connections (marked violet in Figure 4.2-2) from the unit. AISI pipe connections can be opened with a box wrench. PVC-C pipe connections can be opened by hand, or if needed use oil filter remover (used to remove the oil filter from cars). Be careful not to damage the connections.

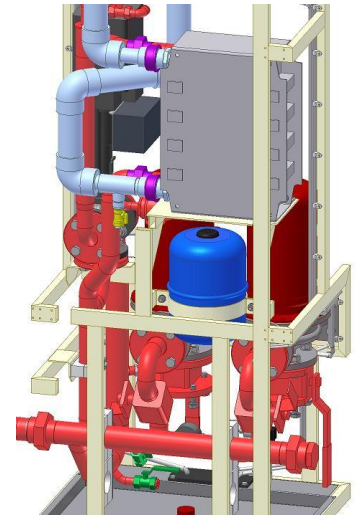

Figure 4.2-2

3. Remove the three heat exchanger fasteners, M10 screw connections (marked violet in Figure 4.2-3).
4. The plate heat exchanger weighs about 42 kg. Carefully pull / lift / turn out the HX11 (Figure 4.2-4).
5. Replace the unit with a clean one, or clean the unit according to the manufacturer's instructions found in the end of the Commissioning and Maintenance folder that is supplied with the HX-unit.

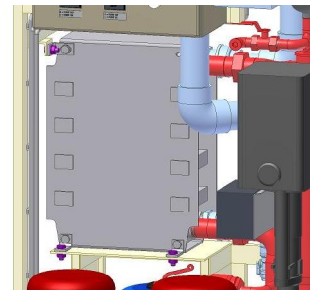

Figure 4.2-3

6. Connect the clean unit in reverse order using the instructions above. Add liquid and de-air the unit according to the instructions in [chapter 3.1.5](#) and [3.1.6](#).

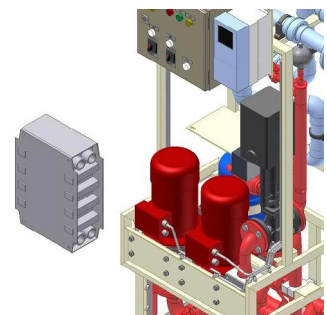

Figure 4.2-4

The manufacturer provides cleaning chemicals that improve the cleaning result. If the secondary liquid quality is bad, it is recommended that these chemicals, and a reserve plate heat exchanger, be kept in storage.

### 4.2.3 Pressure vessel

If the vessel is pre-pressured with nitrogen, the vessel pre-pressure needs to be checked every other year. If air is used as the pre-pressuring gas, it has to be checked once a year. In time, the gas escapes through the butyl rubber membrane into the liquid circuit, and gas or air must be added. The pre-pressure can be checked without draining the primary circuit.

It is recommended that this procedure be done during a yearly maintenance.



When performing maintenance work on a pressurized system generally acknowledged safety standards, EU directives and national regulations must also be followed. **Use safety goggles.**

To check the pre-pressure:

1. Remove the plug on valve V160 and replace it with a hose connector.
2. Place an eight (8) litre jar under the valve (if the expansion vessel air nozzle or membrane is broken there might be up to 8 litres in the vessel).
3. Turn the lever (marked yellow in Figure 4.2-5) on valve V160 90° so that it points away from you (points towards the back wall). This will close off the primary circuit and therefore only the liquid in the expansion vessel will come out. (There is line mark in the end of the stem, where you can also ensure the right position of the 3-way valve. This mark shows the open flow direction.)
4. When the pressure vessel is drained check the pre-pressure with a portable pressure gauge. The air nozzle can be found under the black rubber top on the vessel. The portable pressure gauge should have a similar interface to that used to fill a car tyre.

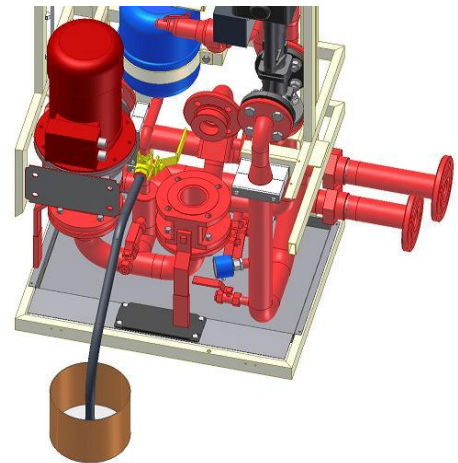

Figure 4.2-5

5. The pressure can be added with a nitrogen tank (pressure over 2 bar) or if air is used then a compressed air system or even a hand pump can be used.
6. Refill pressure if necessary. The pressure should be 100 kPa (1 bar). Use nitrogen if possible; otherwise air can also be used.
7. Reconnect the plug to valve V160, change the plug O-ring if necessary.
8. Turn back the lever on valve V160 90° so that it points down.
9. The pressure in the primary circuit will decrease due to the water that is removed during this process. Therefore water must be added through the filling valve V161 until the pressure on the pressure gauge (PI11) is back at 1.5 bar. Remember to de-air the filling hose before you connect it to valve V161, otherwise the air in the filling hose will enter the unit during filling.
10. Due to the small amount of liquid removed during this process it is not necessary to add any corrosion inhibitor.

## 5. TROUBLESHOOTING

### 5.1 Alarms and shutoffs

This chapter provides help in case the HX-control unit activates an alarm or fault. An alarm or fault is activated, because the HX-unit is working outside the parameter settings in the HX-control unit. The pre-set parameters for the HX-unit are shown in chapter [3.3.2, Application parameter list](#).

#### 5.1.1 Flow fault

If the **flow fault shutoff** is active (acc. To panel below) the HX-unit pump has stopped and the 'Cooling OK' signal to the main drive has been disconnected. The red indicator light on the electrical box door is also active. Check the following issues to solve why the alarm has been activated:

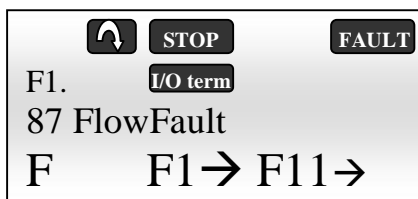

Figure 5.1-1, Flow fault on the NXP panel

Malfunction	Reasons for malfunction	Correction measures
The pre-pressure is too low in the primary circuit, i.e. below 0.5 bar.	<ul style="list-style-type: none"> <li>The pre-pressure in the expansion vessel EV11 has been reduced.</li> </ul>	<ul style="list-style-type: none"> <li>Check the EV11 pre-pressure and add pressure if necessary.</li> <li>Add pre-pressure to the primary circuit by adding liquid through valve V161.</li> </ul>
	<ul style="list-style-type: none"> <li>There is a leak in the primary circuit.</li> </ul>	<ul style="list-style-type: none"> <li>Check the primary circuit for leaks. If a leak is found the unit must be drained and the leak fixed before the unit is restarted.</li> </ul>
The pump isn't delivering enough pressure i.e. the flow is too low.	<ul style="list-style-type: none"> <li>A valve in the primary circuit is closed.</li> </ul>	<ul style="list-style-type: none"> <li>Check if any of the following valves in the primary circuit is closed (refer to the P&amp;ID):               <ul style="list-style-type: none"> <li>V140...143</li> <li>V310...3xx</li> <li>Any valves in the primary circuit added by the customer</li> </ul> </li> </ul>
	<ul style="list-style-type: none"> <li>The pump is broken.</li> </ul>	<ul style="list-style-type: none"> <li>Replace the broken pump.</li> </ul>
The FTSA11 is set incorrectly (this is a fault that is most likely to appear during maintenance or at the	<ul style="list-style-type: none"> <li>The flow requirement has changed after the commissioning stage.</li> </ul>	<ul style="list-style-type: none"> <li>Check the current flow requirements, they might have changed if e.g. a converter is taken offline (and its valves closed) because of maintenance.</li> </ul>

commissioning stage).	<ul style="list-style-type: none"><li>• The FTSA11 setup values have been poorly adjusted during commissioning.</li></ul>	<ul style="list-style-type: none"><li>• Check the required flow values for the converters and readjust the alarm set point on the FTSA11 (refer to chapter <a href="#">3.4.2 Adjusting the system flow and setting the switch point of the FTSA11</a>).</li></ul>
-----------------------	---	---

*Table 5.1-1, Flow fault detection*



### 5.1.2 Temperature alarms and shutoffs

If the **high temperature alarm** is active (acc. To panel below) the HX-unit is still online and the 'Cooling OK' signal to the main drive is connected. The yellow and green indicator lights on the electrical box door are also active. Check the following issues to solve why the alarm has been activated:

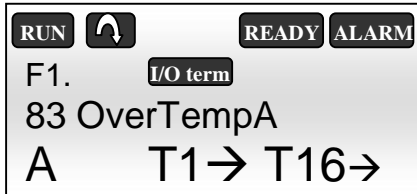

Figure 5.1-2, High temperature alarm on the NXP panel

Malfunction	Reasons for malfunction	Correction measures
The flow in the secondary circuit is too low.	<ul style="list-style-type: none"> <li>The customer filter, outside the HX-unit, MF21 (refer to the P&amp;ID) is clogged.</li> </ul>	<ul style="list-style-type: none"> <li>Clean the filter.</li> </ul>
	<ul style="list-style-type: none"> <li>The plate heat exchanger HX11 (refer to the P&amp;ID) is clogged on the secondary side.</li> </ul>	<ul style="list-style-type: none"> <li>Clean the heat exchanger. Refer to the cleaning instructions found in the HX-unit folder that is supplied with the unit. Instructions on how to remove the plate heat exchanger are found in chapter <a href="#">4.2.2, Heat exchanger</a>.</li> </ul>
	<ul style="list-style-type: none"> <li>The customer pump in the secondary circuit is malfunctioning and therefore not able to produce enough flow.</li> </ul>	<ul style="list-style-type: none"> <li>Maintain or replace the customer circuit pump.</li> </ul>
The temperature of the secondary circuit liquid is too high.	<ul style="list-style-type: none"> <li>Maintaining the HX-unit cannot solve the reason for this malfunction.</li> </ul>	<ul style="list-style-type: none"> <li>The temperature of the liquid in the secondary circuit inlet has to be 5 degrees lower than the primary circuit temperature set point, e.g. if the primary circuit temperature set point is set to 35°C then the secondary circuit inlet temperature must be 30°C or lower.</li> </ul>
The regulating valve V130 is malfunctioning	<ul style="list-style-type: none"> <li>The 3-way valve V130 is malfunctioning and therefore not directing enough flow through the plate heat exchanger to ensure a satisfactory heat transfer between the primary and secondary circuit.</li> </ul>	<ul style="list-style-type: none"> <li>If the 3-way valve or the valve actuator is malfunctioning it must be replaced.</li> </ul>

	<ul style="list-style-type: none"> <li>The FTSA11 setup values have been wrongly adjusted during commissioning.</li> </ul>	<ul style="list-style-type: none"> <li>Check the project parameters (refer Table 3.3-1, Parameter list) and compare it with the actual temperature.</li> </ul>
--	--	--

Table 5.1-2 High temperature fault detection

If the **high temperature shutoff** is active (same panel layout as high temperature alarm) the HX-unit is online but the 'Cooling OK' signal to the main drive has been disconnected. The yellow and red indicator lights on the electrical box door are active. The reasons for this shutoff are the same as for the high temperature alarm.

If the **low temperature alarm** is active (acc. To panel below) the HX-unit is still online and the 'Cooling OK' signal to the main drive is connected. The yellow and green indicator lights on the electrical box door are also active. Check the following issues to solve why the alarm has been activated:

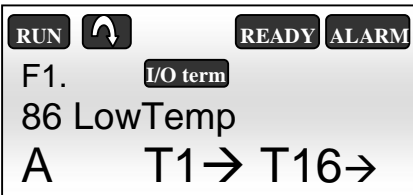

Figure 5.1-3, Low temperature alarm on the NXP panel

Malfunction	Reasons for malfunction	Correction measures
The regulating valve V130 (refer to the P&ID) is malfunctioning	<ul style="list-style-type: none"> <li>The 3-way valve V130 is malfunctioning and therefore directing too much flow through the plate heat exchanger.</li> </ul>	<ul style="list-style-type: none"> <li>If the 3-way valve or the valve actuator is malfunctioning it must be replaced.</li> </ul>
	<ul style="list-style-type: none"> <li>The inlet temperature on the secondary circuit is decreasing too fast, and the 3-way valve is not able to adjust the flow in the primary circuit fast enough.</li> </ul>	<ul style="list-style-type: none"> <li>Wait for two minutes and see if the alarm is reset automatically. If the alarm is active longer than two minutes, check the 3-way valve's function. If the 3-way valve or the valve actuator is malfunctioning it must be replaced. If the temperature in the primary circuit is too low it will result in condensation in the main drive section. No condensation is allowed.</li> <li>The temperature in the secondary circuit should not be allowed to decrease or increase too fast. A change of 1°C / minute should not be exceeded.</li> </ul>

<p>The FTSA11 (refer to the P&amp;ID) flow sensor with the analogical temperature outlet is malfunctioning.</p>	<ul style="list-style-type: none"><li>• The FTSA11 flow sensor with the analogical temperature outlet is broken.</li></ul>	<ul style="list-style-type: none"><li>• Check the temperature by comparing the FTSA11 temperature with the secondary circuit temperature indicator TI21. The temperature of FTSA11 should be higher than the TI21 temperature. Replace the FTSA11 if necessary.</li><li>• If a TI21 is not installed then check the primary circuit temperature (using a portable measuring device) and compare it to FTSA11. To get an accurate value the portable temperature gauge must be connected close to the FTSA11. Replace the FTSA11 if necessary.</li></ul>
---	--	---

*Table 5.1-3, Low temperature fault detection*

### 5.1.3 Low pressure alarm

If the **low pressure alarm** is active (acc. to panel below) the HX-unit is still online and the 'Cooling OK' signal to the main drive is connected. The yellow and green indicator lights on the electrical box door are also active. Check the following issues to solve why the alarm has been activated:

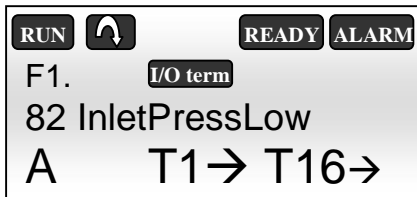

Figure 5.1-4, Low pressure alarm on the NXP panel

Malfunction	Reasons for malfunction	Correction measures
Leak in the primary circuit outside the HX-unit.	<ul style="list-style-type: none"> <li>Loose connection.</li> </ul>	<ul style="list-style-type: none"> <li>Tighten the connection until the leak stops. Add liquid to the primary circuit until the correct pre-pressure is reached. Follow the instructions in chapter 3.1.6, <a href="#">Adding liquid and de-airing</a>.</li> </ul>
	<ul style="list-style-type: none"> <li>Faulty connection.</li> </ul>	<ul style="list-style-type: none"> <li>Replace the broken parts. Then add liquid to the primary circuit until the correct pre-pressure is reached. Follow the instructions in chapter 3.1.6, <a href="#">Adding liquid and de-airing</a>.</li> </ul>
	<ul style="list-style-type: none"> <li>Hose failure in the main drive section.</li> </ul>	<ul style="list-style-type: none"> <li>Replace the hose. Refer to the NX Liquid Cooled User's Manual. Then add liquid to the primary circuit until the correct pre-pressure is reached. Follow the instructions in chapter 3.1.6, <a href="#">Adding liquid and de-airing</a>.</li> </ul>
Pressure vessel EV11 (refer to the P&ID) is without pre-pressure.	<ul style="list-style-type: none"> <li>The gas (air or nitrogen) has escaped through the butyl rubber membrane into the primary circuit.</li> </ul>	<ul style="list-style-type: none"> <li>Check and refill the pre-pressure according to the instructions in chapter 4.2.3 <a href="#">Pressure vessel</a>.</li> </ul>
	<ul style="list-style-type: none"> <li>The EV11 filling valve is broken and therefore letting out gas.</li> </ul>	<ul style="list-style-type: none"> <li>Replace the valve and refill the pre-pressure according to the instructions in chapter 4.2.3 <a href="#">Pressure vessel</a>.</li> </ul>
	<ul style="list-style-type: none"> <li>The butyl membrane inside the expansion vessel is broken.</li> </ul>	<ul style="list-style-type: none"> <li>Replace the expansion vessel and refill the pre-pressure according to the instructions in chapter 4.2.3 <a href="#">Pressure vessel</a>.</li> </ul>
Other reason.	<ul style="list-style-type: none"> <li>Faulty pressure sensor</li> </ul>	<ul style="list-style-type: none"> <li>Compare the value from the pressure gauge, PI11, with the value from the pressure transmitter PT11. If the pressure transmitter is broken it has to be replaced.</li> </ul>

Table 5.1-4, Pressure fault detection

### 5.1.4 Leak alarms

If the **leak alarm** is active (acc. to panel below) the HX-unit is still online and the 'Cooling OK' signal to the main drive is connected. The yellow and green indicator lights on the electrical box door are also active. Check the following issues to solve why the alarm has been activated:

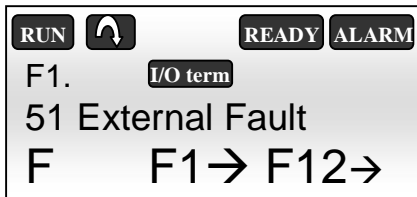

Figure 5.1-5, Leak alarm on the NXP panel

Malfunction	Reasons for malfunction	Correction measures
Leak	<ul style="list-style-type: none"> <li>Loose connection.</li> </ul>	<ul style="list-style-type: none"> <li>Tighten the connection until the leak stops. Add liquid to the primary circuit until the correct pre-pressure is reached. Follow the instructions in chapter 3.1.6, <a href="#">Adding liquid and de-airing</a>.</li> </ul>
	<ul style="list-style-type: none"> <li>Faulty connection.</li> </ul>	<ul style="list-style-type: none"> <li>Replace the broken parts. Then add liquid to the primary circuit until the correct pre-pressure is reached. Follow the instructions in chapter 3.1.6, <a href="#">Adding liquid and de-airing</a>.</li> </ul>
Condensation	<ul style="list-style-type: none"> <li>The secondary circuit liquid temperature is too low in regard to the ambient temperature and relative humidity.</li> </ul>	<ul style="list-style-type: none"> <li>If the cooling process allows it then increase the secondary circuit inlet liquid temperature until the condensation stops.</li> <li>Decrease the humidity or the temperature in the cubicle until the condensation stops.</li> <li>If there is condensation on the secondary circuit piping, insulate the secondary circuit pipes and the plate heat exchanger, HX11.</li> </ul>
Other reason	<ul style="list-style-type: none"> <li>No condensation or leak is found but the alarm is still active.</li> </ul>	<ul style="list-style-type: none"> <li>Try resetting the alarm on the reset switch. It is the push button in the lower right corner of the HX-unit electrical box door. Try to wipe off the sensor and the leakage plate with a dry cloth. If the yellow light is still on then the sensor is most likely broken and will need to be replaced.</li> </ul>

Figure 5.1-5, Leak fault detection

## 6. TECHNICAL SPECIFICATION

Physical size (without cubicle):

- Width, 705 mm (1005 mm)
- Height, 1872 mm
- Depth, 540 mm (603 mm)

Liquid connections:

- Primary circuit, Rp 2" (ISO 7/1) or DN50 DIN 2642
- Secondary circuit, DN50 DIN 2642

Electrical supply:

- 3 ~, 400VAC (50Hz) or 3 ~, 440VAC (60Hz), 16 A

Other electrical connection:

- 24V auxiliary voltage (between HX-unit and main drive)
- Option, Fieldbus (Profibus) connection from the HX-control unit to customer monitoring system

Ambient conditions:

- +5..+50°C
- RH 5..96%, no condensation allowed

Pressure ratings:

- Primary circuit, PN6
- Secondary circuit (customer piping), PN10

Temperature ratings:

- Primary circuit, +5..+50°C
- Secondary circuit, +5..+50°C

Storage temperature rating:

- -40..+60°C
- All liquid must be removed from the unit during storage if the temperature is below 0°C.

Cooling capacity:

- 69 kW

Rate of flow range: <sup>1)</sup>

- 120-200 l/min

Maximum input power:

- 3.6 kW

Supply pressure / Supply distance (primary circuit): <sup>2)</sup>

- 0.7 bar / 25 m + 25 m straight pipe <sup>3)</sup>

Liquid volume, primary side:

- 34 liter

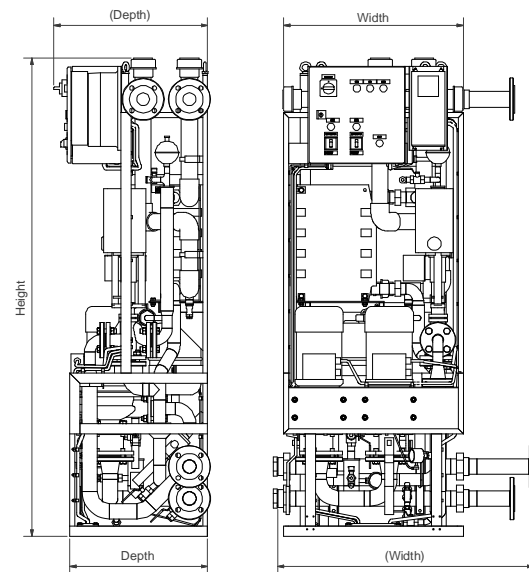

Concentration of glycol

- maximum 25%

Maximum flow secondary circuit:

- 200 l/min

1) Note! Combined nominal flow of frequency converters must not exceed 90% of the maximum rate of flow.

2) Maximum straight pipe distance between HX-unit and drive for achieving maximum flow. Elbows and other components will reduce the pipe distance.

3) Pipeline to frequency converter (25 m) and back (25 m).









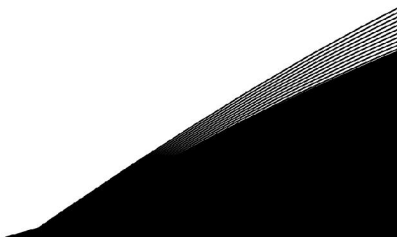



Vaasa  
Vacon Oyj (Headquarters and Production)  
Runsorintie 7, 65380 Vaasa  
firstname.lastname@vacon.com  
tel. +358 (0) 201 2121  
fax: +358 (0) 201 212 205

Helsinki  
Vacon Oyj  
Äyritie 12, 01510 Vantaa  
tel. +358 (0)201 212 600  
fax: +358 (0)201 212 699

Tampere  
Vacon Oyj  
Alasniitynkatu 30, 33700 Tampere  
tel. +358 (0)201 2121  
fax: +358 (0)201 212 750

Rotatek Finland Oy  
Laserkatu 6, 53850 Lappeenranta  
tel. +358 (0)5 6243 870  
fax: +358 (0)5 6243 871

Vacon Traction Oy  
Alasniitynkatu 30, 33700 Tampere  
tel. +358 (0)201 2121  
fax: +358 (0)201 212 710

sales companies and representative offices:

Austria  
Vacon AT Antriebssysteme GmbH  
Aumühlweg 21  
2544 Leobersdorf  
vacon.austria@vacon.com  
tel. +43 2256 651 66  
fax: +43 2256 651 66 66

Belgium  
Vacon Benelux NV/SA  
Interleuvenlaan 62  
3001 Heverlee (Leuven)  
info@vacon.be  
tel. +32 (0)16 394 825  
fax: +32 (0)16 394 827

France  
Vacon France s.a.s.  
Batiment le Sextant  
462 rue Benjamin Delessert  
ZI de Moissy Cramayel  
BP 83  
77 554 Moissy Cramayel  
www.vacon-france.fr  
tel. +33 (0)1 64 13 54 11  
fax: +33 (0)1 64 13 54 21

Germany  
Vacon GmbH  
Gladbecker Str. 425  
45329 Essen  
tel. +49 (0)201/80670-0  
fax: +49 (0)201/80670-93

Great Britain  
Vacon Drives (UK) Ltd.  
Unit 11, Sunnyside Park  
Wheatfield Way, Hinckley  
LE10, 1PJ, Leicestershire  
vacon.uk@vacon.com  
tel. +44 (0)1455 611 515  
fax: +44 (0)1455 611 517

Italy  
Vacon S.p.A.  
Via F.lli Guerra, 35  
42100 Reggio Emilia  
info@vacon.it  
tel. +39 0522 276811  
fax: +39 0522 276890

The Netherlands  
Vacon Benelux BV  
Weide 40, 4206 CJ Gorinchem  
vacon.benelux@vacon.com  
tel. +31 (0)183 642 970  
fax: +31 (0) 183 642 971

Norway  
Vacon AS  
Langgata 2  
3080 Holmestrand  
vacon@vacon.no  
tel. +47 330 96120  
fax: +47 330 96130

PR China  
Vacon Plc  
Beijing Representative Office  
A205, Grand Pacific Garden Mansion  
8A Guanhua Road  
Beijing 100026  
www.vacon.com.cn  
vacon.china@vacon.com  
tel. +86 10 6581 3734  
fax: +86 10 6581 3754

Russia  
ZAO Vacon Drives  
Bolshaja Jakimanka 31  
stroenie 18  
109180 Moscow  
www.ru.vacon.com  
tel. +7 (095) 974 1541  
fax: +7 (095) 974 1554  
ZAO Vacon Drives  
2ya Sovetskaya 7, office 210A  
191036 St. Petersburg  
www.ru.vacon.com  
tel. +7 (812) 332 1114  
fax: +7 (812) 279 9053

Singapore  
Vacon Plc  
Singapore Representative Office  
102F Pasir Panjang Road  
#02-06 Citilink Warehouse Complex  
Singapore 118530  
vacon.singapore@vacon.com  
tel. +65 6278 8533  
fax: +65 6278 1066

Spain  
Vacon Drives Ibérica S.A.  
Miquel Servet, 2. P.I. Bufalvent  
08240 Manresa  
www.vacon.es  
info@vacon.es  
tel. +34 93 877 45 06  
fax: +34 93 877 00 09

Sweden  
Vacon AB  
Torget 1  
172 67 Sundbyberg  
tel. +46 (0)8 293 055  
fax: +46 (0)8 290 755

Vacon distributor: